

**Agilent E5061A/E5062A ENA Series
ENA Series RF Network Analyzers**

Programmer's Guide

Third Edition

FIRMWARE REVISIONS

This manual applies directly to instruments that have the firmware revision A.02.10.
For additional information about firmware revisions, see Appendix A.



Agilent Part No. E5061-90022

June 2006

Notices

The information contained in this document is subject to change without notice.

This document contains proprietary information that is protected by copyright. All rights are reserved. No part of this document may be photocopied, reproduced, or translated to another language without the prior written consent of Agilent Technologies.

Microsoft®, MS-DOS®, Windows®, Visual C++®, Visual Basic®, VBA® and Excel® are registered

UNIX is a registered trademark in U.S. and other countries, licensed exclusively through X/Open Company Limited.

Portions ©Copyright 1996, Microsoft Corporation. All rights reserved.

© Copyright 2004, 2005, 2006 Agilent Technologies

Manual Printing History

The manual's printing date and part number indicate its current edition. The printing date changes when a new edition is printed. (Minor corrections and updates that are incorporated at reprint do not cause the date to change.) The manual part number changes when extensive technical changes are incorporated.

February 2004	First Edition (part number: E5061-90002)
September 2005	Second Edition (part number: E5061-90012, changes for firmware version A.02.00)
June 2005	Third Edition (part number: E5061-90022, changes for firmware version A.02.10)

Typeface Conventions

Bold	Boldface type is used when a term is defined. For example: icons are symbols.
<i>Italic</i>	Italic type is used for emphasis and for titles of manuals and other publications.
[Key]	Indicates the hardkey whose key label is Key.
[Key] - Item	Indicates a series of key operations in which you press the [Key] key, select (highlight) the item called Item on the displayed menu using the [↓] key and so on, and then press the [Enter] key.

Sample Program Disk

A sample program disk (Agilent part number: E5061-180x0) is furnished with this manual. The disk contains the sample programs used in this manual.

The customer shall have the personal, non-transferable rights to use, copy, or modify SAMPLE PROGRAMS in this manual for the customer's internal operations. The customer shall use the SAMPLE PROGRAMS solely and exclusively for their own purposes and shall not license, lease, market, or distribute the SAMPLE PROGRAMS or modification of any part thereof.

Agilent Technologies shall not be liable for the quality, performance, or behavior of the SAMPLE PROGRAMS. Agilent Technologies especially disclaims any responsibility for the operation of the SAMPLE PROGRAMS to be uninterrupted or error-free. The SAMPLE PROGRAMS are provided AS IS.

AGILENT TECHNOLOGIES DISCLAIMS ANY IMPLIED WARRANTY OF MERCHANTABILITY AND FITNESS FOR A PARTICULAR PURPOSE.

Agilent Technologies shall not be liable for any infringement of any patent, trademark, copyright, or other proprietary right by the SAMPLE PROGRAMS or their use. Agilent Technologies does not warrant that the SAMPLE PROGRAMS are free from infringements of such rights of third parties. However, Agilent Technologies will not knowingly infringe or deliver software that infringes the patent, trademark, copyright, or other proprietary right of a third party.

Documentation Map

The following manuals are available for the Agilent E5061A/E5062A.

- ***User's Guide (Part Number E5061-900x0, attached to Option ABA)***

This manual describes most of the basic information needed to use the E5061A/E5062A. It provides a function overview, detailed operation procedure for each function (from preparation for measurement to analysis of measurement results), measurement examples, specifications, and supplemental information. For programming guidance on performing automatic measurement with the E5061A/E5062A, please see the *Programming Manual*.

- ***Installation and Quick Start Guide (Part Number E5061-900x1, attached to Option ABA)***

This manual describes installation of the instrument after it is delivered and the basic procedures for applications and analysis. Refer to this manual when you use the E5061A/E5062A for the first time.

- ***Programmer's Guide (Part Number E5061-900x2, attached to Option ABA)***

This manual provides programming information for performing automatic measurement with the E5061A/E5062A. It includes an outline of remote control, procedures for detecting measurement start (trigger) and end (sweep end), application programming examples, a command reference, and related information.

- ***VBA Programmer's Guide (Part Number E5061-900x3, attached to Option ABA)***

This manual describes programming information for performing automatic measurement with internal controller. It includes an outline of VBA programming, some sample programming examples, a COM object reference, and related information.

- ***Option 100 Fault Location and Structural Return Loss Measurement User's Guide Supplement (Part Number E5061-900x4, attached to Option 100)***

This manual describes information for using the fault location and structural return loss measurement functions.

NOTE

The number position shown by "x" in the part numbers above indicates the edition number. This convention is applied to each manual, CD-ROM (for manuals), and sample programs disk issued.

1. Making Effective Use of This Manual	
Contents of This Manual	18
How To Use This Manual	20
Looking up SCPI commands	20
Using sample programs	21
2. Overview of Remote Control	
Types of remote control system	24
GPIB remote control system	25
What is GPIB?	25
System configuration	25
Device selector	26
LAN remote control system	27
System configuration	27
Control over SICL-LAN server	28
Control over telnet server	31
Sending SCPI command messages	34
Types and structure of commands	34
Grammar of messages	35
Remote mode	36
3. Setting Up the Analyzer	
Selecting the Active Channel/Trace	38
Configuring Measurement Conditions	39
Setting the Number of Traces	39
Selecting Measurement Parameters	39
Setting the Sweep Condition (Stimulus)	39
Configuring Averaging Settings	41
Setting the System Z0	41
Configuring Display Settings	42
Setting the Layout of Windows and Graphs	42
Configuring Trace Display Settings	45
Printing a Message in the Echo Window	47
Turning On or Off Display Update	47
Showing/Hiding Frequencies	47
Showing or Hiding the Title	47
Configuring Date/Time Display	47
Turning On or Off the LCD Backlight	47
Setting display colors	48
Saving and Loading the Settings	49
Sample Program	50
4. Performing a Calibration	
Calibration	58
Performing a Calibration (Obtaining the Calibration Coefficients)	58
Defining Calibration Kits	62
Saving and Loading Calibration Coefficients	64
Sample Program	65

Contents

Calibration	65
ECal	73
5. Making a Measurement	
Trigger system	78
System-wide state and transition	79
Channel-wide state and transition	80
Starting a Measurement Cycle (Triggering the instrument)	81
Configuring the Instrument to Automatically Perform Continuous Measurement	81
Starting Measurement on Demand	81
Waiting for the End of Measurement	82
Using the Status Register	82
Using the :TRIG:SING Command	85
Using Wait Time	86
6. Analyzing Data	
Retrieving Measurement Results at Specified Points	88
Showing/Hiding Markers	88
Turning On or Off Reference Marker Mode	88
Setting (Changing) and Retrieving Stimulus Value at Marker Positions	88
Retrieving Measurement Results at Marker Positions	88
Searching for Positions That Match Specified Criteria	89
Using Marker Search	89
Using the Analysis Command	91
Sample Program	93
Bandwidth Search	95
Setting the Bandwidth Definition Value	95
Retrieving Bandwidth Search Results	95
Sample Program	95
Notch search	97
Setting the notch definition value	97
Reading out the notch search result	97
Statistical Analysis	98
Analyzing impedance	99
7. Reading/Writing Measurement Data	
Data Transfer Format	102
ASCII Transfer Format	103
Binary Transfer Format	104
Internal data processing	106
Data flow	106
Internal data arrays	106
Retrieving Measurement Results	109
Retrieving Internal Data Arrays	109
Entering Data into a Trace	113
8. Limit Test	
Performing a Limit Test	118

Configuring Limit Lines	118
Showing/Hiding Limit Lines	118
Turning On or Off the Limit Test Feature	118
Showing/Hiding “Fail”	118
Obtaining Test Results	119
Test Results at Each Measurement Point	119
Test Results for Each Trace	119
Test Results for Each Channel	120
Overall Test Result	122
Sample Program	123
9. Saving and Recalling (File Management)	
Saving and Recalling File	130
Specifying file	130
Saving and recalling instrument status	130
Saving measurement data	131
Saving the images on the LCD screen	131
Saving and recalling the segment sweep table	132
Saving and recalling the limit table	132
Saving/loading (importing) the VBA program	132
Sample program	134
Managing Files	137
Creating directory (folder)	137
Deleting file (directory)	137
Copying file	137
Transferring files	137
Retrieving data from storage	137
Sample program	138
10. Communication with External Instruments Using Handler I/O Port	
Handler I/O Port Overview	146
I/O Signal Pin Layout and Description	147
Inputting/Outputting Data	150
Specifying signal direction of port	150
Reading data input to port	151
Data output to port	151
Preset states at power-on	152
Timing Chart	153
Electrical Characteristics	156
Input signal	156
Output signal	157
Power supply (+5 V)	157
Sample Program	158
11. Working with Automatic Test Systems	
Preventing Erroneous Key Operation on the Front Panel (Key Lock Feature)	160
Improving Command Processing Speed	161
Measurement results (trace) need not to be updated	161

Measurement results (trace) need to be updated.	161
Sample program	162
Detecting Occurrence of an Error.	164
Using the status reporting system	164
Using the error queue	164
Sample program	165
12. Sample Application Programs	
Basic measurement (measuring a band pass filter)	168
Controlling Using SICL-LAN Server	174
Using VBA macro	174
Description of operation in VBA macro.	175
Controlling Using Telnet Server.	182
Using VBA macro	182
Description of operation in VBA macro.	183
13. SCPI Command Reference	
Notational conventions in this command reference	192
Syntax	192
Description	192
Parameters.	193
Query response	193
Related commands	193
Equivalent key	193
IEEE Common Commands	194
*CLS	194
*ESE	195
*ESR?	195
*IDN?	196
*OPC	196
*OPC?	196
*OPT?	197
*RST	197
*SRE	198
*STB?	199
*TRG	199
*WAI	199
E5061A/E5062A commands	200
:ABOR	200
:CALC{1-4}:BLIM	201
:CALC{1-4}:BLIM:DB	202
:CALC{1-4}:BLIM:DISP:MARK	203
:CALC{1-4}:BLIM:DISP:VAL	204
:CALC{1-4}:BLIM:FAIL?	205
:CALC{1-4}:BLIM:MAX	206
:CALC{1-4}:BLIM:MIN	207
:CALC{1-4}:BLIM:REP?	208
:CALC{1-4}:CONV	209

:CALC{1-4}:CONV:FUNC	210
:CALC{1-4}:CORR:EDEL:TIME	211
:CALC{1-4}:CORR:OFFS:PHAS	212
:CALC{1-4}:DATA:FDAT	213
:CALC{1-4}:DATA:FMEM	214
:CALC{1-4}:DATA:SDAT	215
:CALC{1-4}:DATA:SMEM	216
:CALC{1-4}:FORM	217
:CALC{1-4}:FUNC:DATA?	219
:CALC{1-4}:FUNC:DOM	220
:CALC{1-4}:FUNC:DOM:COUP	221
:CALC{1-4}:FUNC:DOM:STAR	222
:CALC{1-4}:FUNC:DOM:STOP	223
:CALC{1-4}:FUNC:EXEC	223
:CALC{1-4}:FUNC:PEXC	224
:CALC{1-4}:FUNC:POIN?	225
:CALC{1-4}:FUNC:PPOL	226
:CALC{1-4}:FUNC:TARG	227
:CALC{1-4}:FUNC:TTR	228
:CALC{1-4}:FUNC:TYPE	229
:CALC{1-4}:LIM	230
:CALC{1-4}:LIM:DATA	231
:CALC{1-4}:LIM:DISP	233
:CALC{1-4}:LIM:DISP:CLIP	234
:CALC{1-4}:LIM:FAIL?	235
:CALC{1-4}:LIM:OFFS:AMPL	236
:CALC{1-4}:LIM:OFFS:MARK	237
:CALC{1-4}:LIM:OFFS:STIM	238
:CALC{1-4}:LIM:REP:ALL?	239
:CALC{1-4}:LIM:REP?	240
:CALC{1-4}:LIM:REP:POIN?	240
:CALC{1-4}:MARK:BWID	241
:CALC{1-4}:MARK:COUP	242
:CALC{1-4}:MARK:FUNC:DOM	243
:CALC{1-4}:MARK:FUNC:DOM:COUP	244
:CALC{1-4}:MARK:FUNC:DOM:STAR	245
:CALC{1-4}:MARK:FUNC:DOM:STOP	246
:CALC{1-4}:MARK:FUNC:MULT:PEXC	247
:CALC{1-4}:MARK:FUNC:MULT:PPOL	248
:CALC{1-4}:MARK:FUNC:MULT:TARG	249
:CALC{1-4}:MARK:FUNC:MULT:TRAC	250
:CALC{1-4}:MARK:FUNC:MULT:TTR	251
:CALC{1-4}:MARK:FUNC:MULT:TYPE	252
:CALC{1-4}:MARK:MATH:FLAT	253
:CALC{1-4}:MARK:MATH:FLAT:DATA?	254
:CALC{1-4}:MARK:MATH:FST	255
:CALC{1-4}:MARK:MATH:FST:DATA?	256
:CALC{1-4}:MARK:MATH:STAT	257
:CALC{1-4}:MARK:MATH:STAT:DATA?	258

Contents

:CALC{1-4}:MARK:NOTC	259
:CALC{1-4}:MARK:REF	260
:CALC{1-4}:MARK{1-10}	261
:CALC{1-4}:MARK{1-10}:ACT	262
:CALC{1-4}:MARK{1-10}:BWID:DATA?	263
:CALC{1-4}:MARK{1-10}:BWID:THR	264
:CALC{1-4}:MARK{1-10}:DISC	265
:CALC{1-4}:MARK{1-10}:FUNC:EXEC	266
:CALC{1-4}:MARK{1-10}:FUNC:PEXC	267
:CALC{1-4}:MARK{1-10}:FUNC:PPOL	268
:CALC{1-4}:MARK{1-10}:FUNC:TARG	269
:CALC{1-4}:MARK{1-10}:FUNC:TRAC	270
:CALC{1-4}:MARK{1-10}:FUNC:TTR	271
:CALC{1-4}:MARK{1-10}:FUNC:TYPE	272
:CALC{1-4}:MARK{1-10}:NOTC:DATA?	274
:CALC{1-4}:MARK{1-10}:NOTC:THR	275
:CALC{1-4}:MARK{1-10}:SET	276
:CALC{1-4}:MARK{1-10}:X	277
:CALC{1-4}:MARK{1-10}:Y?	278
:CALC{1-4}:MATH:FUNC	279
:CALC{1-4}:MATH:MEM	279
:CALC{1-4}:MST	280
:CALC{1-4}:MST:DATA?	281
:CALC{1-4}:PAR:COUN	282
:CALC{1-4}:PAR{1-4}:DEF	283
:CALC{1-4}:PAR{1-4}:SEL	284
:CALC{1-4}:RLIM	284
:CALC{1-4}:RLIM:DATA	285
:CALC{1-4}:RLIM:DISP:LINE	286
:CALC{1-4}:RLIM:DISP:SEL	287
:CALC{1-4}:RLIM:DISP:VAL	288
:CALC{1-4}:RLIM:FAIL?	289
:CALC{1-4}:RLIM:REP?	290
:CALC{1-4}:SMO	291
:CALC{1-4}:SMO:APER	292
:CONT:HAND:A	293
:CONT:HAND:B	293
:CONT:HAND:C	294
:CONT:HAND:C:MODE	295
:CONT:HAND:D	296
:CONT:HAND:D:MODE	297
:CONT:HAND:E	298
:CONT:HAND:F	299
:CONT:HAND:IND:STAT	300
:CONT:HAND:OUTP{1-2}	300
:CONT:HAND:RTR:STAT	301
:DISP:ANN:FREQ	302
:DISP:CCL	302
:DISP:CLOC	303

:DISP:COL{1-2}:BACK	304
:DISP:COL{1-2}:GRAT{1-2}	305
:DISP:COL{1-2}:LIM{1-2}	306
:DISP:COL{1-2}:RES	306
:DISP:COL{1-2}:TRAC{1-4}:DATA	307
:DISP:COL{1-2}:TRAC{1-4}:MEM	308
:DISP:ECHO	309
:DISP:ECHO:CLE	309
:DISP:ENAB	310
:DISP:FSIG	311
:DISP:IMAG	311
:DISP:MAX	312
:DISP:SKEY	312
:DISP:SPL	313
:DISP:TABL	314
:DISP:TABL:TYPE	315
:DISP:UPD	316
:DISP:WIND{1-4}:ACT	316
:DISP:WIND{1-4}:ANN:MARK:ALIG	317
:DISP:WIND{1-4}:ANN:MARK:SING	318
:DISP:WIND{1-4}:LAB	319
:DISP:WIND{1-4}:MAX	320
:DISP:WIND{1-4}:SPL	321
:DISP:WIND{1-4}:TITL	322
:DISP:WIND{1-4}:TITL:DATA	322
:DISP:WIND{1-4}:TRAC{1-4}:ANN:MARK:POS:X	323
:DISP:WIND{1-4}:TRAC{1-4}:ANN:MARK:POS:Y	324
:DISP:WIND{1-4}:TRAC{1-4}:ANN:YAX:MODE	325
:DISP:WIND{1-4}:TRAC{1-4}:MEM	326
:DISP:WIND{1-4}:TRAC{1-4}:STAT	327
:DISP:WIND{1-4}:TRAC{1-4}:Y:AUTO	327
:DISP:WIND{1-4}:TRAC{1-4}:Y:PDIV	328
:DISP:WIND{1-4}:TRAC{1-4}:Y:RLEV	329
:DISP:WIND{1-4}:TRAC{1-4}:Y:RPOS	330
:DISP:WIND{1-4}:TRAC{1-4}:Y:TRAC:FREQ	331
:DISP:WIND{1-4}:TRAC{1-4}:Y:TRAC:MODE	332
:DISP:WIND{1-4}:X:SPAC	333
:DISP:WIND{1-4}:Y:DIV	334
:FORM:BORD	335
:FORM:DATA	336
:HCOP	337
:HCOP:ABOR	337
:HCOP:IMAG	337
:INIT{1-4}	338
:INIT{1-4}:CONT	339
:MMEM:CAT?	340
:MMEM:COPY	341
:MMEM:DEL	342
:MMEM:LOAD	343

Contents

:MMEM:LOAD:CHAN	344
:MMEM:LOAD:CHAN:COEF	345
:MMEM:LOAD:LIM	346
:MMEM:LOAD:PROG	347
:MMEM:LOAD:RLIM	348
:MMEM:LOAD:SEGM	349
:MMEM:MDIR	350
:MMEM:STOR	351
:MMEM:STOR:CHAN	352
:MMEM:STOR:CHAN:CLE	352
:MMEM:STOR:CHAN:COEF	353
:MMEM:STOR:FDAT	354
:MMEM:STOR:IMAG	355
:MMEM:STOR:LIM	356
:MMEM:STOR:PROG	357
:MMEM:STOR:RLIM	358
:MMEM:STOR:SALL	359
:MMEM:STOR:SEGM	360
:MMEM:STOR:STYP	361
:MMEM:TRAN	362
:OUTP	363
:PROG:CAT?	363
:PROG:NAME	364
:PROG:STAT	365
:SENS:CORR:COLL:ECAL:PATH?	366
:SENS:CORR:IMP	367
:SENS{1-4}:AVER:CLE	368
:SENS{1-4}:AVER	368
:SENS{1-4}:AVER:COUN	369
:SENS{1-4}:BAND	370
:SENS{1-4}:BWID	371
:SENS{1-4}:CORR:CLE	371
:SENS{1-4}:CORR:COEF?	372
:SENS{1-4}:CORR:COLL:CKIT	373
:SENS{1-4}:CORR:COLL:CKIT:LAB	374
:SENS{1-4}:CORR:COLL:CKIT:ORD:LOAD	375
:SENS{1-4}:CORR:COLL:CKIT:ORD:OPEN	376
:SENS{1-4}:CORR:COLL:CKIT:ORD:SHOR	377
:SENS{1-4}:CORR:COLL:CKIT:ORD:THRU	378
:SENS{1-4}:CORR:COLL:CKIT:RES	378
:SENS{1-4}:CORR:COLL:CKIT:STAN{1-21}:ARB	379
:SENS{1-4}:CORR:COLL:CKIT:STAN{1-21}:C0	380
:SENS{1-4}:CORR:COLL:CKIT:STAN{1-21}:C1	381
:SENS{1-4}:CORR:COLL:CKIT:STAN{1-21}:C2	382
:SENS{1-4}:CORR:COLL:CKIT:STAN{1-21}:C3	383
:SENS{1-4}:CORR:COLL:CKIT:STAN{1-21}:DEL	384
:SENS{1-4}:CORR:COLL:CKIT:STAN{1-21}:L0	385
:SENS{1-4}:CORR:COLL:CKIT:STAN{1-21}:L1	386
:SENS{1-4}:CORR:COLL:CKIT:STAN{1-21}:L2	387

:SENS {1-4}:CORR:COLL:CKIT:STAN {1-21}:L3	388
:SENS {1-4}:CORR:COLL:CKIT:STAN {1-21}:LAB	389
:SENS {1-4}:CORR:COLL:CKIT:STAN {1-21}:LOSS	390
:SENS {1-4}:CORR:COLL:CKIT:STAN {1-21}:TYPE	391
:SENS {1-4}:CORR:COLL:CKIT:STAN {1-21}:Z0	392
:SENS {1-4}:CORR:COLL:ECAL:ERES	393
:SENS {1-4}:CORR:COLL:ECAL:ISOL	393
:SENS {1-4}:CORR:COLL:ECAL:SOLT1	395
:SENS {1-4}:CORR:COLL:ECAL:SOLT2	395
:SENS {1-4}:CORR:COLL:ECAL:THRU	396
:SENS {1-4}:CORR:COLL:ISOL	397
:SENS {1-4}:CORR:COLL:METH:ERES	397
:SENS {1-4}:CORR:COLL:LOAD	399
:SENS {1-4}:CORR:COLL:METH:OPEN	400
:SENS {1-4}:CORR:COLL:METH:SHOR	400
:SENS {1-4}:CORR:COLL:METH:SOLT1	401
:SENS {1-4}:CORR:COLL:METH:SOLT2	401
:SENS {1-4}:CORR:COLL:METH:THRU	402
:SENS {1-4}:CORR:COLL:METH:TYPE?	403
:SENS {1-4}:CORR:COLL:OPEN	404
:SENS {1-4}:CORR:COLL:SAVE	405
:SENS {1-4}:CORR:COLL:SHOR	405
:SENS {1-4}:CORR:COLL:THRU	406
:SENS {1-4}:CORR:EXT	407
:SENS {1-4}:CORR:EXT:PORT {1-2}	408
:SENS {1-4}:CORR:PROP	409
:SENS {1-4}:CORR:RVEL:COAX	409
:SENS {1-4}:CORR:STAT	410
:SENS {1-4}:CORR:TYPE {1-4}?	411
:SENS {1-4}:FREQ	412
:SENS {1-4}:FREQ:CENT	413
:SENS {1-4}:FREQ:DATA?	414
:SENS {1-4}:FREQ:SPAN	415
:SENS {1-4}:FREQ:STAR	416
:SENS {1-4}:FREQ:STOP	417
:SENS {1-4}:ROSC:SOUR?	418
:SENS {1-4}:SEGM:DATA	419
:SENS {1-4}:SEGM:SWE:POIN?	421
:SENS {1-4}:SEGM:SWE:TIME?	421
:SENS {1-4}:SWE:DEL	422
:SENS {1-4}:SWE:POIN	423
:SENS {1-4}:SWE:TIME	424
:SENS {1-4}:SWE:TIME:AUTO	425
:SENS {1-4}:SWE:TYPE	426
:SERV:CHAN:ACT?	426
:SERV:CHAN:COUN?	427
:SERV:CHAN {1-4}:TRAC:ACT?	427
:SERV:CHAN:TRAC:COUN?	427
:SERV:PORT:COUN?	428

Contents

:SOUR {1-4}:POW	429
:SOUR {1-4}:POW:ATT	430
:SOUR {1-4}:POW:CENT	431
:SOUR {1-4}:POW:PORT:COUP	432
:SOUR {1-4}:POW:PORT {1-2}	433
:SOUR {1-4}:POW:SLOP	434
:SOUR {1-4}:POW:SLOP:STAT	435
:SOUR {1-4}:POW:SPAN	436
:SOUR {1-4}:POW:STAR	437
:SOUR {1-4}:POW:STOP	438
:STAT:OPER?	439
:STAT:OPER:COND?	439
:STAT:OPER:ENAB	440
:STAT:OPER:NTR	441
:STAT:OPER:PTR	442
:STAT:PRES	443
:STAT:QUES?	443
:STAT:QUES:BLIM?	443
:STAT:QUES:BLIM:CHAN {1-4}?	444
:STAT:QUES:BLIM:CHAN {1-4}:COND?	444
:STAT:QUES:BLIM:CHAN {1-4}:ENAB	445
:STAT:QUES:BLIM:CHAN {1-4}:NTR	446
:STAT:QUES:BLIM:CHAN {1-4}:PTR	447
:STAT:QUES:BLIM:COND?	447
:STAT:QUES:BLIM:ENAB	448
:STAT:QUES:BLIM:NTR	449
:STAT:QUES:BLIM:PTR	450
:STAT:QUES:COND?	451
:STAT:QUES:ENAB	452
:STAT:QUES:LIM?	453
:STAT:QUES:LIM:CHAN {1-4}?	453
:STAT:QUES:LIM:CHAN {1-4}:COND?	453
:STAT:QUES:LIM:CHAN {1-4}:ENAB	454
:STAT:QUES:LIM:CHAN {1-4}:NTR	455
:STAT:QUES:LIM:CHAN {1-4}:PTR	456
:STAT:QUES:LIM:COND?	457
:STAT:QUES:LIM:ENAB	458
:STAT:QUES:LIM:NTR	459
:STAT:QUES:LIM:PTR	460
:STAT:QUES:NTR	461
:STAT:QUES:PTR	462
:STAT:QUES:RLIM?	463
:STAT:QUES:RLIM:CHAN {1-4}?	463
:STAT:QUES:RLIM:CHAN {1-4}:COND?	463
:STAT:QUES:RLIM:CHAN {1-4}:ENAB	464
:STAT:QUES:RLIM:CHAN {1-4}:NTR	465
:STAT:QUES:RLIM:CHAN {1-4}:PTR	466
:STAT:QUES:RLIM:COND?	466
:STAT:QUES:RLIM:ENAB	467

:STAT:QUES:RLIM:NTR	468
:STAT:QUES:RLIM:PTR	469
:SYST:BACK	470
:SYST:BEEP:COMP:IMM	471
:SYST:BEEP:COMP:STAT	471
:SYST:BEEP:WARN:IMM	472
:SYST:BEEP:WARN:STAT	472
:SYST:DATE	473
:SYST:ERR?	474
:SYST:KLOC:KBD	475
:SYST:KLOC:MOUS	476
:SYST:POFF	477
:SYST:PRES	477
:SYST:SEC:LEV	478
:SYST:SERV?	479
:SYST:TIME	480
:SYST:UPR	481
:TRIG	482
:TRIG:SING	482
:TRIG:SOUR	483
Command list	484
Command tree	484
A. Manual Changes	
Manual Changes	498
Change 2	499
Change 1	500
B. Status Reporting System	
General Status Register Model	504
Event Register	505
Enable Register	505
Status Byte Register	505
Condition Register and Transition Filter	506
Status Register Structure	507
Using the Status Reporting System	521
C. Error Messages	
Error Messages	524
A	524
B	524
C	524
D	525
E	525
F	526
G	527
H	527
I	527

Contents

L	528
M	528
N	528
O	529
P	529
Q	530
R	531
S	531
T	532
U	532
Warning Message	534

1 Making Effective Use of This Manual

This chapter describes the contents of this guide. Using this chapter with the table of contents helps you to retrieve description of a subject you wish to understand as well as to obtain an overview of this guide. Also see the latter part of this chapter for brief description of usage of this guide, focusing on searching commands.

Contents of This Manual

This is a programming guide with Agilent E5061A/E5062A.

This guide describes programming method mainly aiming at learning how to write a program that remotely controls the E5061A/E5062A using SCPI commands, focusing on sample usage with the HTBasic.

Controlling the E5061A/E5062A using the built-in VBA is not covered by this guide; it is described in *VBA Programmer's Guide*. For using the E5061A/E5062A VBA, see *VBA Programmer's Guide*.

Description in this guide assumes that the reader has learned manual operation of the E5061A/E5062A. Thus, this guide does not describe each feature of the E5061A/E5062A in detail. For detailed information on each feature, see *User's Guide*.

The chapter-by-chapter contents of this manual are as follows.

Chapter 1, "Making Effective Use of This Manual."

This chapter describes the contents of this guide. Using this chapter with the table of contents helps you to retrieve description of a subject you wish to understand as well as to obtain an overview of this guide. Also see the latter part of this chapter for brief description of usage of this guide, focusing on searching commands.

Chapter 2, "Overview of Remote Control."

This chapter provides an overview of the remote control system and the SCPI commands.

Chapter 3, "Setting Up the Analyzer."

This chapter describes how to configure measurement conditions and how to configure the way the instrument displays measurement results on the LCD.

Chapter 4, "Performing a Calibration."

This chapter describes how to obtain the calibration coefficients and perform error correction and how to define the calibration kit required to obtain the calibration coefficients.

Chapter 5, "Making a Measurement."

This chapter describes how to trigger the instrument to start a new measurement cycle and how to detect the end of a measurement cycle.

Chapter 6, "Analyzing Data."

This chapter describes how to use markers and analysis command.

Chapter 7, "Reading/Writing Measurement Data."

This chapter provides an overview of the Agilent E5061A/E5062A's internal data processing flow and describes how to read and write measurement results (internal data array).

Chapter 8, "Limit Test."

This chapter describes how to use the Limit Test feature to perform a limit test and determine the pass/fail status of the measured data.

Chapter 9, “Saving and Recalling (File Management).”

This chapter describes how to save and recall instrument status and measurement results onto/from the files. Here also covered is managing files.

Chapter 10, “Communication with External Instruments Using Handler I/O Port.”

This chapter provides necessary information for communicating with external instruments (for example, a handler in a production line) using the handler I/O port equipped with the Agilent E5061A/E5062A.

Chapter 11, “Working with Automatic Test Systems.”

This chapter describes useful features when the Agilent E5061A/E5062A is integrated with the automatic test system.

Chapter 12, “Sample Application Programs.”

This chapter introduces several sample programs for basic measurement, measurement with a system using the handler I/O, and controlling the instrument over LAN.

Chapter 13, “SCPI Command Reference.”

This chapter describes the SCPI command reference for the Agilent E5061A/E5062A. It describes the commands using their abbreviated format in alphabetical order. If you want to look up commands by softkeys, refer to the User’s Guide.

Appendix A, “Manual Changes.”

This appendix contains the information required to adapt this manual to earlier versions or configurations of the Agilent E5061A/E5062A than that indicated by the current printing date of this manual. The information in this manual applies directly to the E5061A/E5062A model that has the serial number prefix listed on the title page of this manual.

Appendix B, “Status Reporting System.”

This appendix describes the status reporting system of the Agilent E5061A/E5062A.

Appendix C, “Error Messages.”

The Agilent E5061A/E5062A provides error messages to indicate its operating status. This appendix describes the error messages of the E5061A/E5062A in order of error number.

How To Use This Manual

Chapters 3 to 9 provide task-based descriptions of SCPI commands that are useful for programming and explain how you can use them. These chapters contain explanations and sample program listings that you can use to develop your custom programs. For more information on individual commands, see Chapter 13, “SCPI Command Reference.”

Looking up SCPI commands

Chapter 13 “SCPI Command Reference” contains a complete reference of SCPI commands. You can look up a particular SCPI command in any of the following ways:

Lookup by Abbreviated Command Name

The command reference is organized alphabetically according to the abbreviated name used as the title for each command’s description.

Lookup by Full Command Name

You can use the index at the end of the manual to find full command names along with the page numbers where they appear.

NOTE

Some SCPI commands supported by the E5061A/E5062A have optional syntax elements. In the command reference conventions, these elements are enclosed between square brackets ([]) or printed in lowercase letters. See “Syntax” on page 192 for more information.

Using sample programs

This manual comes with a sample program disk, which contains the source files of the sample programs used in the manual. The disk is DOS-formatted and the files are saved in ASCII format.

Loading a sample program

To load a sample program into the HTBasic interpreter, use the GET command. For example, you can load setup.bas, one of the sample programs, by the following procedure:

In the HTBasic screen, type the following command and press the Return key.

```
GET "setup.bas"
```

Looking up a sample program

To look up the description of a sample program, see the listings under “Sample program” in the index.

Making Effective Use of This Manual
How To Use This Manual

2 Overview of Remote Control

This chapter provides an overview of the remote control system and the SCPI commands.

Types of remote control system

Depending on the system controller and the interface, you can configure 4 types of remote control system as shown in the table below.

System controller	Interface	Overview
External controller (external computer such as PC and workstation)	GPIB (talker/listener mode)	System to control the E5061A/E5062A and other devices connected via GPIB from the external controller. For more information, refer to “GPIB remote control system” on page 25.
	LAN	System to control the E5061A/E5062A and other devices connected via LAN from the external controller. For more information, refer to “LAN remote control system” on page 27.
E5061A/E5062A	—	System to control the E5061A/E5062A itself using built-in E5061A/E5062A VBA. For more information, refer to <i>VBA Programmers Guide</i> .
	GPIB (system controller mode)	System to control the E5061A/E5062A itself and external devices connected via GPIB using built-in E5061A/E5062A VBA. For more information, refer to <i>VBA Programmers Guide</i> .

GPIB remote control system

What is GPIB?

GPIB (General Purpose Interface Bus) is an interface standard for connecting computers and peripherals, which supports the following international standards: IEEE 488.1, IEC-625, IEEE 488.2, and JIS-C1901. The GPIB interface allows you to control the Agilent E5061A/E5062A from an external computer. The computer sends commands and instructions to the E5061A/E5062A and receives data sent from the E5061A/E5062A via GPIB.

System configuration

Use GPIB cables to connect between the E5061A/E5062A, the external controller (computer), and peripherals. Figure 2-1 shows the overview of the system configuration of the GPIB remote control system.

Figure 2-1 Configuration of the GPIB remote control system

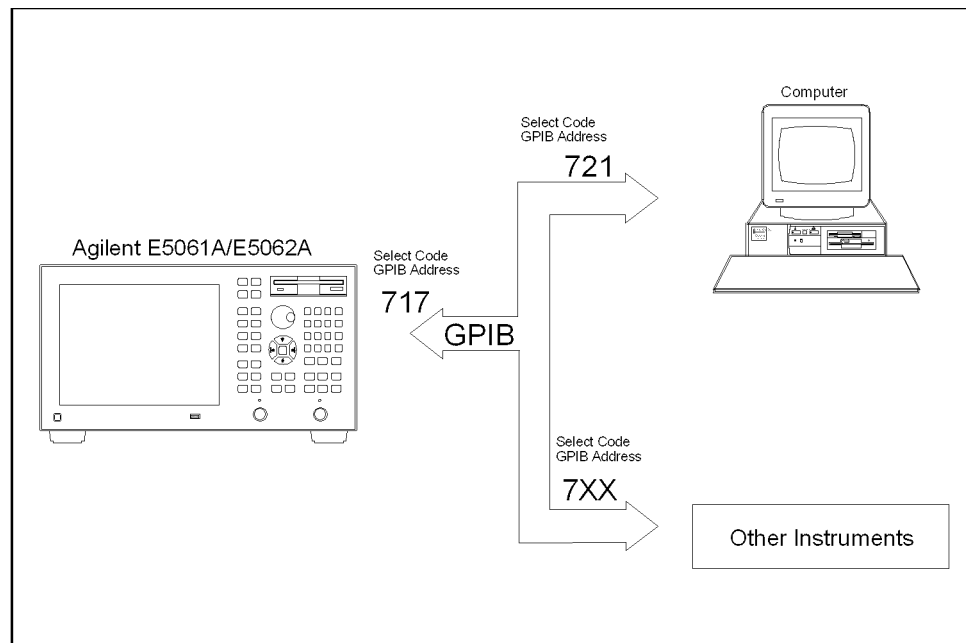

Overview of Remote Control GPIB remote control system

Required Equipment

1. E5061A/E5062A
2. External controller (computer)
Use a personal computer or workstation equipped with the GPIB interface. You need to install software to control this instrument via GPIB into the external controller (for example, HTBasic and Agilent VEE).
3. Other devices (other instruments and/or peripherals that serve your purpose)
4. GPIB cables for connecting the E5061A/E5062A, the external controller, and other devices

Scale of system you can construct

- You can connect up to 15 devices in a single GPIB system.
- The length of cables to connect between devices must be 4 m or less. The total length of connecting cables in a single GPIB system must be $2 \text{ m} \times$ the number of connected devices (including the controller) or less. You cannot construct the system in which the total cable length exceeds 20 m.
- The number of connectors connected to an individual device must be 4 or less. If you connect 5 or more connectors, excessive force is applied to the connector part, which may result in failure.
- You can choose the device connection topology from star, linear, and combined. Loop connection is not supported.

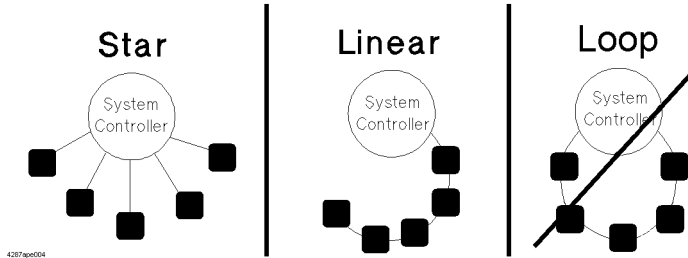

Device selector

The device selector is a unique value assigned to each device that is used by the controller to select the control target (to send/receive messages) among devices connected on the GPIB remote control system.

The device selector consists of a select code (usually, 7) and a GPIB address. For example, when the select code is 7 and the GPIB address is 17, the device selector is 717. The select code must be set for each system. The GPIB address must be set to a unique value for each device, which is used to identify devices on the same system. In the description and sample programs in this manual, it is assumed that the device selector is set to 717.

Setting the GPIB address of the E5061A/E5062A

[System] - GPIB Setup - Talker/Listener Address

LAN remote control system

The LAN (Local Area Network) remote control system provides two methods: controlling the E5061A/E5062A using the SICL-LAN server and controlling the E5061A/E5062A using the telnet server.

System configuration

Use a LAN cable to connect between the E5061A/E5062A and the external controller (computer). Figure 2-2 shows the overview of the system configuration of the LAN remote control system.

Figure 2-2

Configuration of the LAN remote control system

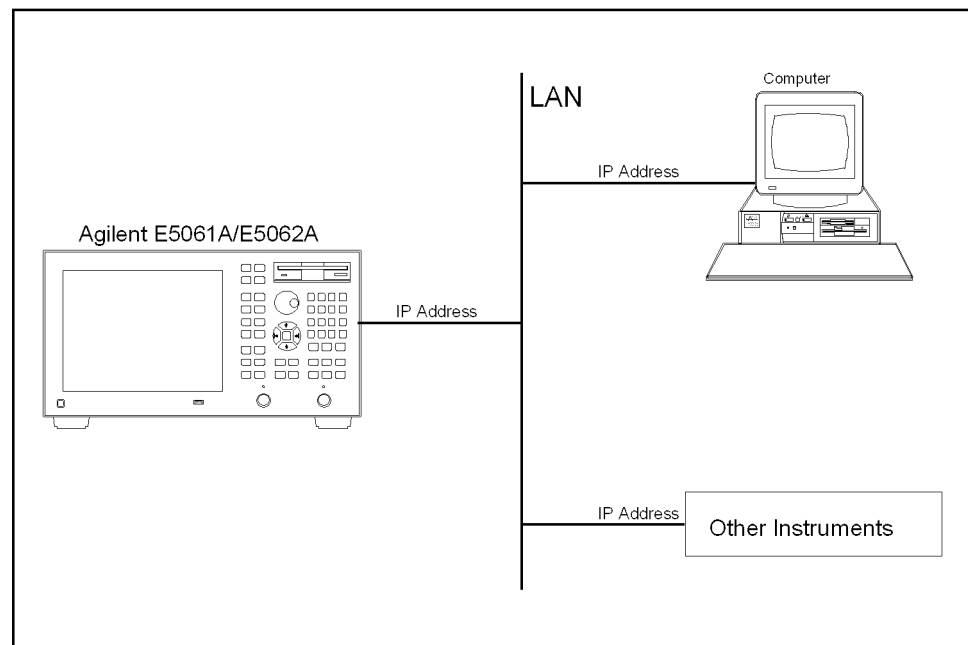

e5061ape003

Required Equipment

1. E5061A/E5062A
2. External controller (personal computer or workstation that can be connected to LAN and Agilent I/O Library is installed into)
3. Other devices (other instruments and/or peripherals that serve your purpose)
4. LAN cable for connecting the E5061A/E5062A with the external controller

Preparing the E5061A/E5062A

Before controlling the E5061A/E5062A via LAN, you need to configure the network function. For detailed information on the procedure, refer to *User's Guide*.

Control over SICL-LAN server

In the control system using the SICL-LAN server, communication between the external controller (client) and the E5061A/E5062A (server) is performed using the SICL-LAN protocol. Communication is performed using SICL (Standard Instrument Control Library). You can control the E5061A/E5062A by programming using SICL or VISA with the C language in the UNIX environment, or Visual C++, Visual Basic, or VEE in the Windows environment.

Preparing the E5061A/E5062A

To communicate with the external controller, follow these steps to turn on the SICL-LAN server of the E5061A/E5062A in advance.

Step 1. Turn on the SICL-LAN server of the E5061A/E5062A.

[System] - Misc Setup - Network Setup - SICL-LAN Server [ON]

Step 2. Set the GPIB address of the E5061A/E5062A for control with the SICL-LAN server. “XX” represents an address number.

[System] - Misc Setup - Network Setup - SICL-LAN Address [XX]

NOTE

You need to restart the E5061A/E5062A firmware after changing the on/off setting or address setting of the SICL-LAN server.

Preparing the external controller

In order to establish communication to the E5061A/E5062A using the TCP/IP protocol, you need to set the I/O interface of the external controller in advance. This section shows the setting procedure when using the external controller in the Windows environment.

NOTE

You need to install the Agilent I/O Libraries in advance.

Step 1. From the Start menu of your PC, click Program - Agilent I/O Libraries - I/O Config to open the Config setting screen.

Step 2. In the IO Config setting screen, select **TCPIP LAN Client (LAN Instruments)** and click the **Configure** button.

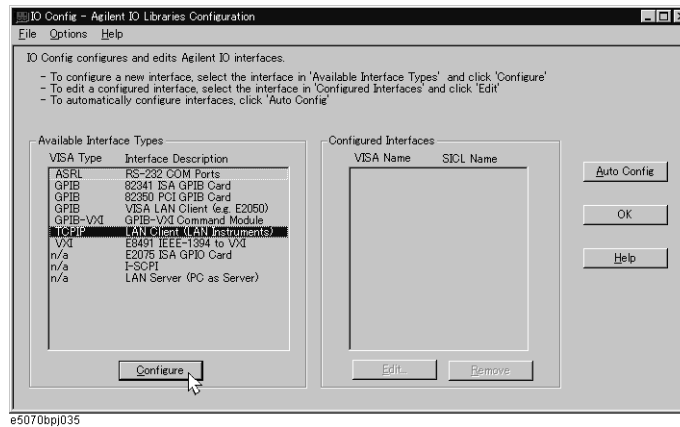

e5070bpj035

- Step 3.** In the LAN Client setting screen, leave the initial settings and click the **OK** button. You can change the settings as necessary. For detail, refer to the manual of the Agilent I/O Libraries.

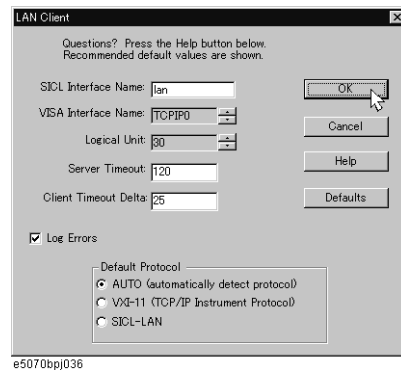

- Step 4.** In the IO Config setting screen, check that the LAN Client has been added and then click the **OK** button.

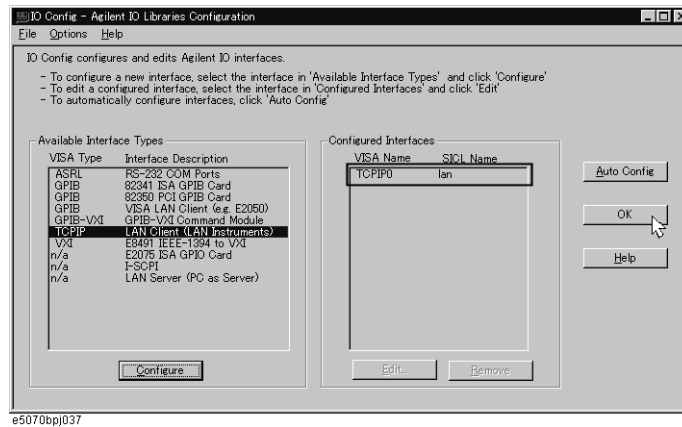

Control using C or Visual Basic

You can control the E5061A/E5062A by programming using SICL with the C language in the UNIX environment, or Visual C++ or Visual Basic in the Windows environment.

For more information on the control method, see a sample program using the VBA macro of Microsoft Excel described in “Controlling Using SICL-LAN Server” on page 174.

Control using Agilent VEE

Agilent VEE allows you to control the E5061A/E5062A via the I/O interface. The following example shows how to control the E5061A/E5062A that is set as follows: the address of the SICL-LAN server is 17 and the IP address is 1.10.100.50.

NOTE

When using Agilent VEE for PC, use Agilent VEE Pro 6 for Windows or later.

- Step 1.** On the Agilent EVE’s **I/O** menu, click **Instrument Manager...**

Overview of Remote Control LAN remote control system

Step 2. In the Instrument Manager setting screen, click **Add...**

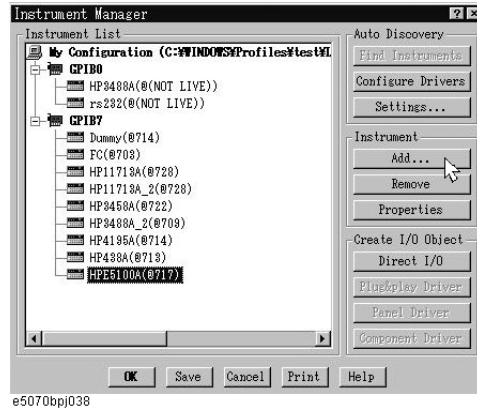

Step 3. The Instrument Properties setting screen appear. Make the settings as follows: Name (1 in the figure below): **SICL_LAN** (you can specify any name), Interface (2 in the figure below): **GPIB**, and Address (3 in the figure below): **917** (for the E5061A/E5062A, fixed to 9. 17 is the address of the SICL-LAN server). Then, click Gateway: **This host**. The Select or Enter Gateway setting screen appears. Enter the IP address or host name of the E5061A/E5062A (4 in the figure below).

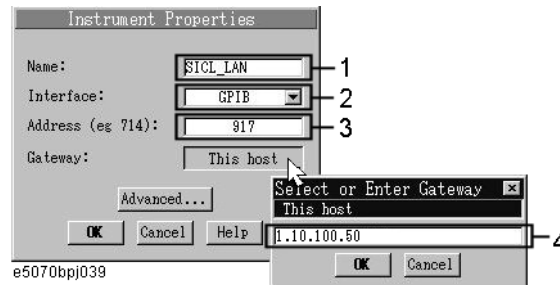
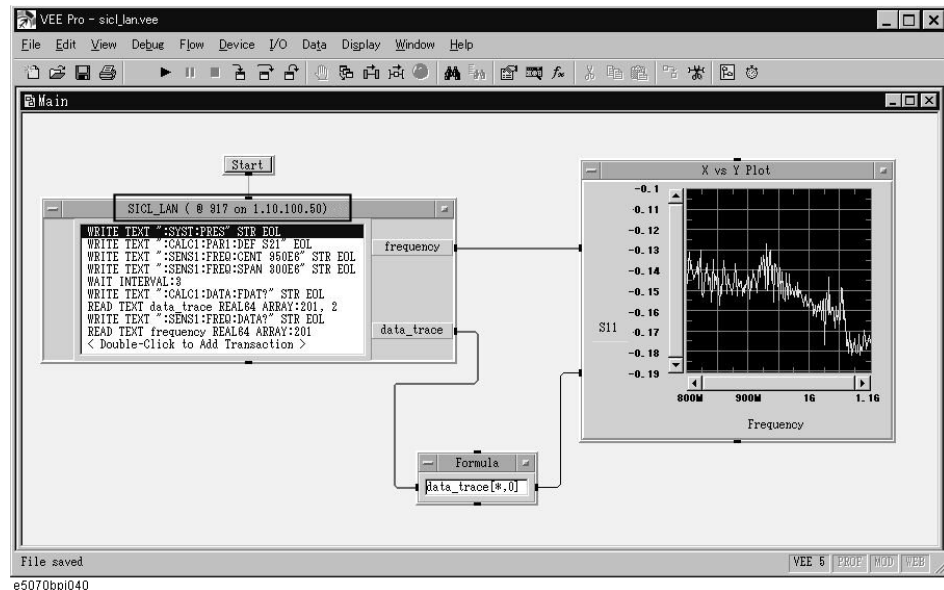

Figure 2-3 shows an example of control using the I/O interface that has been set in the above procedure.

Figure 2-3

Example of control using Agilent VEE



Control over telnet server

In the control system over telnet server, communications are performed through connection between the sockets provided by the processes of the external controller and the E5061A/E5062A to establish a network path between them.

A socket is an endpoint for network connection; port 23 and port 5025 are provided for the sockets for the E5061A/E5062A. Port 23 is provided for conversational control using telnet (user interface program for the TELNET protocol) and port 5025 for control from a program.

Preparing the E5061A/E5062A

To communicate with the external controller, follow these steps to turn on the telnet server of the E5061A/E5062A in advance.

[System] - Misc Setup - Network Setup - Telnet Server [ON]

Conversational control using telnet (using port 23)

You can use telnet to perform conversational control by sending SCPI commands to the E5061A/E5062A on a message-by-message basis. For telnet, the socket of port 23 is used for communications.

In this example, in order to show you the control procedure using telnet, you control the E5061A/E5062A (IP address: 1.10.100.50 and host name: e5061a) from the external controller in the Windows environment.

- Step 1.** Open the MS-DOS command prompt screen.
- Step 2.** At the MS-DOS prompt, type telnet 1.10.100.50 or telnet e5061a and press the return key.
- Step 3.** The telnet screen opens.
- Step 4.** Type a command and press the return key; it is sent to the E5061A/E5062A and executed. If you enter a command that queries some data, the query response is displayed below the line you have entered the command.

Figure 2-4 shows the screen after using the :SYST:PRES command on page 477 to reset, the :SENS{1-4}:FREQ:STAR command on page 416 and :SENS{1-4}:FREQ:STOP command on page 417 commands to set the sweep start value and stop value to 1 GHz and 2 GHz respectively, and checking the settings.

Figure 2-4

Example of control using telnet

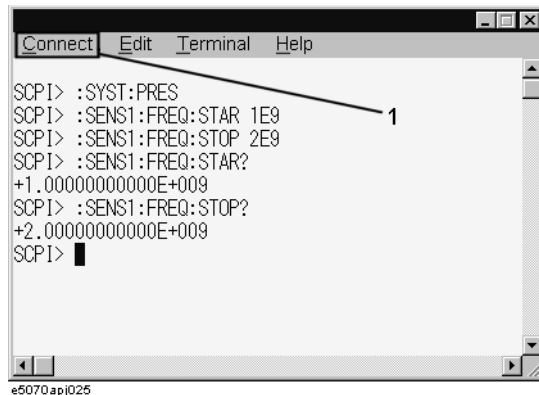

- Step 5.** Select Disconnect from the Connect menu in the telnet screen (1 in Figure 2-4) to break the connection to the E5061A/E5062A and select Exit from the Edit menu to exit the telnet. (In other environment such as the UNIX environment, press] while holding down the control key. The telnet prompt appears. At the telnet prompt, type quit and press the return key. The connection to the E5061A/E5062A breaks and telnet finishes.)

Control from a program (using port 5025)

When controlling the E5061A/E5062A from a program on the external controller, use the socket of port 5025 for connection.

NOTE

Some functions such as service requests that are available in the GPIB remote control system are not available in control over telnet server.

Control using C or Visual Basic

You can control the E5061A/E5062A by socket programming using the C language in the UNIX environment, or Visual C++ or Visual Basic in the Windows environment.

For socket programming, the library for network connection on the TCP/IP protocol is required. For the UNIX environment, BSD (Berkeley Software Distribution) Sockets API is available; for the Windows environment, WinSock (WinSock1.1 and WinSock2.0) created by porting BSD Sockets to Windows and expanding it is available.

For more information on the control method, see a sample program for control using WinSock described in “Controlling Using Telnet Server” on page 182.

Agilent Control using VEE

Agilent VEE allows you to control the E5061A/E5062A through the connection to the socket of port 5025 using To/From Socket. Figure 2-5 shows an example (when the IP address of the E5061A/E5062A is 1.10.100.50). Enter 5025 in the field to specify the port for connection (1 in Figure 2-5) and enter the IP address or host name of the E5061A/E5062A in the field to specify the host name (2 in Figure 2-5).

Figure 2-5

Example of control using Agilent VEE

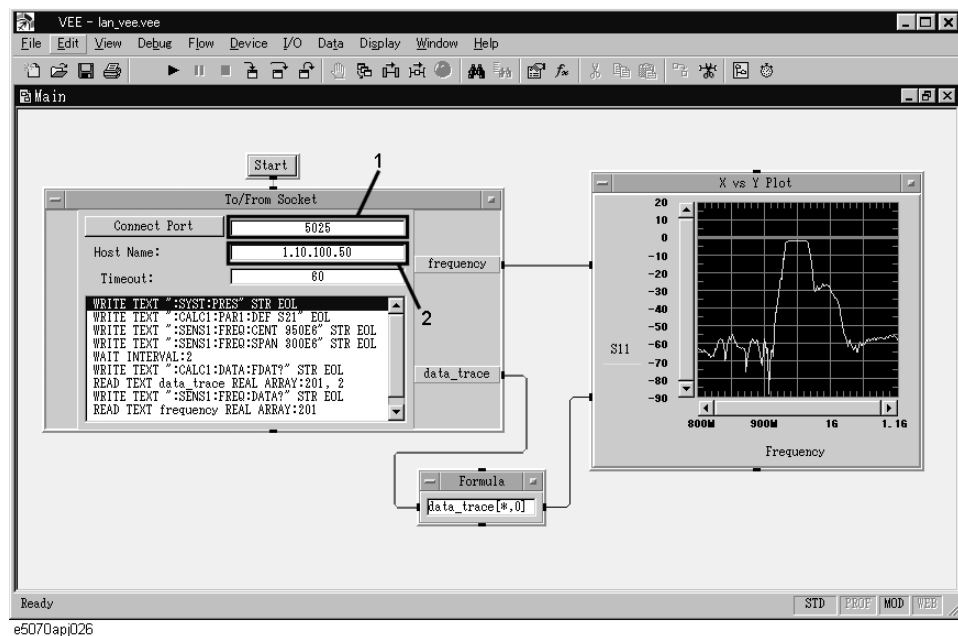

Sending SCPI command messages

Types and structure of commands

The SCPI commands available for the E5061A/E5062A are classified into 2 groups as follows.

E5061A/E5062A commands

Commands specific to the E5061A/E5062A. They cover all measurement functions that the E5061A/E5062A has and some general-purpose functions. The commands in this group are arranged in a hierarchical structure called the command tree (see “Command tree” on page 484). Each command consists of character strings (mnemonics) indicating each hierarchical level and colon (:) separators between hierarchical levels.

IEEE common commands

Commands to cover general-purpose functions defined in IEEE488.2 that are available commonly to instruments that support this standard. The commands in this group have an asterisk (*) at the beginning. For the commands in this group, there is no hierarchical structure.

Concepts of the command tree

The commands at the top of the command tree are called “root command” or simply “root.” To access lower level commands in the tree, you need to specify a specific path like a directory path in the DOS file system. After power-on or reset, the current path is set to the root. Special characters in messages change the path setting as described below.

- Message terminator A message terminator such as the
<new line> character sets the current path to the root.
- Colon (:) A colon between 2 command mnemonics lowers the level of the current path in the command tree. A colon used as the first character of a command specifies the command mnemonic that follows as the root-level command.
- Semicolon (;) A semicolon does not change the current path and separates 2 commands in the same message.

Figure 2-6 shows an example of how to use colons and semicolons to efficiently access commands in the command tree.

Figure 2-6

Using colons and semicolons

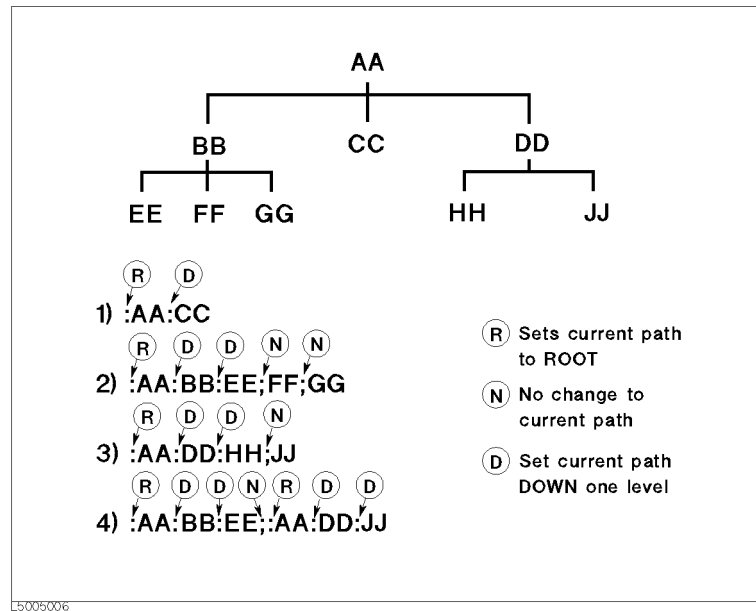

Grammar of messages

This section describes the grammar to send program messages via GPIB. Program messages are messages that the user sends to the instrument from the external controller to control the instrument. A program message consists of 1 or more commands and their necessary parameters.

Upper/lower case sensitivity

Upper/lower case insensitive.

Program message terminator

A program message must be terminated with one of the 3 program message terminators: <new line>, <^END>, or <new line><^END>. <^END> indicates that EOI on the GPIB interface becomes active at the instant when the immediately previous data byte is sent. For example, the OUTPUT command of HTBasic automatically sends the message terminator after the last data byte.

Parameters

A space (ASCII code: 32) is required between a command and its first parameter. When sending several parameters in a single command, separate each parameter with a comma (,).

Message including several commands

When sending 2 or more commands in a single message, separate each command with a semicolon (;). The following example shows how to send the *CLS command and the :STAT:PRES command in a single message using HTBasic.

```
OUTPUT 717; "*CLS; :STAT:PRES"
```

Remote mode

The E5061A/E5062A does not provide remote mode. Therefore, even if you send a GPIB command, it never enters into remote mode automatically. There is no local key to release remote mode.

If you need to prevent misoperation during remote control due to entry from the front panel or mouse, lock the input devices using the following commands.

- :SYST:KLOC:KBD command on page 475
- :SYST:KLOC:MOUS command on page 476

3

Setting Up the Analyzer

This chapter describes how to configure measurement conditions and how to configure the way the instrument displays measurement results on the LCD.

Selecting the Active Channel/Trace

You can configure the E5061A/E5062A using various commands. Some commands require you to specify, and deal only with, a particular channel or trace while other commands do not require you to do so.

Those commands that do not require you to specify a particular channel or trace apply to currently active channels and traces. Before issuing such a command, therefore, you must make the appropriate channels and traces active.

To make a channel active, use the following command:

- `:DISP:WIND{1-4}:ACT` on page 316

NOTE

Only the currently displayed channels can be an active channel. Therefore, you must display the desired channels using `:DISP:SPL` command on page 313 before you can make them active.

To make a trace active, use the following command:

- `:CALC{1-4}:PAR{1-4}:SEL` on page 284

NOTE

Only the currently displayed traces can be an active trace. Therefore, you must display the desired traces using `:CALC{1-4}:PAR:COUN` command on page 282 before you can make them active.

Configuring Measurement Conditions

Setting the Number of Traces

When you set the number of traces, that setting determines the upper limit trace number; for example, if the setting is 3, traces 1 through 3 will be displayed. To set the number of traces, use the following command:

- `:CALC{1-4}:PAR:COUN` on page 282

NOTE

Only the currently displayed traces can be an active trace. Therefore, you must set the number of traces appropriately before you can make them active.

Selecting Measurement Parameters

To select the measurement parameter (S parameter) for each trace, use the following command:

- `:CALC{1-4}:PAR{1-4}:DEF` on page 283

Setting the Sweep Condition (Stimulus)

How you can set the sweep condition depends on the sweep type. You can choose between the following four sweep types:

- Liner sweep
- Log sweep
- Segment sweep
- Power sweep

To select one of the above sweep types, use the following command:

- `:SENS{1-4}:SWE:TYPE` on page 426

Turning On/Off of Stimulus Signal Output

To turn on/off the stimulus signal output, use the following commands. For example, if the power output is automatically turned off due to the power trip feature, remove the cause of the overinput and turn on the stimulus signal output by executing the following command. You cannot perform measurement until you turn on the stimulus signal output.

- `:OUTP` on page 363

Configuring Linear Sweep Settings

To set the sweep range, use the following commands:

Start value	<code>:SENS{1-4}:FREQ:STAR</code> on page 416
Stop value	<code>:SENS{1-4}:FREQ:STOP</code> on page 417
Center value	<code>:SENS{1-4}:FREQ:CENT</code> on page 413

Setting Up the Analyzer

Configuring Measurement Conditions

Span value	:SENS{1-4}:FREQ:SPAN on page 415
------------	----------------------------------

To set the number of measurement points, use the following command:

- :SENS{1-4}:SWE:POIN on page 423

To set the measurement time, use the following commands:

Measurement time	:SENS{1-4}:SWE:TIME on page 424
Turning on/off auto setting	:SENS{1-4}:SWE:TIME:AUTO on page 425

To set the sweep delay time, use the following command:

- :SENS{1-4}:SWE:DEL on page 422

To set the IF bandwidth, use the one of the following commands (both provide the same function):

- :SENS{1-4}:BAND on page 370
- :SENS{1-4}:BWID on page 371

Setting Power Level

When the instrument is equipped with the power range expansion function (Option 250, 275, 1E1), you select the power range using the following command:

- :SOUR{1-4}:POW:ATT on page 430

To set the power level, use the following command:

- :SOUR{1-4}:POW on page 429

To select whether to output the same power level (the set value for port 1) or different power level for each port, use the following command:

- :SOUR{1-4}:POW:PORT:COUP on page 432
- :SOUR{1-4}:POW:PORT{1-2} on page 433

To set the correction of power level attenuation proportional to the frequency (power slope feature), use the following command:

- :SOUR{1-4}:POW:SLOP:STAT on page 435
- :SOUR{1-4}:POW:SLOP on page 434

Configuring Segment Sweep Settings

When you opt to use segment sweep, you can set all items (in the segment sweep table) using a single command:

- :SENS{1-4}:SEGM:DATA on page 419

Alternatively, you can configure the segment sweep settings based on the data contained in a CSV file by issuing the following command:

- :MMEM:LOAD:SEGM on page 349

Also, you can save the contents of the current segment sweep table to a file by issuing the following command:

- :MMEM:STOR:SEGM on page 360

For more information on how to save and load the segment sweep table, refer to “Saving and recalling the segment sweep table.”

Configuring Power Sweep Settings

To set the sweep range, use the following commands:

Start value	:SOUR{1-4}:POW:STAR on page 437
Stop value	:SOUR{1-4}:POW:STOP on page 438
Center value	:SOUR{1-4}:POW:CENT on page 431
Span value	:SOUR{1-4}:POW:SPAN on page 436

To set the fixed frequency (CW frequency), use the following command:

- :SENS{1-4}:FREQ on page 412

To set the number of points, the sweep time, the sweep delay time, and the IF bandwidth, use the same commands as for the linear/log sweep.

Configuring Averaging Settings

To configure the smoothing settings, use the following commands:

On/off	:SENS{1-4}:AVER on page 368
Averaging factor	:SENS{1-4}:AVER:COUN on page 369
Clear (Restart)	:SENS{1-4}:AVER:CLE on page 368

Setting the System Z0

NOTE

This function is available with the firmware version 3.01 or greater.

To set the system characteristic impedance (Z0), use the following command:

- :SENS:CORR:IMP on page 367

Configuring Display Settings

Setting the Layout of Windows and Graphs

You can split the E5061A/E5062A's LCD screen into multiple windows that display channel-specific result information, and can select the window layout from a number of variations. In addition, you can place on screen a segment sweep table or echo window (which you can use to display messages from your custom program).

Selecting the Window Layout (Channel Display Mode)

One window displays the results for a single channel. You cannot have a single window display the results from more than one channel. This means that setting the window layout determines the number of channels displayed on screen.

To select one of the 14 different window layouts shown in Figure 3-1, use the following command:

- `:DISP:SPL` on page 313

Selecting the Graph Layout (Trace Display Mode)

You can place a number of trace graphs in each window, and can select one of the pre-defined graph layouts. The number of graphs differ depending on your selected graph layout. If the number of graphs is equal to or larger than the number of traces (set by the `:CALC{1-4}:PAR:COUN` command on page 282 command), each graph always displays one trace. On the other hand, if the number of graphs is smaller than the number of traces, some of the graphs display two or more traces. Graph 1 is populated with trace 1, graph 2 with trace 2, and so on. Traces whose numbers exceed the last graph's number will populate graph 1, graph 2, and so on.

To select one of the 14 different graph layouts shown in Figure 3-1, use the following command:

- `:DISP:WIND{1-4}:SPL` on page 321

Maximizing a Window and Graphs

When you have multiple windows displayed, you can maximize the active channel window so that it covers the entire screen area. To maximize a window, use the following command:

- `:DISP:MAX` on page 312

Similarly, when you have multiple traces displayed, you can maximize the active trace so that it extends throughout the entire window. To maximize a trace, use the following command:

- `:DISP:WIND{1-4}:MAX` on page 320

Figure 3-1

Window/graph layouts and command parameters

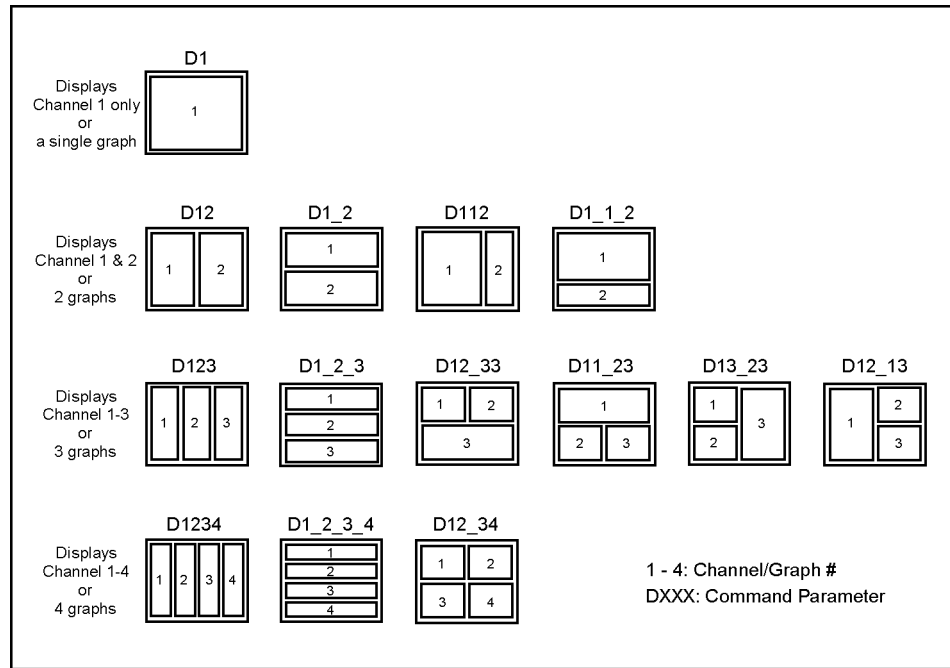

e5061ape001

Setting Up the Analyzer

Configuring Display Settings

Showing/Hiding a Table or Echo Window

You can have the following items displayed at the bottom of the LCD screen.

- Segment sweep table
- Limit table
- Marker list table
- Echo window (a window you can use to display messages from your custom program)

To show or hide each of the above items, use the following command:

- `:DISP:TABL` on page 314

You can have two or more of the above items displayed at a time. The screen displays only the item selected using the following command:

- `:DISP:TABL:TYPE` on page 315

Showing/Hiding Softkey Labels

You can show or hide the softkey labels placed alongside the right-hand edge of the LCD screen. To show or hide the softkey labels, use the following command:

- `:DISP:SKEY` on page 312

Configuring Trace Display Settings

Selecting Which Traces to Display

Each trace has two different representations: data and memory traces. You can show or hide the data and memory traces independently of each other. To show or hide the data or memory traces, use the following commands:

Data trace	:DISP:WIND{1-4}:TRAC{1-4}:STAT on page 327
Memory trace	:DISP:WIND{1-4}:TRAC{1-4}:MEM on page 326

To copy the data trace to the memory trace, use the following command:

- :CALC{1-4}:MATH:MEM on page 279

Configuring Cross-Trace Math Operations

You can perform math operations performed between the data and memory traces and have the results displayed as the data trace. To perform cross-trace math operations, use the following command:

- :CALC{1-4}:MATH:FUNC on page 279

Configuring Smoothing Settings

To turn on or off smoothing, use the following command:

- :CALC{1-4}:SMO on page 291

The smoothing aperture is expressed as a percentage with respect to the sweep range. To set the smoothing aperture, use the following command:

- :CALC{1-4}:SMO:APER on page 292

Selecting the Data Format

You can select the following data format:

- Rectangular display formats
 - Log magnitude format
 - Phase format
 - Group delay format
 - Linear magnitude format
 - SWR format
 - Real format
 - Imaginary format
 - Expanded phase format
 - Positive phase format
- Imaginary format
- Expanded phase format

To select the measurement parameter data format, use the following command:

- :CALC{1-4}:FORM on page 217

Setting Up the Analyzer

Configuring Display Settings

Configuring the Display Scale

Depending on the measurement parameter data format, you can configure the display scale in one of the following two ways:

Rectangular display formats:

When you are using one of rectangular display formats (Logarithmic magnitude/Phase/Group delay/Linear magnitude/SWR/Real/Imaginary/Expanded phase/Positive phase), you can configure the display scale by setting the following four items:

Number of divisions	:DISP:WIND{1-4}:Y:DIV on page 334
Scale per division	:DISP:WIND{1-4}:TRAC{1-4}:Y:PDIV on page 328
Reference graticule line	:DISP:WIND{1-4}:TRAC{1-4}:Y:RPOS on page 330
Reference graticule line value	:DISP:WIND{1-4}:TRAC{1-4}:Y:RLEV on page 329

NOTE

The number of divisions is a channel-wide setting (shared among all traces) while the remaining three settings are trace-specific.

You can show or hide graticule label (the label on the left-hand side of the graticule lines) by issuing the following command:

- :DISP:WIND{1-4}:LAB on page 319

Smith Chart/Polar formats:

When you are using one of Smith chart/Polar formats, you can only set the full scale value (the outermost circle's value) using the following command:

- :DISP:WIND{1-4}:TRAC{1-4}:Y:PDIV on page 328

Auto Scale

You can use Auto Scale to automatically set the display scale. This feature works by automatically adjusting the reference division line value and the scale value per division when you are using one of rectangular display formats; or the full scale value when you are using one of Smith chart/Polar formats.

To perform Auto Scale, use the following command:

- :DISP:WIND{1-4}:TRAC{1-4}:Y:AUTO on page 327

Printing a Message in the Echo Window

You can print a message in the echo window by issuing the following command:

- :DISP:ECHO on page 309

You can clear any message displayed in the echo window by issuing the following command:

- :DISP:ECHO:CLE on page 309

Turning On or Off Display Update

To turn on or off the update of the LCD screen, use the following command:

- :DISP:ENAB on page 310

Showing/Hiding Frequencies

To show or hide frequencies on the LCD screen, use the following command:

- :DISP:ANN:FREQ on page 302

Showing or Hiding the Title

To show or hide the title, use the following command:

- :DISP:WIND{1-4}:TITL on page 322

To define the title string that appears in the title display area, use the following command:

- :DISP:WIND{1-4}:TITL:DATA on page 322

Configuring Date/Time Display

To show or hide the current date and time on the left-hand side of the instrument status bar, use the following command:

- :DISP:CLOC on page 303

To set the date and time, use the following command:

- :SYST:DATE on page 473
- :SYST:TIME on page 480

Turning On or Off the LCD Backlight

To turn on or off the LCD backlight, use the following command (note that turning off the backlight makes the screen unreadable):

- :SYST:BACK on page 470

Setting display colors

Selecting display mode

You can select the display mode of the LCD display from 2 modes: normal display (background: black) or inverted display (background: white).

To select the display mode, use the following command:

- :DISP:IMAG on page 311

Setting display color for each item

To set the display colors, use the following commands:

Data trace	:DISP:COL{1-2}:TRAC{1-4}:DATA on page 307
Memory trace	:DISP:COL{1-2}:TRAC{1-4}:MEM on page 308
Graph	:DISP:COL{1-2}:GRAT{1-2} on page 305
Limit test	:DISP:COL{1-2}:LIM{1-2} on page 306
Background	:DISP:COL{1-2}:BACK on page 304

Resetting display colors to factory state

You can reset the display colors in normal display and inverted display to the preset factory state.

To reset the display colors, use the following command:

- :DISP:COL{1-2}:RES on page 306

Saving and Loading the Settings

You can save the settings for measurement conditions and screen display to a file along with other instrument settings, and can later load them from the file.

Once you have saved the measurement condition and screen display settings to a file, you can later load them whenever necessary; you can quickly modify the settings loaded from a file to create new settings without having to issue many commands.

To save the current settings to a file, use the following command:

- :MMEM:STOR on page 351

To load the settings from a file, use the following command:

- :MMEM:LOAD on page 343

For more information on how to save and load the settings, refer to “Saving and recalling instrument status.”

Sample Program

Example 3-1 is a sample program that demonstrates how to configure measurement conditions. You can find the source file of this program, named setup.htb, on the sample program disk.

The sample program puts the instrument into the preset state, configures it as shown in Table 3-1, and saves the settings to a file named “Ex_3_1.sta”.

Table 3-1 Target settings in Example 3-1

Item		Setting	
Window Layout		Channel 1 in the upper window (2/3 of the screen height) and channel 2 in the lower window (1/3 of the screen height)	
Channel 1	Sweep type	Segment	
	Sweep range	See Table 3-2.	
	Number of measurement points		
	IF bandwidth		
	Power		
	Number of traces	4	
	Graph Layout		Four graphs at upper left, upper right, lower left, and lower right.
	Trace 1	Measurement parameter	S11
		Data format	Smith chart (Lin)
		Full-scale value	2
	Trace 2	Measurement parameter	S21
		Data format	Log magnitude
		Reference division line number	9
		Reference division line value	2
	Trace 3	Scale per division	10 dBm
		Measurement parameter	S12
		Data format	Log magnitude
		Reference division line number	9
		Reference division line value	2
	Trace 4	Scale per division	10 dBm
Measurement parameter		S22	
Data format		Smith chart (Lin)	
	Full-scale value	2	

Table 3-1 Target settings in Example 3-1

Item		Setting	
Channel 2	Sweep type	Linear	
	Sweep range	Center value	1.9 GHz
		Span value	500 MHz
	Number of measurement points	101	
	IF bandwidth	30 kHz	
	Power	0 dBm	
	Number of traces	4	
	Graph Layout	Two graphs at left and right	
	Trace 1	Measurement parameter	S21
		Data format	Log magnitude
		Reference division line number	9
		Reference division line value	2
		Scale per division	10 dBm
	Trace 2	Measurement parameter	S22
		Data format	Smith chart (Lin)
Full-scale value		2	

Table 3-2 Segment table for channel 1

Segment Number	Start value	Stop value	Number of measurement points	IF bandwidth	Power
1	1.7 GHz	1.9 GHz	21	30 kHz	0 dBm
2	1.9 GHz	2 GHz	101	10 kHz	-10 dBm
3	2 GHz	2.2 GHz	21	30 kHz	0 dBm

Setting Up the Analyzer Sample Program

The program is described in detail below:

Line 70	Assigns a GPIB address to the I/O pass.
Line 90	Stores the number of channel 1's sweep segments into the Segm variable.
Lines 100 to 150	These lines store the start and stop values for channel 1's segments 1 through 3 into the Star1(*) and Stop1(*) variables, respectively.
Lines 160 to 170	These lines store channel 2's center and span values into the Star2 and Stop2 variables, respectively.
Lines 180 to 210	These lines store the number of points for channel 1's segments 1 through 3 into the Nop1(*) variable, and the number of measurement points for channel 2 into the Nop2 variable.
Lines 220 to 250	These lines store the IF bandwidth for channel 1's segments 1 through 3 into the If_bw1(*) variable, and the IF bandwidth for channel 2 into the If_bw2 variable.
Lines 260 to 290	These lines store the power for channel 1's segments 1 through 3 into the Pow1(*) variable, and the power for channel 2 into the Pow2 variable.
Lines 300 to 310	These lines store the number of channel 1 traces into the Num_of_tr1 variable, and the number of channel 2's traces into the Num_of_tr2 variable.
Lines 320 to 330	These lines store channel 1's graph layout into the Allocate1\$ variable, and channel 2's graph layout into the Allocate2\$ variable.
Lines 340 to 390	These lines store the measurement parameters for channel 1's traces 1 through 4 into the Para1\$(*) variable, and the measurement parameters for channel 2's traces 1 through 2 into the Para2\$(*) variable.
Lines 400 to 450	These lines store the data formats for channel 1's traces 1 through 4 into the Fmt1\$(*) variable, and the data formats for channel 2's traces 1 through 2 into the Fmt2\$(*) variable.
Lines 460 to 480	These lines store the reference division line numbers for channel 1's traces 2 through 3 into the Ref_pos1(*) variable, and the reference division line numbers for channel 2's trace 1 into the Ref_pos2(*) variable.
Lines 490 to 510	These lines store the reference division line values for channel 1's traces 2 through 3 into the Ref_lev1(*) variable, and the reference division line values for channel 2's trace 1 into the Ref_lev2(*) variable.
Lines 520 to 570	These lines store the data formats for channel 1's traces 1 through 4 into the Fmt1\$(*) variable, and the data formats for channel 2's traces 1 through 2 into the Fmt2\$(*) variable.
Line 580	Stores the name of the file into the File\$ variable.
Line 600	Puts the instrument into preset state.
Line 620	Places the window for channel 1 in the upper part of the LCD screen, and the window for channel 2 in the lower part.
Lines 630 to 640	These lines turn on Continuous Activation mode for channels 1 and 2.

Line 680	Sets channel 1's sweep type to "segment".
Lines 690 to 730	<p>These lines set up the segment table for channel 1.</p> <p>Line 600: Sends the command that sets up the segment table along with the parameter header ("5,0,1,1,0,0" causes the IF bandwidth and power to be set on a segment by segment basis; Segm represents the number of segments).</p> <p>Lines 700 to 730: Send the data for the start and stop values, number of points, IF bandwidth, and power (Star1, Stop1, Nop1, If_bw1, Pow1) on a segment by segment basis.</p>
Lines 750 to 760	For channel 1, these lines set the number of traces to Num_of_tr1 and the graph layout to Allocate1\$.
Lines 770 to 890	<p>For channel 1, the program iterates the following loop while incrementing i from 1 to Num_of_tr1 for each trace.</p> <p>Line 780: Sets the measurement parameter to Para1\$(i).</p> <p>Line 790: Makes trace(i) active.</p> <p>Line 800: Sets the data format to Fmt1\$(i).</p> <p>Line 830: If the data format is Smith chart or polar, this line sets the full-scale value to Scale1(i).</p> <p>Lines 850 to 870: If the data format is neither Smith chart nor polar, these lines set the reference division line number to Ref_pos1(i), the reference division line value to Ref_lev1(i), and the scale per division to Scale1(i).</p>
Line 930	Sets channel 2's sweep type to "linear".
Lines 940 to 980	For channel 2, these lines set the center value to Cent2, the span value to Span2, the number of measurement points to Nop2, the IF bandwidth to If_bw2, and the power to Pow2.
Lines 1000 to 1010	For channel 2, these lines set the number of traces to Num_of_tr2 and the graph layout to Allocate2\$.
Lines 1020 to 1140	<p>For channel 2, the program iterates the following loop while incrementing i from 1 to Num_of_tr2 for each trace.</p> <p>Line 1030: Sets the measurement parameter to Para2\$(i).</p> <p>Line 1040: Makes trace(i) active.</p> <p>Line 1050: Sets the data format to Fmt2\$(i).</p> <p>Line 1080: If the data format is Smith chart or polar, this line sets the full-scale value to Scale2(i).</p> <p>Lines 1100 to 1120: If the data format is neither Smith chart nor polar, these lines set the reference division line number to Ref_pos2(i), the reference division line value to Ref_lev2(i), and the scale per division to Scale2(i).</p>
Line 1160	Saves the settings of the E5061A/E5062A under the file name File\$.

Setting Up the Analyzer Sample Program

Example 3-1

Configuring Measurement Conditions (setup.hbt)

```

10   DIM Allocate1$(9),Allocate2$(9),File$(20)
20   DIM Para1$(1:4) [9],Para2$(1:2) [9],Fmt1$(1:4) [9],Fmt2$(1:2) [9]
30   REAL Star1(1:3),Stop1(1:3),Pow1(1:3),Cent2,Span2,Pow2
40   REAL Ref_rev1(1:4),Ref_rev2(1:2),Scale1(1:4),Scale2(1:2)
50   INTEGER Segm,Nop1(1:3),Nop2,Num_of_tr1,Num_of_tr2
60   INTEGER Ref_pos1(1:4),Ref_pos2(1:2),I
70   ASSIGN @Agte507x TO 717
80   !
90   Segm=3                ! Number of Segment Ch.1      : 3
100  Star1(1)=1.7E+9       ! Start Frequency Ch.1 Segm.1: 1.7 GHz
110  Star1(2)=1.9E+9       !                               Segm.2: 1.9 GHz
120  Star1(3)=2.E+9        !                               Segm.3: 2 GHz
130  Stop1(1)=1.9E+9       ! Stop Frequency Ch.1 Segm.1: 1.9 GHz
140  Stop1(2)=2.E+9        !                               Segm.2: 2 GHz
150  Stop1(3)=2.2E+9       !                               Segm.3: 2.2 GHz
160  Cent2=1.9E+9         ! Center Frequency Ch.2      : 1.9 GHz
170  Span2=5.00E+8        ! Span Ch.2                  : 500 MHz
180  Nop1(1)=21            ! Number Ch.1 Segm.1: 21
190  Nop1(2)=101          ! of Points Segm.2: 101
200  Nop1(3)=21           !                               Segm.3: 21
210  Nop2=101            !                               Ch.2      : 101
220  If_bw1(1)=5.0E+4     ! IF Bandwidth Ch.1 Segm.1: 50 kHz
230  If_bw1(2)=1.0E+4     !                               Segm.2: 10 kHz
240  If_bw1(3)=5.0E+4     !                               Segm.3: 50 kHz
250  If_bw2=7.0E+4        !                               Ch.2      : 70 kHz
260  Pow1(1)=0             ! Power Ch.1 Segm.1: 0 dBm
270  Pow1(2)=-10          !                               Segm.2: -10 dBm
280  Pow1(3)=0            !                               Segm.3: 0 dBm
290  Pow2=0               !                               Ch.2      : 0 dBm
300  Num_of_tr1=4         ! Number Ch.1                : 4
310  Num_of_tr2=2         ! of Traces Ch.2             : 2
320  Allocate1$="D12_34"  ! Allocate Traces Ch.1       : D12_34
330  Allocate2$="D12"     !                               Ch.2      : D12
340  Para1$(1)="S11"      ! Measurement Ch.1 Trace1: S11
350  Para1$(2)="S21"      ! Parameter Trace2: S21
360  Para1$(3)="S12"      !                               Trace3: S12
370  Para1$(4)="S22"      !                               Trace4: S22
380  Para2$(1)="S21"      !                               Ch.2 Trace1: S21
390  Para2$(2)="S22"      !                               Trace2: S22
400  Fmt1$(1)="SLIN"      ! Data Format Ch.1 Trace1:
Smith(Lin/Phase)
410  Fmt1$(2)="MLOG"      !                               Trace2: Log Mag
420  Fmt1$(3)="MLOG"      !                               Trace3: Log Mag
430  Fmt1$(4)="SLIN"      !                               Trace4: Smith(Lin/Phase)
440  Fmt2$(1)="MLOG"      !                               Ch.2 Trace1: Log Mag
450  Fmt2$(2)="SLIN"      !                               Trace2: Smith(Lin/Phase)
460  Ref_pos1(2)=9        ! Reference Ch.1 Trace2: 9
470  Ref_pos1(3)=9        ! Position Trace3: 9
480  Ref_pos2(1)=9        !                               Ch.2 Trace1: 9
490  Ref_lev1(2)=0        ! Reference Level Ch.1 Trace2: 0 dBm
500  Ref_lev1(3)=0        !                               Trace3: 0 dBm
510  Ref_lev2(1)=0        !                               Ch.2 Trace1: 0 dBm
520  Scale1(1)=2          ! Scale Ch.1 Trace1: 2
530  Scale1(2)=10         !                               Trace2: 10 dBm
540  Scale1(3)=10         !                               Trace3: 10 dBm

```

```

550 Scale1(4)=2          !                               Trace4: 2
560 Scale2(1)=10        !                               Ch.2 Trace1: 10 dBm
570 Scale2(2)=2         !                               Trace2: 2
580 File$="Ex_3_1.sta"  ! Save File Name              : Ex_3_1.sta
590 !
600 OUTPUT @Agte507x;":SYST:PRES"
610 !
620 OUTPUT @Agte507x;":DISP:SPL D1_1_2"
630 OUTPUT @Agte507x;":INIT1:CONT ON"
640 OUTPUT @Agte507x;":INIT2:CONT ON"
650 !
660 ! Channel 1
670 !
680 OUTPUT @Agte507x;":SENS1:SWE:TYPE SEGM"
690 OUTPUT @Agte507x;":SENS1:SEGM:DATA 5,0,1,1,0,0,";Segm;",";
700 FOR I=1 TO Segm-1
710     OUTPUT
@Agte507x;Star1(I);",";Stop1(I);",";Nop1(I);",";If_bw1(I);",";Pow1(I);",
";
720     NEXT I
730     OUTPUT
@Agte507x;Star1(Segm);",";Stop1(Segm);",";Nop1(Segm);",";If_bw1(Segm);",
";Pow(Segm)
740     !
750     OUTPUT @Agte507x;":CALC1:PAR:COUN ";Num_of_tr1
760     OUTPUT @Agte507x;":DISP:WIND1:SPL "&Allocate1$
770     FOR I=1 TO Num_of_tr1
780         OUTPUT @Agte507x;":CALC1:PAR"&VAL$(I)("&DEF "&Para1$(I)
790         OUTPUT @Agte507x;":CALC1:PAR"&VAL$(I)("&SEL"
800         OUTPUT @Agte507x;":CALC1:FORM "&Fmt1$(I)
810         SELECT Fmt1$(I)
820             CASE "SLIN","SLOG","SCOM","SMIT","SADM","PLIN","PLOG","POL"
830                 OUTPUT @Agte507x;":DISP:WIND1:TRAC"&VAL$(I)("&Y:PDIV
";Scale1(I)
840             CASE ELSE
850                 OUTPUT @Agte507x;":DISP:WIND1:TRAC"&VAL$(I)("&Y:RPOS
";Ref_pos1(I)
860                 OUTPUT @Agte507x;":DISP:WIND1:TRAC"&VAL$(I)("&Y:RLEV
";Ref_rev1(I)
870                 OUTPUT @Agte507x;":DISP:WIND1:TRAC"&VAL$(I)("&Y:PDIV
";Scale1(I)
880             END SELECT
890     NEXT I
900     !
910     ! Channel 2
920     !
921     PAUSE
930     OUTPUT @Agte507x;":SENS2:SWE:TYPE LIN"
940     OUTPUT @Agte507x;":SENS2:FREQ:CENT ";Cent2
950     OUTPUT @Agte507x;":SENS2:FREQ:SPAN ";Span2
960     OUTPUT @Agte507x;":SENS2:SWE:POIN ";Nop2
970     OUTPUT @Agte507x;":SENS2:BAND ";If_bw2
980     OUTPUT @Agte507x;":SOUR2:POW ";Pow2
990     !
1000    OUTPUT @Agte507x;":CALC2:PAR:COUN ";Num_of_tr2
1010    OUTPUT @Agte507x;":DISP:WIND2:SPL "&Allocate2$
1020    FOR I=1 TO Num_of_tr2
1030        OUTPUT @Agte507x;":CALC2:PAR"&VAL$(I)("&DEF "&Para2$(I)

```

Setting Up the Analyzer

Sample Program

```
1040     OUTPUT @Agte507x;":CALC2:PAR"&VAL$(I) &" :SEL"
1050     OUTPUT @Agte507x;":CALC2:FORM "&Fmt2$(I)
1060     SELECT Fmt2$(I)
1070         CASE "SLIN","SLOG","SCOM","SMIT","SADM","PLIN","PLOG","POL"
1080             OUTPUT @Agte507x;":DISP:WIND2:TRAC"&VAL$(I) &" :Y:PDIV
";Scale2(I)
1090         CASE ELSE
1100             OUTPUT @Agte507x;":DISP:WIND2:TRAC"&VAL$(I) &" :Y:RPOS
";Ref_pos2(I)
1110             OUTPUT @Agte507x;":DISP:WIND2:TRAC"&VAL$(I) &" :Y:RLEV
";Ref_rev2(I)
1120             OUTPUT @Agte507x;":DISP:WIND2:TRAC"&VAL$(I) &" :Y:PDIV
";Scale2(I)
1130         END SELECT
1140     NEXT I
1150     !
1160     OUTPUT @Agte507x;":MMEM:STOR ""&File$&""
1170     END
```

4

Performing a Calibration

This chapter describes how to obtain the calibration coefficients and perform error correction and how to define the calibration kit required to obtain the calibration coefficients.

Calibration

You need to execute calibration to eliminate error elements related to measurement and perform accurate measurement.

Performing a Calibration (Obtaining the Calibration Coefficients)

Selecting a Calibration Kit

To select a calibration kit, use the following command:

- `:SENS{1-4}:CORR:COLL:CKIT` on page 373

Selecting a Calibration Type

The calibration coefficients are calculated based on the selected calibration type. Before you can calculate the calibration coefficients, therefore, you must select the appropriate calibration type using the following command.

Calibration type		Command
Response	OPEN	<code>:SENS{1-4}:CORR:COLL:METH:OPEN</code> on page 400
	SHORT	<code>:SENS{1-4}:CORR:COLL:METH:SHOR</code> on page 400
	THRU	<code>:SENS{1-4}:CORR:COLL:METH:THRU</code> on page 402
Enhanced Response		<code>:SENS{1-4}:CORR:COLL:METH:ERES</code> on page 397
Full 1-Port		<code>:SENS{1-4}:CORR:COLL:METH:SOLT1</code> on page 401
Full 2-Port		<code>:SENS{1-4}:CORR:COLL:METH:SOLT2</code> on page 401

To check the currently selected calibration type, use the following command:

- `:SENS{1-4}:CORR:COLL:METH:TYPE?` on page 403

Measuring the Calibration Data

To measure the calibration data, use the following command:

Calibration data items	Command
OPEN	<code>:SENS{1-4}:CORR:COLL:OPEN</code> on page 404
SHORT	<code>:SENS{1-4}:CORR:COLL:SHOR</code> on page 405
LOAD	<code>:SENS{1-4}:CORR:COLL:LOAD</code> on page 399
THRU	<code>:SENS{1-4}:CORR:COLL:THRU</code> on page 406
Isolation	<code>:SENS{1-4}:CORR:COLL:ISOL</code> on page 397

NOTE

You cannot run more than one of the commands listed above at a time; if you issue another command before the currently running command completes successfully, the current command will be aborted. When you write a program that issues multiple calibration commands in series, therefore, you should use the `*OPC?` command on page 196 command or some other means to ensure that no command is executed before the

preceding command completes.

As shown in Table 4-1, the data required to calculate the calibration coefficients differs depending on the selected calibration type.

Table 4-1 Calibration Types and Required Data

Calibration type Selected ports are enclosed in parentheses.		Data				
		OPEN	SHORT	LOAD	THRU	Isolation
Response	OPEN (a)	a	Not required	[a]	Not required	Not required
	SHORT (a)	Not required	a	[a]	Not required	Not required
	THRU (a-b)	Not required	Not required	Not required	a-b	[a-b]
Enhanced Response (a-b)		b	b	b	a-b	[a-b]
Full 1-Port (a)		a	a	a	Not required	Not required
Full 2-Port (a-b)		a, b	a, b	a, b	a-b, b-a	[a-b], [b-a]

In the data section in the table, the letter m (for example, 1, a) represents the measurement data at port m; m-n (for example, 1-2, a-b) represents the measurement data between response port m and stimulus port n. You can omit data enclosed in brackets.

Performing a Calibration Calibration

Calculating the Calibration Coefficients

To calculate the calibration coefficients, use the following command:

Calibration type	Command
All calibration types	:SENS{1-4}:CORR:COLL:SAVE on page 405

Before issuing the above command, you must measure all the required calibration data items according to your selected calibration types (see Table 4-1).

Calculating the calibration coefficients clears all calibration data regardless it is used for the calculation. The calibration type selection is also cleared, which results in the state when no calibration type is selected.

Turning On or Off Error Correction

To turn on or off Error Correction, use the following command:

- :SENS{1-4}:CORR:STAT on page 410

Also, once you have calculated the calibration coefficient using the **:SENS{1-4}:CORR:COLL:SAVE** command, Error Correction is automatically turned on.

Using ECal

An ECal (Electronic Calibration) module allows you to perform full 1/2-port calibration and response (THRU) calibration without having to replacing the standard device.

ECal works by using the calibration kit data contained in the ECal module, instead of the calibration kit data selected on the part of the E5061A/E5062A. This means that you do not have to define or select a calibration kit when using ECal.

NOTE When two or more ECal modules are connected through the USB port, the system uses the calibration kit data contained in the first ECal module.

To perform ECal, use the following command:

Calibration type	Command
Full 1-Port Calibration	:SENS{1-4}:CORR:COLL:ECAL:SOLT1 on page 395
Full 2-Port Calibration	:SENS{1-4}:CORR:COLL:ECAL:SOLT2 on page 395
Enhanced Response Calibration	:SENS{1-4}:CORR:COLL:ECAL:ERES on page 393
Response Calibration (THRU)	:SENS{1-4}:CORR:COLL:ECAL:THRU on page 396

Simply issuing one of the above commands completes all the tasks necessary for error correction, including measuring the calibration data, calculating the calibration coefficients, and running on the Error Correction feature.

You can control whether to perform isolation measurement during ECal. To turn on or off isolation measurement, use the following command:

- :SENS{1-4}:CORR:COLL:ECAL:ISOL on page 393

NOTE If the ECal module does not support isolation measurement, the system never performs isolation measurement.

Checking the Applied Calibration Type

When you turn on Error Correction, you can check the calibration type actually applied to each trace. To check the calibration type, use the following command:

- :SENS{1-4}:CORR:TYPE{1-4}? on page 411

NOTE The above command reads out the same parameter (SOLT3) for both the full 3 port and the simplified full 3-port and therefore they cannot be discriminated. For the same reason, the full 4 port and the simplified full 4 port cannot be discriminated.

Defining Calibration Kits

Selecting a Calibration Kit

To select a calibration kit, use the following command:

- :SENS{1-4}:CORR:COLL:CKIT on page 373

Setting the Calibration Kit Name

To set the name of a calibration kit, use the following command:

- :SENS{1-4}:CORR:COLL:CKIT:LAB on page 374

Standard Definitions

Selecting a Standard Type To select a standard type, use the following command:

- :SENS{1-4}:CORR:COLL:CKIT:STAN{1-21}:TYPE on page 391

Setting the Standard Name To set the standard name, use the following command:

- :SENS{1-4}:CORR:COLL:CKIT:STAN{1-21}:LAB on page 389

Setting the Standard Value To set the standard value, use the following command:

Item	Command
C0	:SENS{1-4}:CORR:COLL:CKIT:STAN{1-21}:C0 on page 380
C1	:SENS{1-4}:CORR:COLL:CKIT:STAN{1-21}:C1 on page 381
C2	:SENS{1-4}:CORR:COLL:CKIT:STAN{1-21}:C2 on page 382
C3	:SENS{1-4}:CORR:COLL:CKIT:STAN{1-21}:C3 on page 383
L0	:SENS{1-4}:CORR:COLL:CKIT:STAN{1-21}:L0 on page 385
L1	:SENS{1-4}:CORR:COLL:CKIT:STAN{1-21}:L1 on page 386
L2	:SENS{1-4}:CORR:COLL:CKIT:STAN{1-21}:L2 on page 387
L3	:SENS{1-4}:CORR:COLL:CKIT:STAN{1-21}:L3 on page 388
Offset Delay	:SENS{1-4}:CORR:COLL:CKIT:STAN{1-21}:DEL on page 384
Offset Loss	:SENS{1-4}:CORR:COLL:CKIT:STAN{1-21}:LOSS on page 390
Offset Z0	:SENS{1-4}:CORR:COLL:CKIT:STAN{1-21}:Z0 on page 392
Arbitrary Impedance	:SENS{1-4}:CORR:COLL:CKIT:STAN{1-21}:ARB on page 379

As shown in Table 4-2, you need to set different items depending on the standard type.

Table 4-2 Settings Specific to Each Standard Type

Standard Types	C0 to C3	L0 to L3	Offset Delay	Offset Loss	Offset Z0	Arbitrary Impedance
OPEN	√		√	√	√	
SHORT		√	√	√	√	
LOAD			√	√	√	
THRU			√	√	√	
Arbitrary Impedance			√	√	√	√

You need to set the items identified by √ marks in the table above.

Defining a Standard Class Assignment

To select the standard to be applied to the OPEN measurement for each port, use the following command:

- :SENS{1-4}:CORR:COLL:CKIT:ORD:OPEN on page 376

To select the standard to be applied to the SHORT measurement for each port, use the following command:

- :SENS{1-4}:CORR:COLL:CKIT:ORD:SHOR on page 377

To select the standard to be applied to the LOAD measurement for each port, use the following command:

- :SENS{1-4}:CORR:COLL:CKIT:ORD:LOAD on page 375

To select the standard to be applied to the THRU measurement between each pair of ports, use the following command:

- :SENS{1-4}:CORR:COLL:CKIT:ORD:THRU on page 378

Saving and Loading Calibration Coefficients

You can save calibration coefficients to a file along with other instrument settings, and can later load them from the file.

NOTE

You cannot save, load, read, or write calibration coefficients independently of the other instrument settings.

By default, the system does not save calibration coefficients when it saves instrument settings. To save calibration coefficients, therefore, you must explicitly configure the system to save calibration coefficients by issuing the following command:

- :MMEM:STOR:STYP on page 361

To save calibration coefficients to a file, use the following command:

- :MMEM:STOR on page 351

To load calibration coefficients from a file, use the following command:

- :MMEM:LOAD on page 343

For more information on how to save and load calibration coefficients, refer to “Saving and recalling instrument status.”

Sample Program

Calibration

Example 4-1 shows a sample program that demonstrates how to calibrate the instrument. You can find the source file of this program, named `cal.htb`, on the sample program disk.

The sample program performs calibration with the specified calibration type, and saves the results to a file named “`Ex_4_1.sta`.”

The program is described in detail below:

- Line 40 Assigns a GPIB address to the I/O pass.
- Line 50 Stores the name of the file (`Ex_4_1.sta`) into the `File$` variable.
- Line 60 Stores the channel number (1) into the `Ch$` variable.
- Line 80 Calls a subprogram named `Select_cal_kit` to select the calibration kit.
- Line 110 Allows the user to return to the entry start line and re-enter the data if an error (such as an invalid entry) occurs while selecting the calibration type number.
- Lines 130 to 210 These lines display the list of supported calibration types, and prompts the user to choose one of the items by typing in the appropriate number.
- Line 220 Converts the entered value into an integer and stores it into the `Cal_type` variable.
- Line 230 Returns to the entry start line if an invalid value is contained in `Cal_type`.
- Lines 260 to 420 These lines call a subprogram named `Select_port` to select the appropriate port based on the value of `Cal_type`, and then perform calibration.
 - Lines 280 to 290: If `Cal_type = 1`, the program calls a subprogram named `Cal_resp` to perform response calibration (OPEN) after selecting the port.
 - Lines 310 to 320: If `Cal_type = 2`, the program calls the subprogram `Cal_resp` to perform response calibration (SHORT) after selecting the port.
 - Lines 340 to 350: If `Cal_type = 3`, the program calls a subprogram named `Cal_resp_thru` to perform response calibration (THRU) after selecting the port.
 - Lines 370 to 380: If `Cal_type = 4`, the program calls a subprogram named `Cal_solt` to perform full 1-port calibration after selecting the port.
 - Lines 400 to 410: If `Cal_type = 5`, the program calls the subprogram `Cal_solt` to perform full 2-port calibration after selecting the port.
- Lines 440 to 450 These lines configure the system to save calibration coefficients along

Performing a Calibration

Sample Program

with instrument settings, and then save the instrument settings under the file name contained in the File\$ variable.

The Select_cal_kit subprogram in lines 500 to 740, which selects the calibration kit, is described below.

- Lines 550 to 590 These lines retrieve the names of all the calibration kits and stores them into the Cal_kit_lbl\$(*) variable.
- Line 600 Allows the user to return to the entry start line and re-enter the data if an error (such as an invalid entry) occurs while entering the number that identifies the calibration kit.
- Lines 620 to 680 Displays the list of supported calibration kits, and prompts the user to choose one of the items by typing in the appropriate number.
- Line 690 Converts the entered value into an integer and stores it into the Cal_kit variable.
- Line 700 Returns to the entry start line if an invalid value is contained in Cal_kit.
- Line 730 Selects the calibration kit that matches the number contained in the Cal_kit variable.

The Select_port subprogram in lines 780 to 1010, which allows the user to select a port, is described below.

- Lines 830 to 840 If the value of Num_of_ports is 2 (2-port), the subprogram determines the port numbers (1, 2) without prompting the user to enter port numbers, and then store the port numbers into the Port(*) variable.
- Lines 860 to 990 If the value of Num_of_ports is not 2, the subprogram prompts the user to select as many ports as Num_of_ports.

Line 870: Allows the user to return to the entry start line and re-enter the data if an error (such as an invalid entry) occurs while entering the port number.

Lines 890 to 910: These lines print the index of the current port and prompt the user to enter the port number.

Lines 920: Converts the entered value into an integer and stores it into the Port(*) variable.

Lines 930 to 960: Return to the entry start line if the port number is beyond the range of 1 to 2 or conflicts with an already selected number.

The Cal_resp subprogram in lines 1050 to 1170, which performs response calibration (OPEN/SHORT), is described below.

- Line 1080 Displays the calibration type.
- Line 1090 Configures the instrument to perform response calibration (Type\$) on the port identified by the Port variable.
- Lines 1100 to 1110 These lines prompt the user to connect a Type\$ to port Port, and wait for a press of the [Enter] key after the connection.
- Lines 1120 to 1140 These lines execute the calibration data measurement command identified by Type\$ on port Port, and wait until the measurement completes successfully.
- Line 1150 Calculates the calibration coefficients and turns on error correction.
- Line 1160 Displays a closing message.

The Cal_resp_thru subprogram in lines 1210 to 1330, which performs response calibration (THRU), is described below.

- Line 1240 Displays the calibration type.
- Line 1250 Configures the instrument to perform response calibration (THRU) on response port Port 1 and stimulus port Port 2.
- Lines 1260 to 1270 These lines prompt the user to connect a THRU standard between the ports identified by Port1 and Port2, and wait for a press of the [Enter] key after the connection.
- Lines 1280 to 1300 These lines execute the THRU calibration data measurement command on response port Port1 and stimulus port 2, and wait until the measurement completes successfully.
- Line 1310 Calculates the calibration coefficients and turns on error correction.
- Line 1320 Displays a closing message.

Performing a Calibration

Sample Program

The Cal_solt subprogram in lines 1370 to 1900, which performs full n-port calibration, is described below.

- Line 1410 Displays the calibration type.
- Lines 1450 to 1490 These lines configure the instrument to perform full Num_of_ports port calibration on the ports identified by Port(1) through Port(Num_of_ports).
- Lines 1630 to 1690 These lines make up a loop that iterates while incrementing i from 1 to Num_of_ports.
- Lines 1540 to 1550: Prompt the user to connect an OPEN standard to port Port(i), and wait for a press of the [Enter] key after the connection.
- Lines 1560 to 1580: Execute the OPEN calibration data measurement command on port Port(i), and wait until the measurement completes successfully.
- Lines 1590 to 1600: Prompt the user to connect a SHORT standard to port Port(i), and wait for a press of the [Enter] key after the connection.
- Lines 1610 to 1630: Execute the SHORT calibration data measurement command on port Port(i), and wait until the measurement completes successfully.
- Lines 1640 to 1650: Prompt the user to connect a LOAD standard to port Port(i), and wait for a press of the [Enter] key after the connection.
- Lines 1660 to 1680: Execute the LOAD calibration data measurement command on port Port(i), and wait until the measurement completes successfully.
- Lines 1730 to 1840 These lines make up a loop that iterates while incrementing i from 1 to Num_of_ports-1 and j from i+1 to Num_of_ports.
- Lines 1750 to 1760: Prompt the user to connect a THRU standard between port Port(i) and port Port(j), and wait for a press of the [Enter] key after the connection.
- Lines 1770 to 1790: Execute the THRU calibration data measurement command on response port Port(i) and stimulus port Port(j), and wait until the measurement completes successfully.
- Lines 1800 to 1820: Execute the THRU calibration data measurement command on response port Port(j) and stimulus port Port(i), and wait until the measurement completes successfully.
- Line 1880 Calculates the calibration coefficients and turns on error correction.
- Line 1890 Displays a closing message.

Example 4-1

Calibration (cal.htb)

```

10     DIM File$[20],Ch$[9],Inp_char$[9]
20     INTEGER Cal_kit,Cal_type,Port(1:2)
30     !
40     ASSIGN @Agte507x TO 717
50     File$="Ex_4_1.sta"
60     Ch$="1"
70     !
80     Select_cal_kit(@Agte507x,Ch$)
90     !
100    CLEAR SCREEN
110    ON ERROR GOTO Type_select
120  Type_select: !
130    PRINT "## Calibration Type Selection ##"
140    PRINT " 1: Response (Open)"
150    PRINT " 2: Response (Short)"
160    PRINT " 3: Response (Thru)"
170    PRINT " 4: Full 1 Port"
180    PRINT " 5: Full 2 Port"
190    PRINT ""
200    PRINT "Input 1 to 5"
210    INPUT "Input number? (1 to 5)",Inp_char$
220    Cal_type=IVAL(Inp_char$,10)
230    IF Cal_type<1 OR Cal_type>5 THEN Type_select
240    OFF ERROR
250    !
260    SELECT Cal_type
270      CASE 1
280        Select_port(1,Port(*))
290        Cal_resp(@Agte507x,Ch$,"OPEN",Port(1))
300      CASE 2
310        Select_port(1,Port(*))
320        Cal_resp(@Agte507x,Ch$,"SHOR",Port(1))
330      CASE 3
340        Select_port(2,Port(*))
350        Cal_resp_thru(@Agte507x,Ch$,Port(1),Port(2))
360      CASE 4
370        Select_port(1,Port(*))
380        Cal_solt(@Agte507x,Ch$,1,Port(*))
390      CASE 5
400        Select_port(2,Port(*))
410        Cal_solt(@Agte507x,Ch$,2,Port(*))
420    END SELECT
430    !
440    OUTPUT @Agte507x;":MMEM:STOR:STYP CST"
450    OUTPUT @Agte507x;":MMEM:STOR """"&File$&""""
460    END
470    !=====
480    ! Calibration Kit Selection Function
490    !=====
500  SUB Select_cal_kit(@Agte507x,Ch$)
510    DIM Cal_kit_lbl$(1:10)[20],Inp_char$[9]
520    INTEGER Cal_kit,I
530    CLEAR SCREEN
540    !
550    FOR I=1 TO 10
560      OUTPUT @Agte507x;":SENS1:CORR:COLL:CKIT ";I
570      OUTPUT @Agte507x;":SENS1:CORR:COLL:CKIT:LAB?"
580      ENTER @Agte507x;Cal_kit_lbl$(I)
590    NEXT I
600    ON ERROR GOTO Kit_select
610  Kit_select: !

```

Performing a Calibration Sample Program

```
620 PRINT "## Calibration Kit Selection ##"
630 FOR I=1 TO 10
640 PRINT USING "X,2D,A,X,20A";I,":",Cal_kit_lbl$(I)
650 NEXT I
660 PRINT ""
670 PRINT "Input 1 to 10"
680 INPUT "Input number? (1 to 10)",Inp_char$
690 Cal_kit=IVAL(Inp_char$,10)
700 IF Cal_kit<1 OR Cal_kit>10 THEN Kit_select
710 OFF ERROR
720 !
730 OUTPUT @Agte507x;":SENS"&Ch$&":CORR:COLL:CKIT ";Cal_kit
740 SUBEND
750 !=====
760 ! Port Selection Function
770 !=====
780 SUB Select_port(INTEGER Num_of_ports,INTEGER Port(*))
790 DIM Inp_char$(9)
800 !
810 CLEAR SCREEN
820 IF Num_of_ports=2 THEN
830 Port(1)=1
840 Port(2)=2
850 ELSE
860 PRINT "## Test Ports Selection ##"
870 ON ERROR GOTO Port_select
880 FOR I=1 TO Num_of_ports
890 PRINT "Port("&VAL$(I)&"):";
900 Port_select: !
910 INPUT "Number?",Inp_char$
920 Port(I)=IVAL(Inp_char$,10)
930 IF Port(I)<1 OR Port(I)>2 THEN Port_select
940 FOR J=1 TO I-1
950 IF Port(I)=Port(J) THEN Port_select
960 NEXT J
970 PRINT Port(I)
980 NEXT I
990 OFF ERROR
1000 END IF
1010 SUBEND
1020 !=====
1030 ! Response (Open/Short) Calibration Function
1040 !=====
1050 SUB Cal_resp(@Agte507x,Ch$,Type$,INTEGER Port)
1060 DIM Buff$(9)
1070 !
1080 PRINT "## Response ("&Type$&") Calibration ##"
1090 OUTPUT @Agte507x;":SENS"&Ch$&":CORR:COLL:METH:"&Type$&";Port
1100 PRINT "Set "&Type$&" to Port "&VAL$(Port)&". Then push [Enter]
key."
1110 INPUT "",Buff$
1120 OUTPUT @Agte507x;":SENS"&Ch$&":CORR:COLL:"&Type$&";Port
1130 OUTPUT @Agte507x;"*OPC?"
1140 ENTER @Agte507x;Buff$
1150 OUTPUT @Agte507x;":SENS"&Ch$&":CORR:COLL:SAVE"
1160 PRINT "Done"
1170 SUBEND
1180 !=====
1190 ! Response (Thru) Calibration Function
1200 !=====
1210 SUB Cal_resp_thru(@Agte507x,Ch$,INTEGER Port1,Port2)
1220 DIM Buff$(9)
1230 !
1240 PRINT "## Response (Thru) Calibration ##"
```

```

1250 OUTPUT @Agte507x;":SENS"&Ch$&":CORR:COLL:METH:THRU
";Port1;";";Port2
1260 PRINT "Set THRU between Port "&VAL$(Port1)&" and Port
"&VAL$(Port2)&". Then push [Enter] key."
1270 INPUT "",Buff$
1280 OUTPUT @Agte507x;":SENS"&Ch$&":CORR:COLL:THRU ";Port1;";";Port2
1290 OUTPUT @Agte507x;"*OPC?"
1300 ENTER @Agte507x;Buff$
1310 OUTPUT @Agte507x;":SENS"&Ch$&":CORR:COLL:SAVE"
1320 PRINT "Done"
1330 SUBEND
1340 !=====
1350 ! Full n Port Calibration Function
1360 !=====
1370 SUB Cal_solt(@Agte507x,Ch$,INTEGER Num_of_ports,INTEGER Port(*)
1380 DIM Buff$(9)
1390 INTEGER I,J
1400 !
1410 PRINT "## Full "&VAL$(Num_of_ports)&" Port Calibration ##"
1420 !
1430 ! Calibration Type Selection
1440 !
1450 OUTPUT
@Agte507x;":SENS"&Ch$&":CORR:COLL:METH:SOLT"&VAL$(Num_of_ports)&" ";
1460 FOR I=1 TO Num_of_ports-1
1470     OUTPUT @Agte507x;Port(I);";";
1480 NEXT I
1490 OUTPUT @Agte507x;Port(Num_of_ports)
1500 !
1510 ! Reflection Measurement
1520 !
1530 FOR I=1 TO Num_of_ports
1540     PRINT "Set OPEN to Port "&VAL$(Port(I))&". Then push [Enter]
key."
1550     INPUT "",Buff$
1560     OUTPUT @Agte507x;":SENS"&Ch$&":CORR:COLL:OPEN ";Port(I)
1570     OUTPUT @Agte507x;"*OPC?"
1580     ENTER @Agte507x;Buff$
1590     PRINT "Set SHORT to Port "&VAL$(Port(I))&". Then push [Enter]
key."
1600     INPUT "",Buff$
1610     OUTPUT @Agte507x;":SENS"&Ch$&":CORR:COLL:SHOR ";Port(I)
1620     OUTPUT @Agte507x;"*OPC?"
1630     ENTER @Agte507x;Buff$
1640     PRINT "Set LOAD to Port "&VAL$(Port(I))&". Then push [Enter]
key."
1650     INPUT "",Buff$
1660     OUTPUT @Agte507x;":SENS"&Ch$&":CORR:COLL:LOAD ";Port(I)
1670     OUTPUT @Agte507x;"*OPC?"
1680     ENTER @Agte507x;Buff$
1690 NEXT I
1700 !
1710 ! Transmission Measurement
1720 !
1730 FOR I=1 TO Num_of_ports-1
1740     FOR J=I+1 TO Num_of_ports
1750         PRINT "Set THRU between Port "&VAL$(Port(I))&" and Port
"&VAL$(Port(J))&". Then push [Enter] key."
1760         INPUT "",Buff$
1770         OUTPUT @Agte507x;":SENS"&Ch$&":CORR:COLL:THRU
";Port(I);";";Port(J)
1780         OUTPUT @Agte507x;"*OPC?"
1790         ENTER @Agte507x;Buff$
1800         OUTPUT @Agte507x;":SENS"&Ch$&":CORR:COLL:THRU

```

Performing a Calibration

Sample Program

```
";Port(J);",";Port(I)
1810      OUTPUT @Agte507x;"*OPC?"
1820      ENTER @Agte507x;Buff$
1830      NEXT J
1840     NEXT I
1850      !
1860      ! Done
1870      !
1880     OUTPUT @Agte507x;":SENS"&Ch$&":CORR:COLL:SAVE"
1890     PRINT "Done"
1900 SUBEND
```

ECal

Example 4-2 shows a sample program that demonstrates how to use ECal. You can find the source file of this program, named `ecal.htb`, on the sample program disk.

The sample program performs full 1-port or 2-port calibration using ECal, and saves the results to a file named “`Ex_4_2.sta`.”

The program is described in detail below:

Line 40	Assigns a GPIB address to the I/O pass.
Line 50	Stores the name of the file (<code>Ex_4_2.sta</code>) into the <code>File\$</code> variable.
Line 60	Stores the channel number (1) into the <code>Ch\$</code> variable.
Line 90	Allows the user to return to the entry start line and re-enter the data if an error (such as an invalid entry) occurs while selecting the calibration type number.
Lines 110 to 160	These lines display the list of supported calibration types, and prompt the user to choose one of the items by typing in the appropriate number.
Line 170	Converts the entered value into an integer and stores it into the <code>Cal_type</code> variable.
Line 180	Returns to the entry start line if an invalid value is contained in <code>Cal_type</code> .
Lines 210 to 220	These lines call a subprogram named <code>Select_port</code> to select the appropriate port based on the value of <code>Cal_type</code> , and then perform ECal.
Lines 240 to 250	These lines configure the system to save calibration coefficients along with instrument settings, and then save the instrument settings under the file name contained in the <code>File\$</code> variable.

For more information on the `Select_port` subprogram (lines 300 to lines 530), refer to the description in Example 4-1.

Performing a Calibration

Sample Program

The ECal subprogram in lines 570 to 870, which performs ECal, is described below.

Line 610	Displays the calibration type.
Line 630	Clears the error queue.
Lines 660 to 680	If Num_of_ports = 1, the subprogram prompts the user to connect the E5061A/E5062A's port Port(1) with the ECal module, and waits for a press of the [Enter] key after the connection.
Line 690	If Num_of_ports = 1, the subprogram executes the ECal command that performs full 1-port calibration on port Port(1).
Lines 710 to 740	If Num_of_ports = 2, the subprogram prompts the user to connect the E5061A/E5062A's ports Port(1) and Port(2) with the ECal module, and waits for a press of the [Enter] key after the connection.
Line 750	If Num_of_ports = 2, the subprogram executes the ECal command that performs full 2-port calibration on ports Port(1) and Port(2).
Lines 780 to 790	These lines retrieve the error number and error message from the error queue, and then store them into the variables Err_no and Err_msg\$, respectively.

NOTE

The ECal command can be combined with the ***OPC?** command to make the program wait until the measurement completes successfully. The sample program executes the **:SYST:ERR?** for the purposes of waiting for the completion of ECal and checking for any errors.

Lines 810 to 830	If Err_no returns a non-zero value (an error value), the program displays the corresponding error message.
Line 850	If Err_no returns 0 (no error), the program displays a closing message.

Example 4-2

ECal (ecal.htb)

```

10     DIM File$(20),Ch$(9),Inp_char$(9)
20     INTEGER Cal_kit,Cal_type,Port(1:2)
30     !
40     ASSIGN @Agte507x TO 717
50     File$="Ex_4_2.sta"
60     Ch$="1"
70     !
80     CLEAR SCREEN
90     ON ERROR GOTO Type_select
100    Type_select: !
110    PRINT "## Calibration Type Selection ##"
120    PRINT " 1: Full 1 Port"
130    PRINT " 2: Full 2 Port"
140    PRINT ""
150    PRINT "Input 1 to 2"
160    INPUT "Input number? (1 to 2)",Inp_char$
170    Cal_type=IVAL(Inp_char$,10)
180    IF Cal_type<1 OR Cal_type>2 THEN Type_select
190    OFF ERROR
200    !
210    Select_port(Cal_type,Port(*))
220    Ecal(@Agte507x,Ch$,Cal_type,Port(*))
230    !
240    OUTPUT @Agte507x;":MMEM:STOR:STYP CST"
250    OUTPUT @Agte507x;":MMEM:STOR ""&File$&""""
260    END
270    !=====
280    ! Port Selection Function
290    !=====
300    SUB Select_port(INTEGER Num_of_ports,INTEGER Port(*))
310    DIM Inp_char$(9)
320    !
330    CLEAR SCREEN
340    IF Num_of_ports=2 THEN
350        Port(1)=1
360        Port(2)=2
370    ELSE
380        PRINT "## Test Ports Selection ##"
390        ON ERROR GOTO Port_select
400        FOR I=1 TO Num_of_ports
410            PRINT "Port("&VAL$(I)&"):";
420    Port_select: !
430        INPUT "Number?",Inp_char$
440        Port(I)=IVAL(Inp_char$,10)
450        IF Port(I)<1 OR Port(I)>2 THEN Port_select
460        FOR J=1 TO I-1
470            IF Port(I)=Port(J) THEN Port_select
480        NEXT J
490        PRINT Port(I)
500    NEXT I
510    OFF ERROR
520    END IF
530    SUBEND
540    !=====
550    ! Electronic Calibration Function
560    !=====
570    SUB Ecal(@Agte507x,Ch$,INTEGER Num_of_ports,INTEGER Port(*))
580    DIM Buff$(9),Err_msg$(100)
590    INTEGER Err_no,Port1
600    !
610    PRINT "## Full "&VAL$(Num_of_ports)&" Port ECal ##"

```

Performing a Calibration Sample Program

```
620      !
630      OUTPUT @Agte507x;"*CLS"
640      SELECT Num_of_ports
650          CASE 1
660              PRINT "Connect Port "&VAL$(Port(1))&" to ECal Module."
670              PRINT "Then push [Enter] key."
680              INPUT "",Buff$
690              OUTPUT @Agte507x;":SENS"&Ch$&":CORR:COLL:ECAL:SOLT1 ";Port(1)
700          CASE 2
710              PRINT "Connect Port "&VAL$(Port(1));
720              PRINT " and Port "&VAL$(Port(2))&" to ECal Module."
730              PRINT "Then push [Enter] key."
740              INPUT "",Buff$
750              OUTPUT @Agte507x;":SENS"&Ch$&":CORR:COLL:ECAL:SOLT2
";Port(1);",";Port(2)
760      END SELECT
770      PRINT "Executing ..."
780      OUTPUT @Agte507x;":SYST:ERR?"
790      ENTER @Agte507x;Err_no,Err_msg$
800      IF Err_no<>0 THEN
810          PRINT "Error occurred!!"
820          PRINT "  No:";Err_no,"Description: "&Err_msg$
830          PRINT "ECAL INTERRUPT!!"
840      ELSE
850          PRINT "Done"
860      END IF
870  SUBEND
```

5 Making a Measurement

This chapter describes how to trigger the instrument to start a new measurement cycle and how to detect the end of a measurement cycle.

Trigger system

The trigger system is responsible for such tasks as detecting the start of a measurement cycle (triggering) and enabling/disabling measurement on each channel. As shown in Figure 5-1, the trigger system has two types of state: system-wide and channel-wide. The system-wide state can be “Hold”, “Waiting for Trigger”, or “Measurement” while the channel-wide state can be “Idle” or “Initiate”.

Figure 5-1

Trigger system

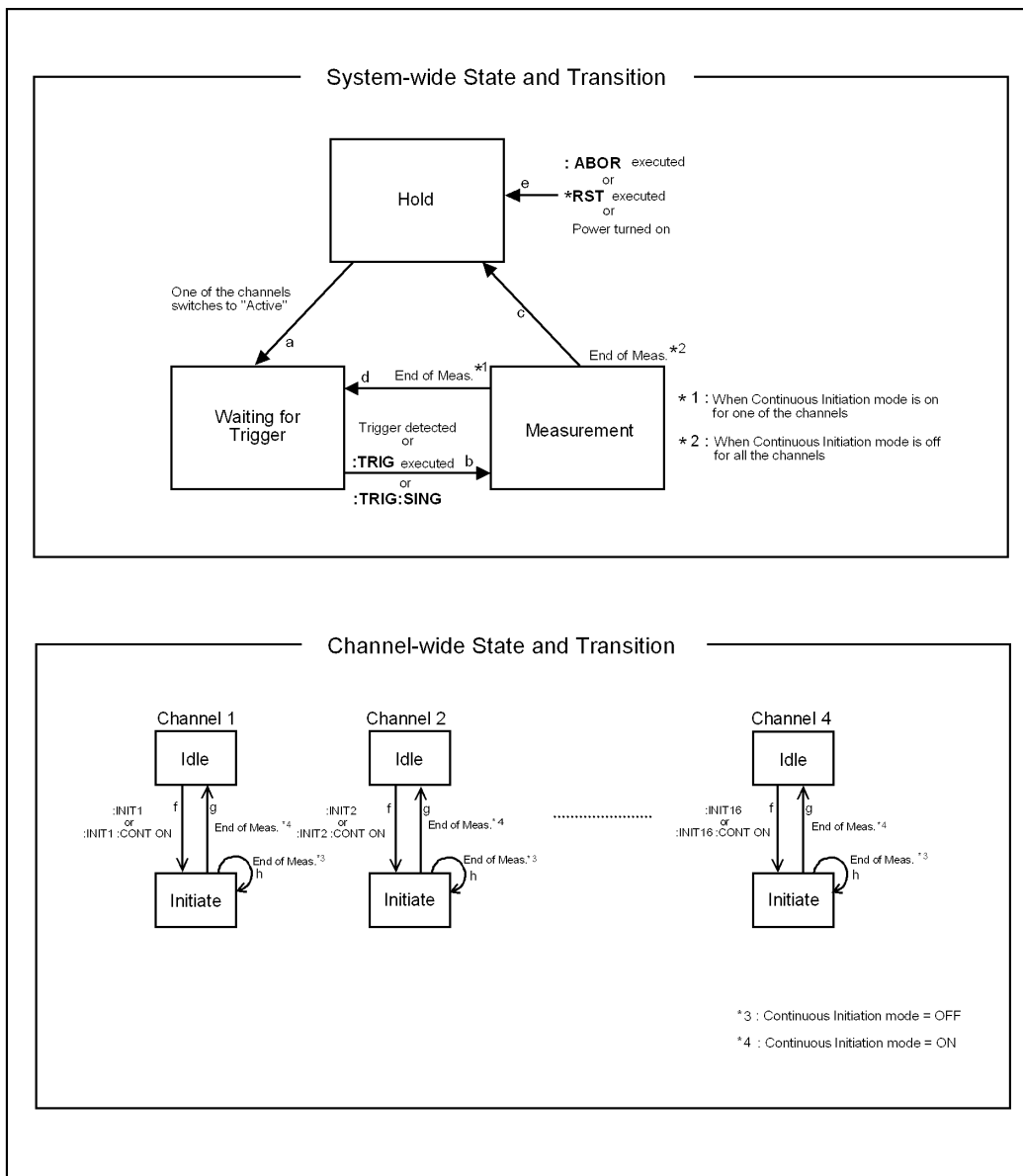

e5061ape0401

The following subsections describe each state and how the trigger system switches among the states.

System-wide state and transition

“Hold” State

The trigger system switches to “Hold” state when one of the following commands has been executed (arrow “e” in Figure 5-1). Also, turning on the power to the instrument puts the trigger system into “Hold” state. When the power is turned on, however, continuous initiation mode is on for channel 1 and the trigger source is set to “Internal”; therefore, the trigger system immediately switches to “Waiting for Trigger” state and subsequently repeats transitions between “Measurement” and “Waiting for Trigger” states.

- :ABOR on page 200
- *RST on page 197

When the trigger system is in “Hold” state and one of the channels switches to “Initiate” state (arrow “f” in Figure 5-1), then the trigger system switches to “Waiting for Trigger” state (arrow “a” in Figure 5-1).

“Waiting for Trigger” State

When the trigger system is in “Waiting for Trigger” state and either the instrument is triggered (i.e., a trigger is detected) or one of the commands is executed, then the trigger system switches to “Measurement” state (arrow “B” in Figure 5-1).

- :TRIG on page 482
- :TRIG:SING on page 482

As shown in the table below, how the instrument is triggered differs depending on which trigger source is specified. To specify the trigger source, use the :TRIG:SOUR command on page 483 command.

Trigger Source	How the instrument is triggered
Internal trigger	The instrument is automatically triggered within itself.
External trigger	The instrument is triggered when a trigger signal is input through the Ext Trig terminal or handler interface.
Bus trigger	The instrument is triggered when the *TRG command on page 199 command is issued.
Manual trigger	The instrument is triggered when you press [Trigger] - Trigger on the front panel.

Making a Measurement Trigger system

“Measurement” State

In “Measurement” state, the instrument waits for the elapse of the sweep delay time (set by the :SENS{1-4}:SWE:DEL command on page 422) and then starts a measurement cycle; this process is performed sequentially on each of those channels that were in “Initiate” state immediately before the transition to this state, in the ascending order of the channel numbers.

When the instrument has finished measuring all the active channels, the trigger system behaves in one of the following ways depending on the setting of continuous initiation mode.

If continuous initiation mode is off for all the channels:

The trigger system switches to “Hold” state (arrow “c” in Figure 5-1).

If continuous initiation mode is on for one of the channels:

The trigger system switches to “Waiting for Trigger” state (arrow “d” in Figure 5-1).

Channel-wide state and transition

“Idle” State

A channel switches to “Initiate” state when one of the following commands has been executed (arrow “f” in Figure 5-1).

- :INIT{1-4} on page 338
- :INIT{1-4}:CONT on page 339 (“ON” specified)

“Initiate” State

A channel in this state is measured just before the entire system switches to “Measurement” state.

When the instrument has finished measuring a channel, the channel behaves in one of the following ways depending on the setting of continuous initiation mode (set by the :INIT{1-4}:CONT command on page 339 command).

If continuous initiation mode is off: The channel switches to “Idle” state (arrow “g” in Figure 5-1).

If continuous initiation mode is on: The channel remains in “Initiate” state (arrow “h” in Figure 5-1).

Starting a Measurement Cycle (Triggering the instrument)

Configuring the Instrument to Automatically Perform Continuous Measurement

- Step 1.** Use the `:INIT{1-4}:CONT` command on page 339 to turn on continuous initiation mode for the channels you want to measure and turn the mode off for any other channels.
- Step 2.** Issue the `:TRIG:SOUR` command on page 483 to set the trigger source to Internal trigger.

Starting Measurement on Demand

- Step 1.** Use the `:INIT{1-4}:CONT` command to turn on continuous initiation mode for the channels you want to measure and turn the mode off for any other channels.
- Step 2.** Issue the `:TRIG:SOUR` command to set the trigger source to “Bus Trigger”.
- Step 3.** Trigger the instrument at any time you want to perform measurement. An external controller can trigger the instrument using one of the following three commands:

Command	Can the *OPC? command on page 196 command be used to wait for the end of sweep?	Applicable trigger source
*TRG on page 199	No	Bus trigger only
:TRIG on page 482		External trigger
:TRIG:SING on page 482	Yes	Bus trigger Manual trigger

- Step 4.** To start the next measurement cycle, repeat step 3.

Waiting for the End of Measurement

Using the Status Register

The status of the E5061A/E5062A can be detected through the status registers. This section describes how to detect the end of measurement using the status registers. For the complete description of the status report mechanism, including the specifications of each bit, see Appendix B, “Status Reporting System.”

Measurement status is reported by the operation status condition register (see Table B-3 on page 516). An SRQ (service request) is useful when you create a program that uses the information reported by this register to detect the end of measurement.

To detect the end of measurement via an SRQ, use one of the following commands:

- *SRE on page 198
- :STAT:OPER:ENAB on page 440
- :STAT:OPER:PTR on page 442
- :STAT:OPER:NTR on page 441

Follow these steps:

- Step 1.** Configure the E5061A/E5062A so that it generates an SRQ when the operation status condition register's bit 4 (a bit that is set to 1 during measurement) is changed from 1 to 0.
- Step 2.** Trigger the instrument to start a measurement cycle.
- Step 3.** When an SRQ is generated, the program interrupts the measurement cycle.

Figure 5-2

SRQ generation sequence (at the end of measurement)

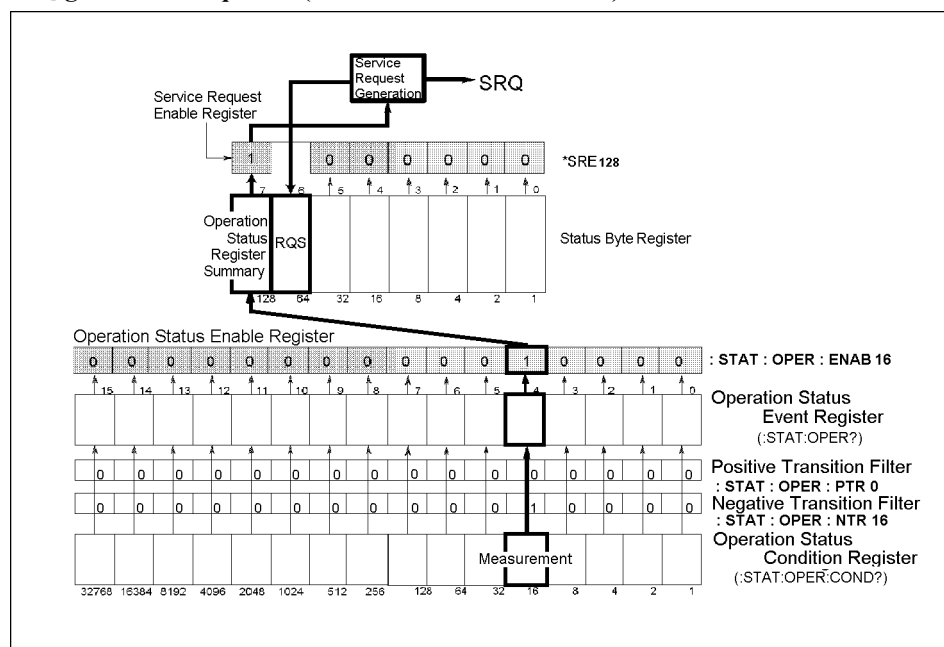

4287ape007

Sample Program

Example 5-2 is a sample program that demonstrates how to use an SRQ to detect the end of measurement. You can find the source file of this program, named `srq_meas.htb`, on the sample program disk.

NOTE

This sample program correctly runs when the maximum number of channels/traces is set 9 channels/9 traces.

The sample program sets up the trigger system, configures the instrument to properly generate an SRQ, and then triggers the instrument. When the instrument has generated an SRQ that indicates the end of measurement, the program exits after printing a measurement completion message.

The program is described in detail below:

- Line 40 Assigns a GPIB address to the I/O pass.
- Lines 60 to 90 These lines store the settings of continuous initiation mode for each channel (on for channels 1 and 2; off for channels 3 through 4) into the array variable `Cont_mode$(*)`.
- Lines 110 to 130 These lines turn on or off continuous initiation mode for each channel depending on the value of `Cont_mode$(*)`.
- Line 140 Sets the trigger source to “Bus Trigger”.
- Lines 160 to 170 These lines configure the instrument so that operation status event register's bit 4 is set to 1 only when operation status condition register's bit 4 is changed from 1 to 0 (negative transition).
- Lines 180 to 190 These lines enable the operation status event register's bit 4 and status byte register's bit 7.
- Lines 200 to 220 These lines clear the status byte register and operation status event register.
- Lines 240 to 250 These lines set the branch target for an SRQ interrupt to enable SRQ interrupts.
- Lines 260 to 290 These lines trigger the instrument, and waits until the measurement cycle finishes.
- Line 300 Displays a measurement completion message.

Making a Measurement

Waiting for the End of Measurement

Example 5-1

Using an SRQ to Detect the End of Measurement (srq_meas.htb)

```
10     DIM Cont_mode$(1:4) [9], Buff$ [9]
20     INTEGER I
30     !
40     ASSIGN @Agte507x TO 717
50     !
60     Cont_mode$(1) = "ON"
70     Cont_mode$(2) = "ON"
80     Cont_mode$(3) = "OFF"
90     Cont_mode$(4) = "OFF"
100    !
110    FOR I=1 TO 4
120        OUTPUT @Agte507x; ":INIT"&VAL$(I) & ":CONT "&Cont_mode$(I)
130    NEXT I
140    OUTPUT @Agte507x; ":TRIG:SOUR BUS"
150    !
160    OUTPUT @Agte507x; ":STAT:OPER:PTR 0"
170    OUTPUT @Agte507x; ":STAT:OPER:NTR 16"
180    OUTPUT @Agte507x; ":STAT:OPER:ENAB 16"
190    OUTPUT @Agte507x; "*SRE 128"
200    OUTPUT @Agte507x; "*CLS"
210    OUTPUT @Agte507x; "*OPC?"
220    ENTER @Agte507x; Buff$
230    !
240    ON INTR 7 GOTO Meas_end
250    ENABLE INTR 7;2
260    OUTPUT @Agte507x; "*TRG"
270    PRINT "Waiting..."
280 Meas_wait: GOTO Meas_wait
290 Meas_end:  OFF INTR 7
300    PRINT "Measurement Complete"
310    END
```

Using the :TRIG:SING Command

When you trigger the instrument by issuing the :TRIG:SING command on page 482 command, you can use the *OPC? command to wait until the measurement cycle completes.

Sample Program

Example 5-2 is a sample program that demonstrates how to use the :TRIG:SING command to wait until the measurement cycle completes. You can find the source file of this program, named trg_sing.htb, on the sample program disk.

The sample program uses the :TRIG:SING command to start a sweep (measurement) cycle, uses the *OPC? command to wait until the measurement cycle completes, then prints a message and exits.

The program is described in detail below:

Line 40	Assigns a GPIB address to the I/O pass.
Lines 60 to 90	These lines store the settings of continuous initiation mode for each channel (on for channels 1 and 2; off for channels 3 through 4) into the array variable Cont_mode\$(*).
Lines 110 to 130	These lines turn on or off continuous initiation mode for each channel depending on the value of Cont_mode\$(*).
Line 140	Sets the trigger source to “Bus Trigger”.
Line 160	Triggers the instrument to start a sweep cycle.
Lines 170 to 180	These lines execute the *OPC? command and wait until the command returns 1 (i.e., the measurement cycle completes).
Line 200	Displays a measurement completion message.

Making a Measurement

Waiting for the End of Measurement

Example 5-2

Using the :TRIG:SING Command to Wait until the End of Measurement (trg_sing.htb)

```
10     DIM Cont_mode$(1:4) [9], Buff$ [9]
20     INTEGER I
30     !
40     ASSIGN @Agte507x TO 717
50     !
60     Cont_mode$(1) = "ON"
70     Cont_mode$(2) = "ON"
80     Cont_mode$(3) = "OFF"
90     Cont_mode$(4) = "OFF"
100    !
110    FOR I=1 TO 4
120        OUTPUT @Agte507x; ":INIT"&VAL$(I) & ":CONT "&Cont_mode$(I)
130    NEXT I
140    OUTPUT @Agte507x; ":TRIG:SOUR BUS"
150    !
160    OUTPUT @Agte507x; ":TRIG:SING"
170    OUTPUT @Agte507x; "*OPC?"
180    ENTER @Agte507x; Buff$
190    !
200    PRINT "Measurement complete"
210    END
```

Using Wait Time

Before creating your program, actually measure the time between the start and end of the measurement cycle. Then code your program so that the controller waits for the actually measured time using the appropriate command (for example, the WAIT command for HTBasic). This is a straightforward method, but care must be taken: an incorrect wait time could result in an unexpected error.

6 Analyzing Data

This chapter describes how to use markers and analysis command.

Retrieving Measurement Results at Specified Points

Markers allow you to retrieve measurement results at your specified points. You can use up to eight markers for each trace, and you can move them to any point on the trace. In addition to the regular markers, you can use a reference marker.

Showing/Hiding Markers

To show or hide markers including the reference marker, use the following command:

- :CALC{1-4}:MARK{1-10} on page 261

NOTE You can move markers or retrieve the data at a marker even when the markers are hidden.

NOTE The display of the reference marker is turned on or off when you turn on or off Reference Marker mode.

Turning On or Off Reference Marker Mode

Turning on Reference Marker mode provides relative marker values with respect to the reference marker (by deducting the value at the reference marker from the value at a particular marker).

To turn on or off Reference Marker mode, use the following command:

- :CALC{1-4}:MARK:REF on page 260

Setting (Changing) and Retrieving Stimulus Value at Marker Positions

To set (or change along the frequency axis) the stimulus value at a particular marker or the reference maker or retrieve the current stimulus value, use the following command:

- :CALC{1-4}:MARK{1-10}:X on page 277

When Reference Marker mode is on, the stimulus value at a regular marker is a relative stimulus value obtained by deducting the stimulus value at the reference marker from the actual stimulus value at that particular marker.

Retrieving Measurement Results at Marker Positions

To retrieve the measurement results (response values) at a particular marker or the reference marker, use the following command:

- :CALC{1-4}:MARK{1-10}:Y? on page 278

When Reference Marker mode is on, the response value at a regular marker is a relative value obtained by deducting the response value at the reference marker from the actual response value at that particular marker.

Searching for Positions That Match Specified Criteria

You can search for a position that matches your specified criteria using the Marker Search feature or analysis command.

Using Marker Search

NOTE

Marker Search is available whether the markers are shown or hidden.

Setting the Search Range

You can use either the entire sweep range or a user-defined range for the marker search range, using the following command:

- `:CALC{1-4}:MARK:FUNC:DOM` on page 243

When you opt to use a user-defined range, use the following command to set the range:

Start value (lower limit value)	<code>:CALC{1-4}:MARK:FUNC:DOM:STAR</code> on page 245
Stop value (upper limit value)	<code>:CALC{1-4}:MARK:FUNC:DOM:STOP</code> on page 246

You can also select whether to specify the marker search range independently for each trace, using the following command.

- `:CALC{1-4}:FUNC:DOM:COUP` on page 221

Selecting a Search Type

Marker Search allows you to choose from the following eight search types:

- Maximum value
- Minimum value
- Peak (3 types)
 - Maximum peak (for a positive peak), minimum peak (for a negative peak)
 - Peak nearest to the left-hand side of the marker position
 - Peak nearest to the right-hand side of the marker position
- Target (3 types)
 - Peak nearest to the marker position
 - Target nearest to the left-hand side of the marker position
 - Target nearest to the right-hand side of the marker position

To select a search type, use the following command:

- `:CALC{1-4}:MARK{1-10}:FUNC:TYPE` on page 272

Analyzing Data

Searching for Positions That Match Specified Criteria

Defining a Peak

You can define a peak by specifying the lower limit for the peak excursion value and polarity (positive or negative peak). The peak excursion value is the difference between the positive peak and the minimum value on either side (or between the negative peak and the maximum value on either side). For more information about the peak excursion value, see *User's Guide*.

To define a peak, use the following command:

lower limit for the peak excursion value	:CALC{1-4}:MARK{1-10}:FUNC:PEXC on page 267
polarity	:CALC{1-4}:MARK{1-10}:FUNC:PPOL on page 268

Defining a Target

You can define a target by specifying the target value (response value) and transitional direction (positive or negative value change).

To define a target, use the following command:

Target value	:CALC{1-4}:MARK{1-10}:FUNC:TARG on page 269
Transitional direction	:CALC{1-4}:MARK{1-10}:FUNC:TTR on page 271

Performing Marker Search

To perform Marker Search, use the following command:

- :CALC{1-4}:MARK{1-10}:FUNC:EXEC on page 266

To turn on or off the Search Tracking feature, which performs Marker Search every time the trace is updated, use the following command:

- :CALC{1-4}:MARK{1-10}:FUNC:TRAC on page 270

Retrieving Search Results

Performing Marker Search moves the marker to the points that matches the search criteria, so you can obtain the search results by retrieving the marker value. For information on how to retrieve marker values, refer to “Setting (Changing) and Retrieving Stimulus Value at Marker Positions” on page 88 and “Retrieving Measurement Results at Marker Positions” on page 88.

Using the Analysis Command

You can use the analysis command to perform search and analysis.

Setting the Search (Analysis) Range

You can use either the entire sweep range or a user-defined range as the search (analysis) range, using the following command:

- :CALC{1-4}:FUNC:DOM on page 220

When you opt to use a user-defined range, use the following command to set the range:

Start value (lower limit value)	:CALC{1-4}:FUNC:DOM:STAR on page 222
Stop value (upper limit value)	:CALC{1-4}:FUNC:DOM:STOP on page 223

You can also select whether to specify the marker search (analysis) range independently for each trace, using the following command.

- :CALC{1-4}:FUNC:DOM:COUP on page 221

Selecting the Search (Analysis) Type

The analysis command allows you to choose from the following five search types:

- Maximum value
- Minimum value
- Maximum peak (for a positive peak), minimum peak (for a negative peak)
- All peaks
- All targets

In addition, you can choose from the following three analysis types:

- Difference between the maximum and minimum values
- Standard deviation
- Average

To select the search (analysis) type, use the following command:

- :CALC{1-4}:FUNC:TYPE on page 229

Defining a Peak

You can define a peak by specifying the lower limit for the peak excursion value and polarity (positive or negative peak). The peak excursion value is the difference between the positive peak and the minimum value on either side (or between the negative peak and the maximum value on either side). For more information about the peak excursion value, see *User's Guide*.

To define a peak, use the following command:

lower limit for the peak excursion value	:CALC{1-4}:FUNC:PEXC on page 224
Polarity	:CALC{1-4}:FUNC:PPOL on page 226

Analyzing Data

Searching for Positions That Match Specified Criteria

Defining a Target

You can define a target by specifying the target value (response value) and transitional direction (positive or negative value change).

To define a target, use the following command:

Target value	:CALC{1-4}:FUNC:TARG on page 227
Transitional direction	:CALC{1-4}:FUNC:TTR on page 228

Performing Search (Analysis)

To perform search (analysis), use the following command:

- :CALC{1-4}:FUNC:EXEC on page 223

Retrieving Search (Analysis) Results

To retrieve search (analysis) results, use the following command:

- :CALC{1-4}:FUNC:DATA? on page 219

The number of the data items contained in search (analysis) results differ depending on the search (analysis) type and the number of points found by the search operation. To retrieve the number of data items, use the following command:

- :CALC{1-4}:FUNC:POIN? on page 225

Sample Program

Example 6-2 is a sample program that demonstrates how to search for peaks using the Marker Search feature and analysis command. You can find the source file of this program, named `search.hrb`, on the sample program disk.

This program works in two steps: it uses Marker Search to search for the maximum positive peak and displays the results; it then uses analysis command to search for all positive peaks and displays the results.

The program is described in detail below:

Line 50	Assigns a GPIB address to the I/O pass.
Line 60	Stores a peak excursion value of 0.5 into the Excursion variable.
Lines 80 to 120	These lines configure the system to generate an SRQ when it cannot perform Bandwidth Search due to an error.
Lines 130 to 140	These lines set the branch target for an SRQ interrupt to enable SRQ interrupts.
Line 180	Sets the active trace to trace 1.
Line 190	Sets the search type for marker 1 to Peak.
Lines 200 to 210	These lines set the Excursion variable to the peak excursion value for the peak search of marker 1 and set the polarity to Positive Peak.
Line 220	Performs Peak Search, and moves marker 1 to the maximum positive peak.
Lines 230 to 240	These lines retrieve the frequency at marker 1.
Lines 250 to 260	These lines retrieve the response value at marker 1.
Lines 270 to 290	These lines display the results of searching for the maximum positive peak.
Line 330	Sets the analysis range to the entire sweep range.
Line 340	Sets the search type of the analysis command to All Peaks.
Lines 350 to 360	These lines set the Excursion variable to the peak excursion value for the peak search of the analysis command and set the polarity to Positive Peak.
Line 370	Searches for all peaks.
Lines 380 to 390	These lines retrieve the number of data pairs contained in the search results, and stores that number into the Point variable.
Line 400	Resizes the Result array based on the value of the Point variable.
Lines 380 to 390	These lines retrieve the response values and frequencies for all peaks.
Lines 430 to 470	These lines display the results of searching for all peaks.
Lines 490 to 530	These lines define an error handler that retrieves and displays the number and message of an error that has occurred.

Analyzing Data

Searching for Positions That Match Specified Criteria

Example 6-1

Peak Search (search.htb)

```
10     DIM Buff$(9),Img$(50),Err_msg$(100)
20     REAL Excursion,Freq,Resp,Result(1:100,1:2)
30     INTEGER Poin,Err_no
40     !
50     ASSIGN @Agte507x TO 717
60     Excursion=.5
70     !
80     OUTPUT @Agte507x;"*ESE 60"
90     OUTPUT @Agte507x;"*SRE 32"
100    OUTPUT @Agte507x;"*CLS"
110    OUTPUT @Agte507x;"*OPC?"
120    ENTER @Agte507x;Buff$
130    ON INTR 7 GOTO Err
140    ENABLE INTR 7;2
150    !
160    PRINT "Maximum Peak Search using Marker 1"
170    !
180    OUTPUT @Agte507x;":CALC1:PAR1:SEL"
190    OUTPUT @Agte507x;":CALC1:MARK1:FUNC:TYPE PEAK"
200    OUTPUT @Agte507x;":CALC1:MARK1:FUNC:PEXC ";Excursion
210    OUTPUT @Agte507x;":CALC1:MARK1:FUNC:PPOL POS"
220    OUTPUT @Agte507x;":CALC1:MARK1:FUNC:EXEC"
230    OUTPUT @Agte507x;":CALC1:MARK1:X?"
240    ENTER @Agte507x;Freq
250    OUTPUT @Agte507x;":CALC1:MARK1:Y?"
260    ENTER @Agte507x;Resp
270    Img$="8A,MD.4DE,2X,MD.6DE"
280    PRINT "          Frequency          Response"
290    PRINT USING Img$;"Peak:    ",Freq,Resp
300    !
310    PRINT "All Peaks Search using Command"
320    !
330    OUTPUT @Agte507x;":CALC1:FUNC:DOM OFF"
340    OUTPUT @Agte507x;":CALC1:FUNC:TYPE APE"
350    OUTPUT @Agte507x;":CALC1:FUNC:PEXC ";Excursion
360    OUTPUT @Agte507x;":CALC1:FUNC:PPOL POS"
370    OUTPUT @Agte507x;":CALC1:FUNC:EXEC"
380    OUTPUT @Agte507x;":CALC1:FUNC:POIN?"
390    ENTER @Agte507x;Poin
400    REDIM Result(1:Poin,1:2)
410    OUTPUT @Agte507x;":CALC1:FUNC:DATA?"
420    ENTER @Agte507x;Result(*)
430    Img$="4A,2D,2A,MD.4DE,2X,MD.6DE"
440    PRINT "          Frequency          Response"
450    FOR I=1 TO Poin
460        PRINT USING Img$;"Peak",I,"": ",Result(I,2),Result(I,1)
470    NEXT I
480    GOTO No_err
490 Err: OFF INTR 7
500    OUTPUT @Agte507x;":SYST:ERR?"
510    ENTER @Agte507x;Err_no,Err_msg$
520    PRINT "Error occurred!!"
530    PRINT "  No: ";Err_no,"Description: "&Err_msg$
540 No_err: OFF INTR 7
550    END
```

Bandwidth Search

The E5061A/E5062A has a feature called Bandwidth Search. This feature searches for the cutoff points on both right- and left-hand sides of the marker position on the trace.

- Bandwidth ($BW = high - low$)
- Center frequency ($cent = \frac{high + low}{2}$)
- Q value ($Q = \frac{cent}{BW}$)
- Loss (response value at the marker position)

Where *high* is the right-hand cutoff point frequency; *low* is the left-hand cutoff point frequency.

Setting the Bandwidth Definition Value

Bandwidth Search finds a point whose response value is different, by the amount defined as the bandwidth definition value, than the response value at the marker position, and identifies that point as the cutoff point.

To set the bandwidth definition value, use the following command:

- :CALC{1-4}:MARK{1-10}:BWID:THR on page 264

Retrieving Bandwidth Search Results

Once you have moved the marker to the appropriate position using Marker Search or some other feature, you can retrieve the results of Bandwidth Search using the following command:

- :CALC{1-4}:MARK{1-10}:BWID:DATA? on page 263

Also, you can use the following command to control whether to display the results of Bandwidth Search on the LCD:

- :CALC{1-4}:MARK:BWID on page 241

NOTE

You can retrieve the results of Bandwidth Search even after you have turned off the display of markers or the results of Bandwidth Search.

Sample Program

Example 6-2 shows a sample program that demonstrates how to perform Bandwidth Search. You can find the source file of this program, named `bandwid.htb`, on the sample program disk.

The sample program moves the marker to the maximum value position, then retrieves and displays the results of Bandwidth Search.

The program is described in detail below:

- Line 50 Assigns a GPIB address to the I/O pass.
- Line 60 Stores a bandwidth definition value of 3 into the Threshold variable.

Analyzing Data

Bandwidth Search

Lines 80 to 120	These lines configure the system to generate an SRQ when it cannot perform Bandwidth Search due to an error.
Lines 130 to 140	These lines set the branch target for an SRQ interrupt to enable SRQ interrupts.
Line 160	Sets the search type for marker 1 to Peak.
Lines 170 to 180	These lines use the Marker Search feature to move the marker to the maximum value position.
Line 190	Sets the bandwidth definition value to Threshold.
Lines 200	Sends the command to retrieve the results of Bandwidth Search.
Lines 210	Waits 0.5 seconds to prevent the retrieve before an SRQ is generated if an error occurs on Bandwidth Search.
Lines 220	Retrieves the results of Bandwidth Search.
Lines 240 to 280	These lines display the results of Bandwidth Search.
Lines 310 to 350	These lines define an error handler that retrieves and displays the number and message of an error that has occurred.

Example 6-2

Bandwidth Search (bandwid.htb)

```
10 DIM Buff$(9),Err_msg$(100)
20 REAL Threshold,Bwid,Cent,Q, Loss
30 INTEGER Err_no
40 !
50 ASSIGN @Agte507x TO 717
60 Threshold=-3
70 !
80 OUTPUT @Agte507x;"*ESE 60"
90 OUTPUT @Agte507x;"*SRE 32"
100 OUTPUT @Agte507x;"*CLS"
110 OUTPUT @Agte507x;"*OPC?"
120 ENTER @Agte507x;Buff$
130 ON INTR 7 GOTO Err
140 ENABLE INTR 7;2
150 !
160 OUTPUT @Agte507x;":CALC1:PAR1:SEL"
170 OUTPUT @Agte507x;":CALC1:MARK1:FUNC:TYPE MAX"
180 OUTPUT @Agte507x;":CALC1:MARK1:FUNC:EXEC"
190 OUTPUT @Agte507x;":CALC1:MARK1:BWID:THR ";Threshold
200 OUTPUT @Agte507x;":CALC1:MARK1:BWID:DATA?"
210 WAIT .5
220 ENTER @Agte507x;Bwid,Cent,Q, Loss
230 !
240 PRINT "## Bandwidth Search ##"
250 PRINT "Bandwidth : ",Bwid
260 PRINT "Center Frequency: ",Cent
270 PRINT "Q : ",Q
280 PRINT "Loss : ",Loss
290 !
300 GOTO No_err
310 Err: OFF INTR 7
320 OUTPUT @Agte507x;":SYST:ERR?"
330 ENTER @Agte507x;Err_no,Err_msg$
340 PRINT "Error occurred!!"
350 PRINT " No: ";Err_no,"Description: "&Err_msg$
360 No_err: OFF INTR 7
370 END
```

Notch search

The E5061A/E5062A provides the notch search function. This function searches for points that meet the conditions on the trace, initiated at the marker position and sweeping the trace rightward, and calculates the following items.

- Bandwidth ($BW = high - low$)
- Center frequency ($cent = \frac{high + low}{2}$)
- Q value ($Q = \frac{cent}{BW}$)
- Loss (response value at the marker position)

Where, *high* is the right-hand cutoff point frequency, and *low* is the left-hand cutoff point frequency.

Setting the notch definition value

The notch search function finds a point whose response value is different, by the amount defined as the notch definition value, than the response value at the marker position, and identifies that point as the cutoff point.

To set the notch definition value, use the following command:

- :CALC{1-4}:MARK{1-10}:BWID:THR on page 264

Reading out the notch search result

Once you have moved the marker to the appropriate position using the marker search function or some other function, you can retrieve the notch search result using the following command:

- :CALC{1-4}:MARK{1-10}:NOTC:DATA? on page 274

Also, you can use the following command to control whether to display the notch search result on the LCD:

- :CALC{1-4}:MARK:NOTC on page 259

NOTE

You can retrieve the notch search result regardless of whether the marker display and the notch search result display is on/off.

Statistical Analysis

The E5061A/E5062A provides a mechanism that analyzes trace statistics. You can analyze the following statistics:

- Average
- Standard deviation
- Difference between the maximum and minimum values

To retrieve the results of statistical analysis, use the following command:

- :CALC{1-4}:MARK:MATH:STAT:DATA? on page 258

Also, you can use the following command to control whether to display the results of statistical analysis on the LCD:

- :CALC{1-4}:MARK:MATH:STAT on page 257

NOTE

You can retrieve the results of statistical analysis even after you have turned off the display of the results of statistical analysis.

Alternatively, you can use the analysis command to analyze the trace statistics. When you use the analysis command, you can analyze the trace data in a specific range as well as the trace data throughout the entire sweep range. For information how to use the analysis command, refer to “Using the Analysis Command” on page 91.

Analyzing impedance

By turning on the parameter conversion function, you can convert the measurement result of the S parameter to the following parameters.

- Equivalent impedance in reflection measurement
- Equivalent impedance in transmission measurement
- Equivalent admittance in reflection measurement
- Equivalent admittance in transmission measurement
- Inverse of S-parameter (1/S)

To turn ON/OFF the parameter conversion function, use the following command:

- :CALC{1-4}:CONV on page 209

To select the parameter to which you want to convert the measurement result, use the following command:

- :CALC{1-4}:CONV:FUNC on page 210

7

Reading/Writing Measurement Data

This chapter provides an overview of the Agilent E5061A/E5062A's internal data processing flow and describes how to read and write measurement results (internal data array).

Data Transfer Format

When you transfer data using the one of the following commands, you can choose among ASCII transfer format, IEEE 64-bit floating point binary transfer format and IEEE 32-bit floating point binary transfer format.

NOTE

The instrument always uses the ASCII transfer format when you transfer data without using any of the following commands.

- :CALC{1-4}:DATA:FDAT on page 213
- :CALC{1-4}:DATA:FMEM on page 214
- :CALC{1-4}:DATA:SDAT on page 215
- :CALC{1-4}:DATA:SMEM on page 216
- :CALC{1-4}:FUNC:DATA? on page 219
- :CALC{1-4}:LIM:DATA on page 231
- :CALC{1-4}:LIM:REP? on page 240
- :SENS{1-4}:FREQ:DATA? on page 414
- :SENS{1-4}:SEGM:DATA on page 419

To set the data transfer format, use the following command:

- :FORM:DATA on page 336

NOTE

Executing the :SYST:PRES command on page 477 or *RST command on page 197 does not affect the current setting of the data transfer format.

ASCII Transfer Format

When you select the ASCII transfer format as the data transfer format, numbers are transferred as ASCII bytes, each of which corresponds to one of the formats shown below. Note that numbers are separated from one another with a comma (,) in accordance with the IEEE 488.2 specification.

NOTE

Numeric data strings vary in length. Keep this in mind when you extract some data from retrieved numeric data strings in your program.

- Integer format

Figure 7-1 shows this format. Numbers are expressed as integers. For example, 201 is expressed as “+201” or “201.”

Figure 7-1

Integer format

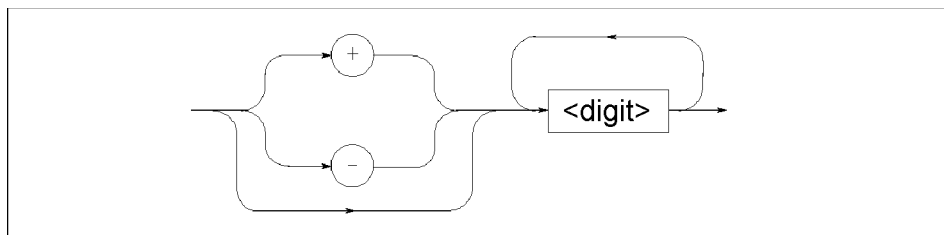

lb005013e

- Floating-point number format

Figure 7-2 shows this format. Numbers are expressed with floating points. For example, 1000 is expressed as “+1.0000000000+003”.

Figure 7-2

Floating-point number format

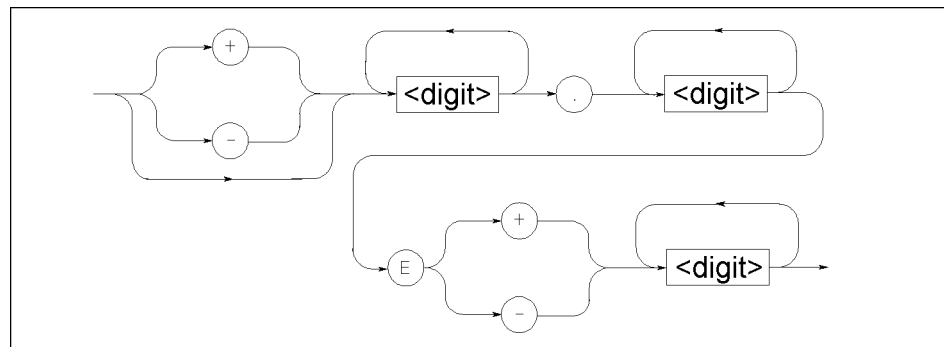

lb005015e

Binary Transfer Format

You can select the binary transfer format from the IEEE 64-bit floating point format or the IEEE 32-bit floating point format depending on the controller you use.

IEEE 64-bit floating point format

When you select the IEEE 64-bit floating point binary transfer format as the data transfer format, numbers are transferred in the format shown in Figure 7-3.

Figure 7-3

Binary transfer format

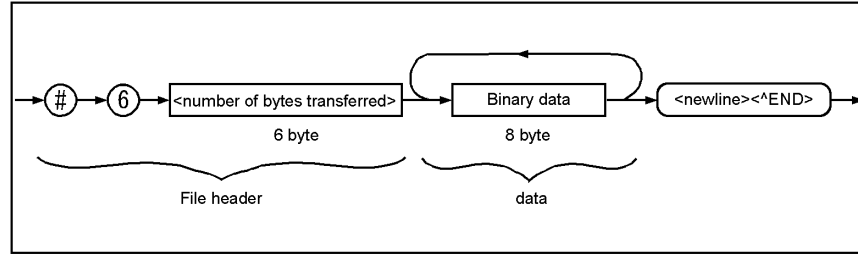

4287ape024

This data transfer format uses a header that consists of a sharp character (#), a number of 6 (which indicates the byte size of the <number of bytes transferred> part), and the <number of bytes transferred> part in this order. The header is followed by the binary data (each number consists of 8 bytes and the total is the byte size indicated by <number of bytes transferred>) and the message terminator <new line>^END.

The binary data is expressed in the IEEE 754 64-bit floating-point number format shown in Figure 7-4.

Figure 7-4

64-bit floating point format

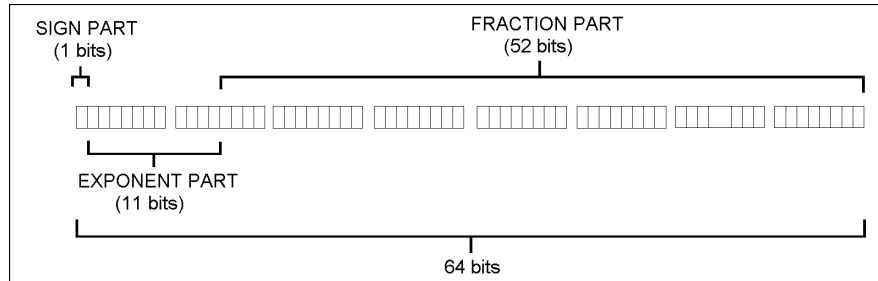

4287ape025

IEEE 32-bit floating point format

When you select the IEEE 32-bit floating point binary transfer format as the data transfer format, numbers are transferred in the format shown in Figure 7-5.

Figure 7-5

IEEE 32-bit floating point binary transfer format

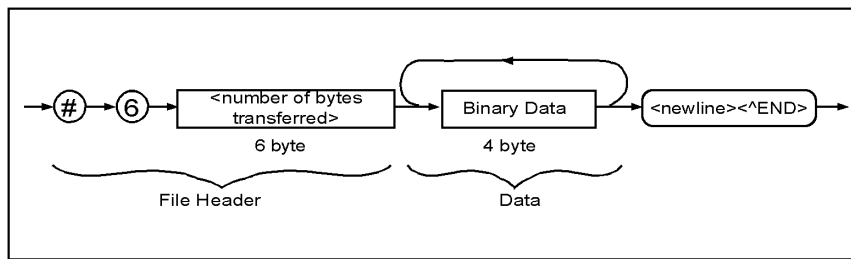

e5070bpe032

This data transfer format uses a header that consists of a sharp character (#), a number of 6 (which indicates the byte size of the <number of bytes transferred> part), and the <number of bytes transferred> part in this order. The header is followed by the binary data (each number consists of 4 bytes and the total is the byte size indicated by <number of bytes transferred>) and the message terminator <newline>^END.

The binary data is expressed in the IEEE 754 32-bit floating-point number format shown in Figure 7-6.

Figure 7-6

32-bit floating point data

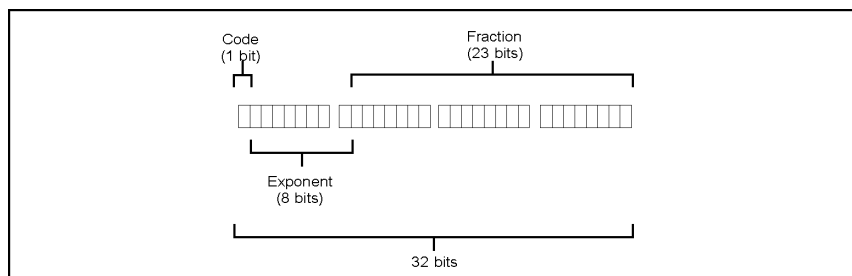

e5070bpe033

Byte order

When you opt to perform binary transfer, you can configure the instrument to transfer the bytes of the data in one of the following two byte orders:

- NORMAL Transfer begins with the byte that contains the MSB (most significant bit); that is, the leftmost byte in Figure 7-4 and Figure 7-6.
- SWAPped Transfer begins with the byte that contains the LSB (least significant bit); that is, the rightmost byte in Figure 7-4 and Figure 7-6.

To set the byte order, use the following command:

- :FORM:BORD on page 335

NOTE

Executing the :SYST:PRES command on page 477 or *RST command on page 197 does not affect the current setting of the byte order.

Internal data processing

Data flow

Figure 7-7 provides an overview of the E5061A/E5062A's internal data processing flow. For more information on the data processing flow, refer to "User's Guide."

Figure 7-7

E5061A/E5062A's data processing flow

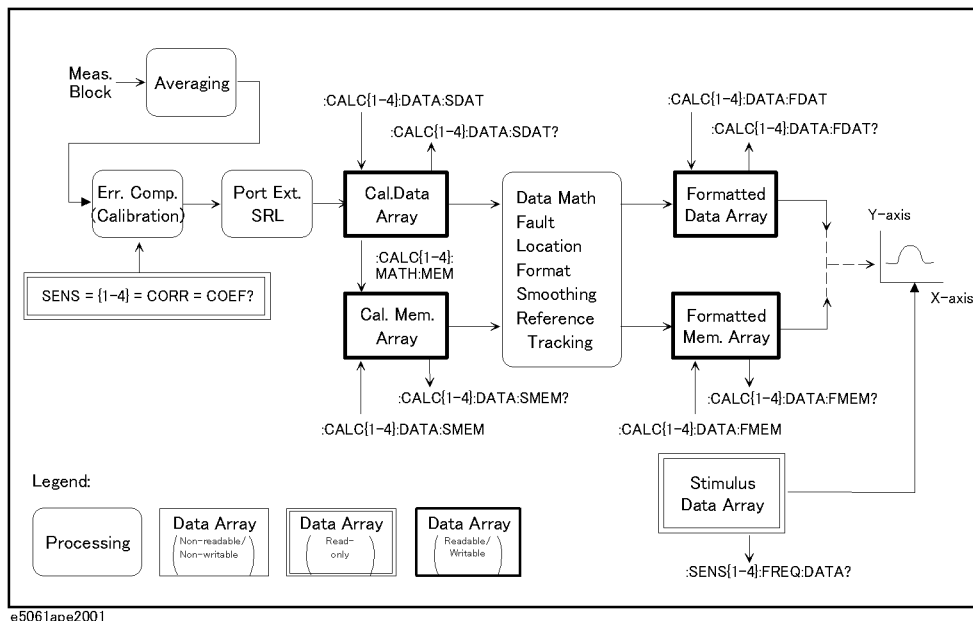

Internal data arrays

Corrected data arrays

A corrected data array contains the corrected data obtained by performing error correction, port extension compensation (calibration), Fixture Simulator operations on the raw measured data of S parameter specified for each trace of each channel. Each data element is stored as a complex number (Re/Im).

The instrument retains 16 corrected data arrays at maximum, each of which is associated with one of the 4 traces contained in one of the 4 channels $4 \times 4 = 16$). To read/write one of the corrected data arrays, use the following command:

- `:CALC{1-4}:DATA:SDAT` on page 215

Corrected memory arrays

When the `:CALC{1-4}:MATH:MEM` command on page 279 command is executed on a particular corrected data array, its copy is stored into the corrected memory array corresponding to that corrected data array.

The instrument retains 16 corrected memory arrays at maximum, each of which is

associated with one of the 4 traces contained in one of the 4 channels $4 \times 4 = 16$). To read/write one of the corrected data arrays, use the following command:

- :CALC{1-4}:DATA:SMEM on page 216

Formatted data array

A formatted data array contains the formatted data (values to be displayed) obtained by performing data math operations, measurement parameter conversion, and smoothing on a particular corrected data array. Regardless of the data format, it contains two data elements per measurement point as shown in the following table:

Table 7-1

Data elements and data formats

Data format *1	Data element (primary value)	Data element (secondary value)
log magnitude	log magnitude	Always 0
Phase	Phase	Always 0
Group delay	Group delay	Always 0
Smith chart (Lin)	Liner magnitude	Phase
Smith chart (Log)	log magnitude	Phase
Smith chart (Re/Im)	Real part of a complex number	Imaginary part of a complex number
Smith chart (R+jX)	Resistance	Reactance
Smith chart (G+jB)	Conductance	Susceptance
Polar (Lin)	Liner magnitude	Phase
Polar (Log)	log magnitude	Phase
Polar (Re/Im)	Real part of a complex number	Imaginary part of a complex number
Liner magnitude	Liner magnitude	Always 0
SWR	SWR	Always 0
Real number	Real part of a complex number	Always 0
Imaginary number	Imaginary part of a complex number	Always 0
Expanded phase	Expanded phase	Always 0
Positive phase	Positive phase	Always 0

*1. To set this, use the :CALC{1-4}:FORM command on page 217 command.

The instrument retains 16 formatted data arrays at maximum, each of which is associated with one of the 4 traces contained in one of the 4 channels $4 \times 4 = 16$). To read/write one of the formatted data arrays, use the following command:

- :CALC{1-4}:DATA:FDAT on page 213

Formatted memory arrays

A formatted memory array contains the formatted data (values to be displayed) obtained by performing data math operations, measurement parameter conversion, and smoothing on a particular corrected memory array.

The instrument retains 16 formatted memory arrays at maximum, each of which is associated with one of the 4 traces contained in one of the 4 channels $4 \times 4 = 16$). To read/write one of the formatted memory arrays, use the following command:

- :CALC{1-4}:DATA:FMEM on page 214

Stimulus data arrays

A stimulus data array contains the stimulus values for all measurement points.

The instrument retains 4 stimulus data arrays at maximum, each of which is associated with one of the 4 channels. Stimulus data arrays are read-only. To retrieve one of the stimulus data arrays, use the following command:

- :SENS{1-4}:FREQ:DATA? on page 414

Calibration coefficient arrays

A calibration coefficient array contains the calibration coefficients calculated based on the results of measurement performed with standard devices.

The instrument retains 4 calibration coefficient arrays at maximum, each of which is associated with one of the 4 channels. No commands are available that read or write calibration coefficient arrays.

Retrieving Measurement Results

“Internal data arrays” on page 106 allow you to retrieve all measurement results throughout a particular trace. Alternatively, markers allow you to retrieve measurement results at your specified points. For information on how to retrieve marker values, refer to “Retrieving Measurement Results at Marker Positions” on page 88.

Retrieving Internal Data Arrays

You can choose between the ASCII and binary data transfer formats when you retrieve internal data arrays. For more information, refer to “Data Transfer Format” on page 102.

Example 7-1 and Example 7-2 show sample programs that demonstrate how to retrieve formatted data arrays. The sample program in Example 7-1 uses the ASCII transfer format while the sample in Example 7-2 uses the binary transfer format. You can find the source files of these programs, named `read_asc.htb` and `read_bin.htb`, on the sample program disk.

Each of the sample programs holds the sweep on channel 1, then retrieves and displays the stimulus array for channel 1 and the formatted data array for trace 1.

The program in Example 7-1 is described in detail below:

Line 50	Assigns a GPIB address to the I/O pass.
Lines 70 to 90	These lines set channel 1's active trace to trace 1 and hold the sweep.
Lines 100 to 110	These lines retrieve the number of points in channel 1 and stores that number into the Nop variable.
Line 120	Resizes the Fdata and Freq arrays based on the value of the Nop variable (the number of points).
Line 160	Sets the data transfer format to ASCII.
Lines 180 to 190	These lines retrieve the formatted data array for the active trace (trace 1) in channel 1, and store the data into the Fdata array.
Lines 200 to 210	These lines retrieve the stimulus array for channel 1 and stores the data into the Freq variable.
Lines 250 to 260	These lines retrieve the data format for the active trace (trace 1) in channel 1, and store it into the Fmt\$ array.
Lines 270 to 400	The lines display each point along with one measured value and a frequency if the Fmt\$ is “MLOG”, “PHAS”, “GDEL”, “MLIN”, “SWR”, “REAL”, “IMAG”, or “UPH”; or along with two measured values and a frequency if Fmt\$ returns any other string.

Example 7-1

Using the ASCII Transfer Format to Retrieve Internal Data Arrays (read_asc.htb)

```
10     REAL Fdata (1:1601,1:2), Freq(1:1601)
20     DIM Img$(30)
30     INTEGER Nop, I
40     !
50     ASSIGN @Agte507x TO 717
60     !
70     OUTPUT @Agte507x; ":CALC1:PAR1:SEL"
80     OUTPUT @Agte507x; ":INIT1:CONT OFF"
90     OUTPUT @Agte507x; ":ABOR"
100    OUTPUT @Agte507x; ":SENS1:SWE:POIN?"
110    ENTER @Agte507x; Nop
120    REDIM Fdata (1:Nop,1:2), Freq(1:Nop)
130    !
140    ! Reading out in ASCII transfer format
150    !
160    OUTPUT @Agte507x; ":FORM:DATA ASC"
170    !
180    OUTPUT @Agte507x; ":CALC1:DATA:FDAT?"
190    ENTER @Agte507x; Fdata (*)
200    OUTPUT @Agte507x; ":SENS1:FREQ:DATA?"
210    ENTER @Agte507x; Freq (*)
220    !
230    ! Displaying
240    !
250    OUTPUT @Agte507x; ":CALC1:FORM?"
260    ENTER @Agte507x; Fmt$
270    SELECT Fmt$
280        CASE "MLOG", "PHAS", "GDEL", "MLIN", "SWR", "REAL", "IMAG", "UPH"
290            Img$="MD.4DE,2X,MD.6DE"
300            PRINT " Frequency      Data"
310            FOR I=1 TO Nop
320                PRINT USING Img$; Freq(I), Fdata(I,1)
330            NEXT I
340        CASE ELSE
350            Img$="MD.4DE,2X,MD.6DE,2X,MD.6DE"
360            PRINT " Frequency      Data1      Data2"
370            FOR I=1 TO Nop
380                PRINT USING Img$; Freq(I), Fdata(I,1), Fdata(I,2)
390            NEXT I
400    END SELECT
410    !
420    END
```

The program in Example 7-2 is described in detail below:

Lines 50 to 60	Assigns a GPIB address to the I/O pass.
Lines 80 to 100	These lines set channel 1's active trace to trace 1 and hold the sweep.
Lines 110 to 120	These lines retrieve the number of points in channel 1 and store that number into the Nop variable.
Line 130	Resizes the Fdata and Freq arrays based on the value of the Nop variable (the number of points).
Line 170	Sets the data transfer format to binary.
Lines 190 to 200	These lines retrieve the data header.
Line 210	Retrieves the formatted data array for the active trace (trace 1) in channel 1, and stores the data into the Fdata array.

NOTE

Because binary data must be read without being formatted, the program uses an I/O path (@Binary) that is configured to support the retrieval of unformatted data. This applies to line 250 as well.

Line 220	Reads the message terminator at the end of the data.
Lines 230 to 240	These lines retrieve the data header.
Line 250	Retrieves the stimulus array for channel 1 and stores the data into the Freq variable.
Line 260	Reads the message terminator at the end of the data.
Lines 300 to 310	These lines retrieve the data format for the active trace (trace 1) in channel 1, and store it into the Fmt\$ array.
Lines 320 to 450	The lines display each point along with one measured value and a frequency if the Fmt\$ is "MLOG", "PHAS", "GDEL", "MLIN", "SWR", "REAL", "IMAG", or "UPH"; or along with two measured values and a frequency if Fmt\$ returns any other string.

Example 7-2

Using the Binary Transfer Format to Retrieve Internal Data Arrays (read_bin.htb)

```
10     REAL Fdata (1:1601,1:2), Freq(1:1601)
20     DIM Buff$(9), Img$(30)
30     INTEGER Nop, I
40     !
50     ASSIGN @Agte507x TO 717
60     ASSIGN @Binary TO 717;FORMAT OFF
70     !
80     OUTPUT @Agte507x;":CALC1:PAR1:SEL"
90     OUTPUT @Agte507x;":INIT1:CONT OFF"
100    OUTPUT @Agte507x;":ABOR"
110    OUTPUT @Agte507x;":SENS1:SWE:POIN?"
120    ENTER @Agte507x;Nop
130    REDIM Fdata (1:Nop,1:2), Freq(1:Nop)
140    !
150    ! Reading out in binary transfer format
160    !
170    OUTPUT @Agte507x;":FORM:DATA REAL"
180    !
190    OUTPUT @Agte507x;":CALC1:DATA:FDAT?"
200    ENTER @Agte507x USING "#,8A";Buff$
210    ENTER @Binary;Fdata(*)
220    ENTER @Agte507x USING "#,1A";Buff$
230    OUTPUT @Agte507x;":SENS1:FREQ:DATA?"
240    ENTER @Agte507x USING "#,8A";Buff$
250    ENTER @Binary;Freq(*)
260    ENTER @Agte507x USING "#,1A";Buff$
270    !
280    ! Displaying
290    !
300    OUTPUT @Agte507x;":CALC1:FORM?"
310    ENTER @Agte507x;Fmt$
320    SELECT Fmt$
330        CASE "MLOG", "PHAS", "GDEL", "MLIN", "SWR", "REAL", "IMAG", "UPH"
340            Img$="MD.4DE,2X,MD.6DE"
350            PRINT " Frequency      Data"
360            FOR I=1 TO Nop
370                PRINT USING Img$;Freq(I), Fdata(I,1)
380            NEXT I
390        CASE ELSE
400            Img$="MD.4DE,2X,MD.6DE,2X,MD.6DE"
410            PRINT " Frequency      Data1      Data2"
420            FOR I=1 TO Nop
430                PRINT USING Img$;Freq(I), Fdata(I,1), Fdata(I,2)
440            NEXT I
450    END SELECT
460    !
470    END
```

Entering Data into a Trace

You can change the data/memory trace on the LCD by writing the new data into the “Formatted data array” on page 107/“Formatted memory arrays” on page 108.

When you write data into formatted data/memory array, you can choose either the ASCII or binary transfer format (see “Data Transfer Format” on page 102).

Example 7-3 and Example 7-4 show sample programs that demonstrate how to write data into formatted data arrays. The sample program in Example 7-3 uses the ASCII transfer format while the sample in Example 7-4 uses the binary transfer format. You can find the source files of these programs, named write_a.htb and write_b.htb, on the sample program disk.

Each of the sample programs holds the sweep on channel 1, retrieves the data from a specified file (a file saved measurement data using the :MMEM:STOR:FDAT command on page 354 command), and populates trace 1 for channel 1 with the retrieved data.

The program in Example 7-3 is described in detail below:

- Line 50 Assigns a GPIB address to the I/O pass.
- Line 70 Passes control to a subprogram named Inp_file_name, which lets the user input a file name, and then stores the returned file name into the File\$ variable. For more information on the Inp_file_name subprogram, refer to the description in Example 7-4.
- Lines 90 to 110 These lines set channel 1's active trace to trace 1 and hold the sweep.
- Lines 130 to 140 These lines retrieve the number of points in channel 1 and stores that number into the Nop variable.
- Line 150 Resizes the Fdata array based on the value of the Nop variable (the number of points).
- Line 170 This line points to the statement block to be executed if an error occurs in retrieving data from the file (for example, if no file matches File\$).
- Lines 180 to 260 These lines retrieve the formatted data from the file identified by File\$, and store the data into the Fdata array.
- Line 280 Sets the data transfer format to ASCII.
- Line 300 Writes Fdata into the formatted data array for the active trace (trace 1) in channel 1.
- Lines 340 to 380 This statement block is executed if an error occurs in retrieving data from the file.

Reading/Writing Measurement Data Entering Data into a Trace

Example 7-3

Using the ASCII Transfer Format to Write Formatted Data Arrays (write_a.htb)

```
10 REAL Freq,Fdata(1:1601,1:2)
20 DIM File$(300)
30 INTEGER Nop
40 !
50 ASSIGN @Agte507x TO 717
60 !
70 CALL Inp_file_name(File$)
80 !
90 OUTPUT @Agte507x;":CALC1:PAR1:SEL"
100 OUTPUT @Agte507x;":INIT1:CONT OFF"
110 OUTPUT @Agte507x;":ABOR"
120 !
130 OUTPUT @Agte507x;":SENS1:SWE:POIN?"
140 ENTER @Agte507x;Nop
150 REDIM Fdata(1:Nop,1:2)
160 !
170 ON ERROR GOTO File_error
180 ASSIGN @File TO File$
190 ENTER @File USING "K";Buff$
200 ENTER @File USING "K";Buff$
210 ENTER @File USING "K";Buff$
220 FOR I=1 TO Nop
230 ENTER @File USING "19D,2X,19D,2X,19D";Freq,Fdata(I,1),Fdata
(I,2)
240 NEXT I
250 ASSIGN @File TO *
260 OFF ERROR
270 !
280 OUTPUT @Agte507x;":FORM:DATA ASC"
290 !
300 OUTPUT @Agte507x;":CALC1:DATA:FDAT ";Fdata(*)
310 !
320 GOTO Prog_end
330 !
340 File_error: OFF ERROR
350 PRINT "##### ERROR #####"
360 PRINT File$&" is NOT exist."
370 PRINT " or"
380 PRINT File$&" has UNSUITABLE data."
390 !
400 Prog_end: END
410 !=====
420 ! File Name Input Function
430 !=====
440 SUB Inp_file_name(Inp_name$)
450 DIM Inp_char$(9)
460 ON ERROR GOTO Inp_start
470 Inp_start: !
480 PRINT "Input File Name!"
490 INPUT "Name?",Inp_name$
500 PRINT "Input Name: "&Inp_name$
510 INPUT "OK? [Y/N]",Inp_char$
520 IF UPC$(Inp_char$)<>"Y" THEN Inp_start
530 OFF ERROR
540 SUBEND
```

The program in Example 7-4 is described in detail below:

Lines 50 to 60	Assigns a GPIB address to the I/O pass.
Line 70	Passes control to a subprogram named <code>Inp_file_name</code> , which lets the user input a file name, and then stores the returned file name into the <code>File\$</code> variable.
Lines 90 to 110	These lines set channel 1's active trace to trace 1 and hold the sweep.
Lines 130 to 140	These lines retrieve the number of points in channel 1 and stores that number into the <code>Nop</code> variable.
Line 150	Resizes the <code>Fdata</code> array based on the value of the <code>Nop</code> variable (the number of points).
Line 170	This line points to the statement block to be executed if an error occurs in retrieving data from the file (for example, if no file matches <code>File\$</code>).
Lines 180 to 260	These lines retrieve the formatted data from the file identified by <code>File\$</code> , and store the data into the <code>Fdata</code> array.
Line 280	Sets the data transfer format to binary.
Line 290	Creates the data header and stores it into the <code>Header\$</code> variable.
Line 300	Sends the command that writes data into the formatted data array for the active trace (trace 1) in channel 1, following it with the data header (<code>Header\$</code>).
Line 310	Sends the data itself (<code>Fdata</code>), following it with a message terminator.

NOTE

Because binary data must be written without being formatted, the program uses an I/O path (`@Binary`) that is configured to support writing unformatted data.

Lines 340 to 380 This statement block is executed if an error occurs in retrieving data from the file.

The `Inp_file_name` subprogram in lines 440 to 540, which is used to enter a save filename, is described below.

Line 460	Allows the user to return to the entry start line and re-enter the data if an error (such as an invalid entry) occurs while entering the target file name.
Lines 480 to 490	These lines prompt the user to enter the target file name. The program does not continue till the user actually enters the file name.
Lines 500 to 510	These lines display the entered file name and waits for a confirmation entry (y/n key).
Line 520	Returns to the entry start line if the key the user pressed in line 870 is not the y key.

Reading/Writing Measurement Data Entering Data into a Trace

Example 7-4

Using the Binary Transfer Format to Write Formatted Data Arrays (write_b.htb)

```
10 REAL Freq,Fdata(1:1601,1:2)
20 DIM File$(300),Header$(10)
30 INTEGER Nop
40 !
50 ASSIGN @Agte507x TO 717
60 ASSIGN @Binary TO 717;FORMAT OFF
70 CALL Inp_file_name(File$)
80 !
90 OUTPUT @Agte507x;":CALC1:PAR1:SEL"
100 OUTPUT @Agte507x;":INIT1:CONT OFF"
110 OUTPUT @Agte507x;":ABOR"
120 !
130 OUTPUT @Agte507x;":SENS1:SWE:POIN?"
140 ENTER @Agte507x;Nop
150 REDIM Fdata(1:Nop,1:2)
160 !
170 ON ERROR GOTO File_error
180 ASSIGN @File TO File$
190 ENTER @File USING "K";Buff$
200 ENTER @File USING "K";Buff$
210 ENTER @File USING "K";Buff$
220 FOR I=1 TO Nop
230 ENTER @File USING "19D,2X,19D,2X,19D";Freq,Fdata(I,1),Fdata
(I,2)
240 NEXT I
250 ASSIGN @File TO *
260 OFF ERROR
270 !
280 OUTPUT @Agte507x;":FORM:DATA REAL"
290 Header$="#6"&IVAL$(8*2*Nop,10)
300 OUTPUT @Agte507x;":CALC1:DATA:FDAT ";Header$;
310 OUTPUT @Binary;Fdata(*),END
320 GOTO Prog_end
330 !
340 File_error: OFF ERROR
350 PRINT "##### ERROR #####"
360 PRINT File$&" is NOT exist."
370 PRINT " or"
380 PRINT File$&" has UNSUITABLE data."
390 !
400 Prog_end: END
410 !=====
420 ! File Name Input Function
430 !=====
440 SUB Inp_file_name(Inp_name$)
450 DIM Inp_char$(9)
460 ON ERROR GOTO Inp_start
470 Inp_start: !
480 PRINT "Input File Name!"
490 INPUT "Name?",Inp_name$
500 PRINT "Input Name: "&Inp_name$
510 INPUT "OK? [Y/N]",Inp_char$
520 IF UPC$(Inp_char$)<>"Y" THEN Inp_start
530 OFF ERROR
540 SUBEND
```

8 Limit Test

This chapter describes how to use the Limit Test feature to perform a limit test and determine the pass/fail status of the measured data.

Performing a Limit Test

Configuring Limit Lines

The Limit Test feature of the E5061A/E5062A allows you to create up to 100 upper/lower limit lines on each trace and then determine the pass/fail status of the measured data.

When you manually configure limit lines, you must add each segment (limit line) to the limit table, and define various conditions that apply to the specific segment. On the other hand, when you use an external controller to configure limit lines, you can use the following command to define all the segment conditions (all limit lines) in the active table trace at once.

- :CALC{1-4}:LIM:DATA on page 231

Alternatively, you can configure limit lines based on the data contained in a CSV file by issuing the following command:

- :MMEM:LOAD:LIM on page 346

Also, you can save the contents of the current limit table to a file by issuing the following command:

- :MMEM:STOR:LIM on page 356

Showing/Hiding Limit Lines

To turn on or off limit lines, use the following command:

- :CALC{1-4}:LIM:DISP on page 233

Even when limit lines are hidden, the system performs limit test if the Limit Test feature is on.

To show or hide the part that is not used for evaluation, use the following command:

- :CALC{1-4}:LIM:DISP:CLIP on page 234

Turning On or Off the Limit Test Feature

To turn on or off the Limit Test feature, use the following command:

- :CALC{1-4}:LIM on page 230

Showing/Hiding “Fail”

To turn on or off the “Fail” which is displayed at the center of the window when the test result for the channel is “fail,” use the following command:

- :DISP:FSIG on page 311

Obtaining Test Results

You can obtain the test results by issuing a result retrieval command or through the status register. For detailed information on the status register, see Appendix B, “Status Reporting System.”

Test Results at Each Measurement Point

Using Commands That Retrieve Test Results

You can obtain the test results at each measurement point by retrieving the stimulus value at failed measurement points. To retrieve failed measurement points, use the following command:

Stimulus value	:CALC{1-4}:LIM:REP? on page 240
Number of measurement points	:CALC{1-4}:LIM:REP:POIN? on page 240

Using the Status Register

You cannot use the status register to obtain the test results at each measurement point.

Test Results for Each Trace

Using Commands That Retrieve Test Results

You can retrieve the test result for each trace (i.e., the trace-wide result that combines the results for all measurement points in a particular trace) by issuing the following command:

- :CALC{1-4}:LIM:FAIL? on page 235

Using the Status Register

The condition register and event register under the questionable limit channel {1-4} status register provide fourteen bits that correspond to traces 1 to 4 and contain the test results (0:Pass, 1:Fail) for the respective traces; for example, you can obtain the test result for trace 1 from bit 1, and that for trace 4 from bit 4.

Every bit of the condition register is set to 0 when a measurement cycle is started. Upon completion of measurement, those bits that correspond to failed traces are set to 1.

If the corresponding bit of the positive transition filter sets to 1 (preset value), each bit of the event register is set to 1 when the corresponding bit of the condition register changes from 0 to 1 (indicating that the corresponding trace failed the test).

Limit Test

Obtaining Test Results

To retrieve the registers, use the following command:

Questionable limit channel{1-16} status register	
Condition register	:STAT:QUES:LIM:CHAN{1-4}:COND? on page 453
Event register	:STAT:QUES:LIM:CHAN{1-4}? on page 453

Test Results for Each Channel

Using Commands That Retrieve Test Results

No commands are available that allow you to directly retrieve the test result for each channel (i.e., the channel-wide result that combines the results for all traces in a particular channel).

Using the Status Register

The questionable limit status event register provides fourteen bits that correspond to channels 1 to 4 and contain the test results (0:Pass, 1:Fail) for the respective channels; for example, you can obtain the test result for channel 1 from bit 1, and that for channel 4 from bit 4. .

Every bit of the condition register is set to 0 after the event registers are cleared by *CLS command on page 194. Upon completion of measurement, if the channel-wide test result that combines the results for all traces^{*1} in a channel is “fail”, the corresponding bit of the condition register is set to 1.

If the corresponding bit of the positive transition filter sets to 1 (preset value), every bit of the event register is set to 1 when the corresponding bit of the condition register changes from 0 to 1.

To retrieve the registers, use the following command:

Questionable limit status register	
Condition register	:STAT:QUES:LIM:COND? on page 457
Event register	:STAT:QUES:LIM? on page 453

*1. This is when the registers are set as preset values. You can configure the enable registers and transition filters under the questionable limit channel {1-16} status register so that the condition register's bits reflect the result that combines the results for a limited set of traces, rather than for all the traces.

Figure 8-1

Obtaining the test results for a channel (channel 1 in this example) using the status register

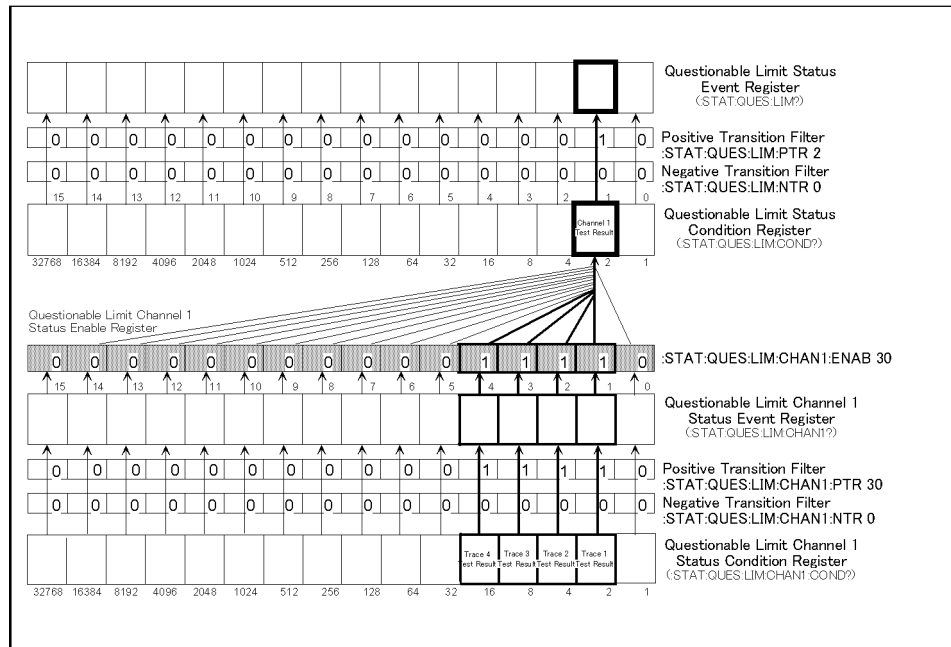

e5061ape0403

Limit Test
Obtaining Test Results

Overall Test Result

Using Commands That Retrieve Test Results

No commands are available that allow you to directly retrieve the overall test result that combine the test results for all channels.

Using the Status Register

Each of the condition register and event register under the questionable status event register provides bit 10, from which you can obtain the overall test result (0:Pass, 1:Fail).

The condition register's bit 10 is set to 0 after the event registers are cleared by *CLS command on page 194. Upon completion of measurement, this bit is set to 1 if the overall test result that combines the results for all channels*¹ is “fail”.

If the positive transition filter’s bit 10 sets to 1 (preset value), the event register’s bit 10 is set to 1 when the condition register's bit 10 changes from 0 to 1.

To retrieve the condition register and event register under the questionable status register, use the following command:

Condition register	:STAT:QUES:COND? on page 451
Event register	:STAT:QUES? on page 443

Figure 8-2

Obtaining the overall test result using the status register

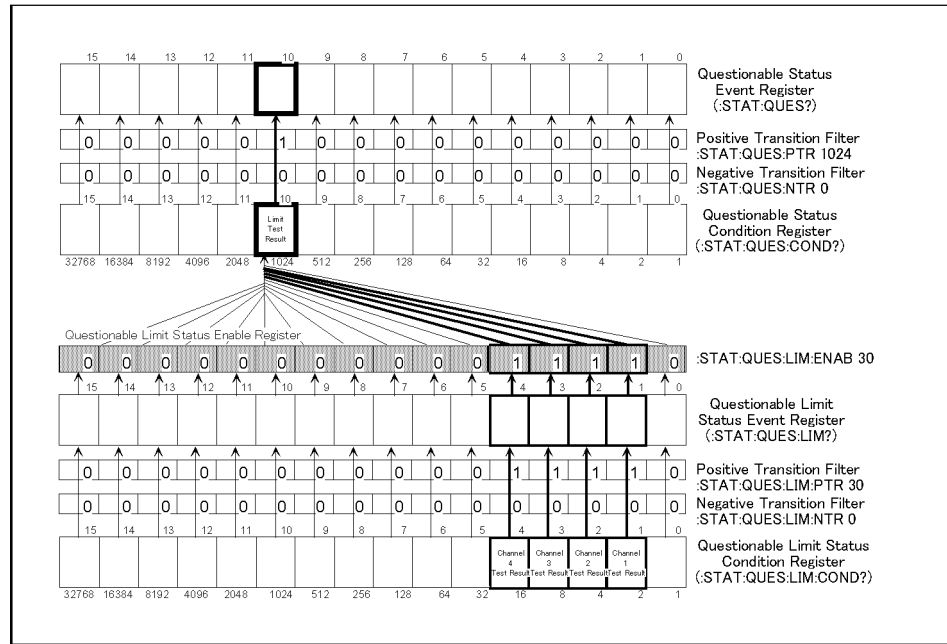

e5061ape0404

*1. This is when the registers are set as preset values. You can configure the enable registers and transition filters under the questionable limit status register so that the condition register's bit 10 reflects the result that combines the results for a limited set of channels, rather than for all the channels.

Sample Program

Example 8-1 shows a sample program that demonstrates how to perform limit tests. You can find the source file of this program, named `lim_test.htb`, on the sample program disk.

The sample program creates a limit table as shown in Table 8-1 and Table 8-2; turns on the Limit Test feature; performs one cycle of measurement; then displays the test results.

Table 8-1

Limit table for trace 1

No.	Type	Begin Stimulus	End Stimulus	Begin Response	End Response
1	MAX	847.5 MHz	905.0 MHz	-55.0 dB	-55.0 dB
2	MIN	935.0 MHz	960.0 MHz	-3.5 dB	-3.5 dB
3	MAX	935.0 MHz	960.0 MHz	0 dB	0 dB
4	MAX	980.0 MHz	1047.5 MHz	-25.0 dB	-25.0 dB

Table 8-2

Limit table for trace 2

No.	Type	Begin Stimulus	End Stimulus	Begin Response	End Response
1	MAX	847.5 MHz	925.0 MHz	0 dB	0 dB
2	MIN	935.0 MHz	960.0 MHz	-9.5 dB	-9.5 dB
3	MAX	970.0 MHz	1047.5 MHz	0 dB	0 dB

The program is described in detail below:

- Line 50 Assigns a GPIB address to the I/O pass.
- Lines 70 to 120 These lines store the sweep center value, sweep span value, trace 1 measurement parameter, trace 2 measurement parameter, trace 1 data format, and trace 2 data format into the variables `Cent`, `Span`, `Param1$`, `Param2$`, `Fmt1$`, and `Fmt2$`, respectively.
- Line 150 Stores the number of segments in trace 1 limit table into the `Num_of_seg1` variable.
- Lines 160 to 390 These lines store the settings in trace 1 limit table into the `Lim1(*)` variable.
- Line 410 Stores the number of segments in trace 2 limit table into the `Num_of_seg2` variable.
- Lines 420 to 590 These lines store the settings in trace 2 limit table into the `Lim2(*)` variable.
- Lines 610 to 620 These lines configure the sweep range for channel 1's sweep range using the center and span values contained in the `Cent` and `Span` values.
- Lines 630 to 660 These lines configure channel 1 so that it contains 2 traces, displays graphs in two windows tiled horizontally (i.e., with the screen split into the upper and lower halves), uses a bus trigger source, and works in continuous activation mode.

Limit Test Sample Program

Line 700	Sets channel 1's active trace to trace 1.
Lines 720 to 730	These lines store trace 1's measurement parameter and data format into the variables Param1\$ and Fmt1\$, respectively.
Lines 750 to 810	These lines set up the limit table for trace 1. Line 750: Sends the command that sets up a limit table along with the Num_of_seg1 variable that contains the number of segments. Lines 770 to 790: Sends five data items (type, start point stimulus value, end point stimulus value, start point response value, and end point response value) for each segment.
Lines 820 to 830	These lines turns on the display of limit lines and the Limit Test feature for trace 1.
Line 870	Sets channel 1's active trace to trace 2.
Lines 890 to 900	These lines set trace 2's measurement parameter and data format to Param2\$ and Fmt2\$, respectively.
Lines 920 to 980	These lines set up the limit table for trace 2.
Lines 990 to 1000	These lines turns on the display of limit lines and the Limit Test feature for trace 2.
Lines 1040 to 1060	These lines set, under the questionable limit channel 1 status register, the enable register and positive transition filter to 6 (000000000000110 in binary notation) while setting the negative transition filter to 0 so that the questionable limit status condition register's bit 1 is set to 1 when the test result that combines the results for trace 1 and trace 2 is "fail".

NOTE

The sample program provides an example of explicitly configuring the register bits so that they reflect the test result that only covers trace 1 and trace 2. However, because the results for traces 3 to 9 will never be "fail" as long as the Limit Test feature is disabled for those traces, the register bits would reflect the test result that is limited to traces 1 and 2 even if you did not change the default setting.

Lines 1070 to 1080	These lines set transition filters so that the questionable limit status event register's bit 1 is set to 1 when the questionable limit status condition register's bit 1 changes from 0 to 1.
Line 1090	Clears the questionable limit status event register and questionable limit channel 1 status event register.
Lines 1110 to 1130	These lines trigger the instrument, and waits until the sweep cycle completes.
Lines 1170 to 1190	These lines retrieve the value of the questionable limit status event register, and store the setting of bit 1 of the value into Ch1_judge.
Lines 1200 to 1230	These lines retrieve the value of the questionable limit channel 1 status event register, and store the settings of bit 1 and bit 2 of the value into Tr1_judge and Tr2_judge, respectively.
Line 1280	Displays a message indicating that the DUT has passed the limit test if the test result for channel 1 is "Pass" (i.e., if Ch1_judge returns 0).
Lines 1300 to 1660	These lines are executed if the test result for channel 1 is "Fail" (i.e., if

Ch1_judge returns 1).

Line 1300: Notifies the user that the limit test result is “Fail”.

Line 1320: Displays a message indicating that trace 1 has passed the limit test if the test result for trace 1 is “Pass” (i.e., if Tr1_judge returns 0).

Lines 1340 to 1470: These lines are executed if the test result for trace 1 is “Fail” (i.e., if Tr1_judge returns 1). The lines notify the user that the test result for trace 1 is “Fail”, then retrieve and display the frequencies at the failed measurement points on trace 1.

Line 1340: Notifies the user that the limit test result for trace 1 is “Pass”.

Line 1380: Sets channel 1's active trace to trace 2.

Lines 1390 to 1410: These lines retrieve the number of failed measurement points on trace 1 and, based on that number, resize the array that will contain retrieved frequencies.

Lines 1420 to 1470: These lines retrieve and display the frequencies at the failed measurement points on trace 1.

Line 1500: Displays a message indicating that trace 2 has passed the limit test if the test result for trace 2 is “Pass” (i.e., if Tr2_judge returns 0).

Lines 1520 to 1650: If the test result for trace 2 is “Fail” (i.e., if Tr2_judge returns 1), these lines notify the user that trace 2 has failed to pass the limit test, and then retrieve and display the frequencies at the failed measurement points on trace 2.

Limit Test Sample Program

Example 8-1

Limit Test (lim_test.hrb)

```
10 DIM Param1$[9],Param2$[9],Fmt1$[9],Fmt2$[9],Buff$[9]
20 REAL Cent,Span,Lim1(1:4,1:5),Lim2(1:3,1:5),Fail_data(1:1601)
30 INTEGER Num_of_seg1,Num_of_seg2,Segment,Column,Fail_point
40 !
50 ASSIGN @Agte507x TO 717
60 !
70 Cent=9.475E+8
80 Span=2.00E+8
90 Param1$="S21"
100 Param2$="S11"
110 Fmt1$="MLOG"
120 Fmt2$="MLOG"
130 !
140 ! == Trace 1 Limit Line ==
150 Num_of_seg1=4 ! Number of segments: 4
160 ! -- Segment 1 --
170 Lim1(1,1)=1 ! Type : Maximum
180 Lim1(1,2)=8.475E+8 ! Frequency Start: 847.5 MHz
190 Lim1(1,3)=9.050E+8 ! Stop : 905.0 MHz
200 Lim1(1,4)=-55 ! Response Start: -55 dBm
210 Lim1(1,5)=-55 ! Stop : -55 dBm
220 ! -- Segment 2 --
230 Lim1(2,1)=2 ! Type : Minimum
240 Lim1(2,2)=9.350E+8 ! Frequency Start: 935.0 MHz
250 Lim1(2,3)=9.600E+8 ! Stop : 960.0 MHz
260 Lim1(2,4)=-3.5 ! Response Start: -3.5 dBm
270 Lim1(2,5)=-3.5 ! Stop : -3.5 dBm
280 ! -- Segment 3 --
290 Lim1(3,1)=1 ! Type : Maximum
300 Lim1(3,2)=9.350E+8 ! Frequency Start: 935.0 MHz
310 Lim1(3,3)=9.600E+8 ! Stop : 960.0 MHz
320 Lim1(3,4)=0 ! Response Start: 0 dBm
330 Lim1(3,5)=0 ! Stop : 0 dBm
340 ! -- Segment 4 --
350 Lim1(4,1)=1 ! Type : Maximum
360 Lim1(4,2)=9.800E+8 ! Frequency Start: 980.0 MHz
370 Lim1(4,3)=1.0475E+9 ! Stop : 1047.5 MHz
380 Lim1(4,4)=-25 ! Response Start: -25 dBm
390 Lim1(4,5)=-25 ! Stop : -25 dBm
400 ! == Trace 2 Limit Line ==
410 Num_of_seg2=3 ! Number of segments: 3
420 ! -- Segment 1 --
430 Lim2(1,1)=1 ! Type : Maximum
440 Lim2(1,2)=8.475E+8 ! Frequency Start: 847.5 MHz
450 Lim2(1,3)=9.250E+8 ! Stop : 925.0 MHz
460 Lim2(1,4)=0 ! Response Start: 0 dBm
470 Lim2(1,5)=0 ! Stop : 0 dBm
480 ! -- Segment 2 --
490 Lim2(2,1)=1 ! Type : Maximum
500 Lim2(2,2)=9.350E+8 ! Frequency Start: 935.0 MHz
510 Lim2(2,3)=9.600E+8 ! Stop : 960.0 MHz
520 Lim2(2,4)=-9.5 ! Response Start: -9.5 dBm
530 Lim2(2,5)=-9.5 ! Stop : -9.5 dBm
540 ! -- Segment 3 --
550 Lim2(3,1)=1 ! Type : Maximum
```

```

560 Lim2(3,2)=9.700E+8      ! Frequency Start: 970.0 MHz
570 Lim2(3,3)=1.0475E+9    !                Stop : 1047.5 MHz
580 Lim2(3,4)=0            ! Response Start: 0 dBm
590 Lim2(3,5)=0            !                Stop : 0 dBm
600 !
610 OUTPUT @Agte507x;":SENS1:FREQ:CENT ";Cent
620 OUTPUT @Agte507x;":SENS1:FREQ:SPAN ";Span
630 OUTPUT @Agte507x;":CALC1:PAR1:COUN 2"
640 OUTPUT @Agte507x;":DISP:WIND1:SPL D1_2"
650 OUTPUT @Agte507x;":TRIG:SOUR BUS"
660 OUTPUT @Agte507x;":INIT1:CONT ON"
670 !
680 ! Trace 1
690 !
700 OUTPUT @Agte507x;":CALC1:PAR1:SEL"
710 !
720 OUTPUT @Agte507x;":CALC1:PAR1:DEF "&Param1$
730 OUTPUT @Agte507x;":CALC1:FORM "&Fmt1$
740 !
750 OUTPUT @Agte507x;":CALC1:LIM:DATA ";Num_of_seg1;
760 FOR Segment=1 TO Num_of_seg1
770     FOR Column=1 TO 5
780         OUTPUT @Agte507x;",";Lim1(Segment,Column);
790     NEXT Column
800 NEXT Segment
810 OUTPUT @Agte507x;""
820 OUTPUT @Agte507x;":CALC1:LIM:DISP ON"
830 OUTPUT @Agte507x;":CALC1:LIM ON"
840 !
850 ! Trace 2
860 !
870 OUTPUT @Agte507x;":CALC1:PAR2:SEL"
880 !
890 OUTPUT @Agte507x;":CALC1:PAR2:DEF "&Param2$
900 OUTPUT @Agte507x;":CALC1:FORM "&Fmt2$
910 !
920 OUTPUT @Agte507x;":CALC1:LIM:DATA ";Num_of_seg2;
930 FOR Segment=1 TO Num_of_seg2
940     FOR Column=1 TO 5
950         OUTPUT @Agte507x;",";Lim2(Segment,Column);
960     NEXT Column
970 NEXT Segment
980 OUTPUT @Agte507x;""
990 OUTPUT @Agte507x;":CALC1:LIM:DISP ON"
1000 OUTPUT @Agte507x;":CALC1:LIM ON"
1010 !
1020 ! Setting status registers
1030 !
1040 OUTPUT @Agte507x;":STAT:QUES:LIM:CHAN1:ENAB 6"
1050 OUTPUT @Agte507x;":STAT:QUES:LIM:CHAN1:PTR 6"
1060 OUTPUT @Agte507x;":STAT:QUES:LIM:CHAN1:NTR 0"
1070 OUTPUT @Agte507x;":STAT:QUES:LIM:PTR 2"
1080 OUTPUT @Agte507x;":STAT:QUES:LIM:NTR 0"
1090 OUTPUT @Agte507x;"*CLS"
1100 !
1110 OUTPUT @Agte507x;":TRIG:SING"
1120 OUTPUT @Agte507x;"*OPC?"
1130 ENTER @Agte507x;Buff$

```

Limit Test Sample Program

```
1140      !
1150      ! Checking test results
1160      !
1170      OUTPUT @Agte507x;":STAT:QUES:LIM?"
1180      ENTER @Agte507x;Reg_val
1190      Ch1_judge=BIT(Reg_val,1)
1200      OUTPUT @Agte507x;":STAT:QUES:LIM:CHAN1?"
1210      ENTER @Agte507x;Reg_val
1220      Tr1_judge=BIT(Reg_val,1)
1230      Tr2_judge=BIT(Reg_val,2)
1240      !
1250      ! Displaying test results
1260      !
1270      IF Ch1_judge=0 THEN
1280          PRINT "## PASS! ##"
1290      ELSE
1300          PRINT "## FAIL! ##"
1310          IF Tr1_judge=0 THEN
1320              PRINT " Trace1(S21): PASS"
1330          ELSE
1340              PRINT " Trace1(S21): FAIL"
1350              !
1360              ! Reading and displaying frequency at failed points
1370              !
1380              OUTPUT @Agte507x;":CALC1:PAR1:SEL"
1390              OUTPUT @Agte507x;":CALC1:LIM:REP:POIN?"
1400              ENTER @Agte507x;Fail_point
1410              REDIM Fail_data(1:Fail_point)
1420              OUTPUT @Agte507x;":CALC1:LIM:REP?"
1430              ENTER @Agte507x;Fail_data(*)
1440              PRINT " Frequency:"
1450              FOR I=1 TO Fail_point
1460                  PRINT USING "3X,MD.4DE";Fail_data(I)
1470              NEXT I
1480          END IF
1490          IF Tr2_judge=0 THEN
1500              PRINT " Trace2(S11): PASS"
1510          ELSE
1520              PRINT " Trace2(S11): FAIL"
1530              !
1540              ! Reading and displaying frequency at failed points
1550              !
1560              OUTPUT @Agte507x;":CALC1:PAR2:SEL"
1570              OUTPUT @Agte507x;":CALC1:LIM:REP:POIN?"
1580              ENTER @Agte507x;Fail_point
1590              REDIM Fail_data(1:Fail_point)
1600              OUTPUT @Agte507x;":CALC1:LIM:REP?"
1610              ENTER @Agte507x;Fail_data(*)
1620              PRINT " Frequency:"
1630              FOR I=1 TO Fail_point
1640                  PRINT USING "3X,MD.4DE";Fail_data(I)
1650              NEXT I
1660          END IF
1670      END IF
1680      END
```

9

Saving and Recalling (File Management)

This chapter describes how to save and recall instrument status and measurement results onto/from the files. Here also covered is managing files.

Saving and Recalling File

Specifying file

When running a command for saving, recalling, and managing files, use a filename with extension to specify a particular file. Specify “A:” in the beginning of the file name, when specifying a file on the flexible disk. Also, when specifying a file name with directory, use “/” (slash) or “\” (backslash) as a delimiter.

Saving and recalling instrument status

You can save the instrument state using one of the following 2 methods:

- Saving the entire instrument state into a file
- Saving the state for each channel into registers A to D (volatile memory)

Selecting content to be saved

When saving the instrument status into a file or register, the content to be saved can be selected among the following 4 options:

- Instrument status only (see *Users Guide* for setting items to be saved)
- Instrument status and calibration coefficient array.
- Instrument status, corrected data/memory array (measurement data)
- Instrument status, calibration coefficient array, and corrected data/memory array (measurement data)

To select a content to be saved, use the following command:

- :MMEM:STOR:STYP on page 361

Selecting Content to be Saved

To select whether to save the setting of all channels/traces or that of the displayed channels/traces, use the following command:

- :MMEM:STOR:SALL on page 359

Saving and recalling entire instrument status

To save the entire instrument status into a file, use the following command:

- :MMEM:STOR on page 351

Recalling a file saved with the above command can reproduce the status when it was saved. To recall the settings from a file, use the following command:

- :MMEM:LOAD on page 343

Auto recall

The file saved with the name autorec.sta or A:autorec.sta will be automatically recalled the E5061A/E5062A is powered ON.

Saving state for each channel into a register

For the active channel, when you want to save the instrument state specific to that channel only into one of registers A to D, use the following command:

- :MMEM:STOR:CHAN on page 352

Recalling an instrument state saved in a register can reproduce it as the state of the active channel. To recall a register, use the following command:

- :MMEM:LOAD:CHAN on page 344

NOTE

It is possible to recall a file from a different channel where it was saved.

The contents in the registers are lost when you turn OFF the power. You can delete (clear) the contents of all the registers using the following command.

- :MMEM:STOR:CHAN:CLE on page 352

Saving measurement data

Measurement data (in a formatted data array) can be saved in the file with CSV (Comma Separated Value) format.

To save measurement data on a file, use the following command:

- :MMEM:STOR:FDAT on page 354

Executing the above command will save the measurement data of the active trace. Note that the data save using the above command cannot be recalled from the E5061A/E5062A.

Saving the images on the LCD screen

Images displayed on the LCD screen can be saved on a file in the bitmap (.bmp) or portable network graphics (.png) format.

To save screen image on a file, use the following command:

- :MMEM:STOR:IMAG on page 355

Executing the above command will save the screen image when the command is invoked.

NOTE

Note that this gives different result than operation from the front panel where screen image is saved at the time **[Capture]** key is pressed.

Saving and recalling the segment sweep table

Segment sweep table can be saved in the file with CSV (Comma Separated Value) format.

To save segment sweep table on a file, use the following command:

- :MMEM:STOR:SEGM on page 360

Executing the above command will save the segment sweep table for the active channel.

Recalling the file saved using the above command can reproduce the segment sweep table on the active channel.

To recall the settings from a file, use the following command:

- :MMEM:LOAD:SEGM on page 349

NOTE

It is possible to recall a file from a different channel where it was saved. Note that recalling operation is not guaranteed for the file that might have been modified with editor.

Saving and recalling the limit table

Limit table can be saved in the file with CSV (Comma Separated Value) format. To save limit table on a file, use the following command:

- :MMEM:STOR:LIM on page 356

Executing the above command will save the limit table for the active trace of the active channel.

Recalling the file saved using the above command can reproduce the limit table on the active trace of the active channel. To recall the settings from a file, use the following command:

- :MMEM:LOAD:LIM on page 346

NOTE

It is possible to recall a file from a different channel or trace where it was saved. Note that recalling operation is not guaranteed for the file that might have been modified with editor.

Saving/loading (importing) the VBA program

Saving

Only the VBA project file can be saved using command.

To save the VBA project that is opened on the VBA editor on the file, use the following command.

- :MMEM:STOR:PROG on page 357

Loading (importing)

To load the VBA project to the VBA editor, or to import the module/form file, use the following command.

- :MMEM:LOAD:PROG on page 347

Executing above command will load/import the file according to its extension as follows:

Extension	File type
vba	VBA Project
bas	Standard module
frm	User Forms
cls	Class Modules

Sample program

Example 9-1 shows a sample program that demonstrates how to save a file. You can find the source file of this program, named file_sav.bas, on the sample program disk.

This program saves selected content on a file with a specified name.

The program is described in detail below:

Line 40	Assigns a GPIB address to the I/O pass.
Line 60	Allows the user to return to the entry start line and re-enter the data if an error (such as an invalid entry) occurs while entering the number that identifies the content to be saved.
Lines 80 to 180	These lines display the list of options for content to be saved, and prompt the user to choose one of the items by typing in the appropriate number.
Line 190	Converts the entered value into an integer and stores it into the Content variable.
Line 200	Returns to the entry start line if an invalid value is contained in Content.
Line 230	Passes control to a subprogram named Inp_file_name, which lets the user input a file name for saving, and then stores the returned file name into the File\$ variable.
Lines 270 to 280	If Content is equal to 1, these lines set the content to be saved as the instrument status to “instrument status only”, and store the state with the file name which is combined the File\$ variable with the extension “.sta”.
Lines 300 to 310	If Content is equal to 2, these lines set the content to be saved as the instrument status to “instrument status and calibration coefficient”, and store the state with the file name which is combined the File\$ variable with the extension “.sta”.
Lines 330 to 340	If Content is equal to 3, these lines set the content to be saved as the instrument status to “instrument status and measurement data”, and store the state with the file name which is combined the File\$ variable with the extension “.sta”.
Lines 360 to 370	If Content is equal to 4, these lines set the content to be saved as the instrument status to “instrument status, calibration coefficient, and measurement data”, and store the state with the file name which is combined the File\$ variable with the extension “.sta”.
Line 390	If Content is equal to 5, and store the state with the file name which is combined the File\$ variable with the extension “.csv”.
Line 410	If Content is equal to 6, and store the image data of the LCD screen with the file name which is combined the File\$ variable with the extension “.bmp”.

The `Inp_file_name` subprogram in lines 480 to 590, which is used to enter a save filename, is described below.

- Line 500 Allows the user to return to the entry start line and re-enter the data if an error (such as an invalid entry) occurs while entering the target file name.
- Lines 520 to 540 These lines prompt the user to enter the target file name. The program does not continue till the user actually enters the file name.
- Lines 550 to 560 These lines display the entered file name and waits for a confirmation entry (y/n key).
- Line 570 Returns to the entry start line if the key the user pressed in line 560 is not the y key.

Example 9-1

Saving file (file_sav.htb)

```

10     DIM File$(300),Inp_char$(30)
20     INTEGER Content
30     CLEAR SCREEN
40     ASSIGN @Agte507x TO 717
50     !
60     ON ERROR GOTO Content_select
70 Content_select: !
80     PRINT "## Save Content Selection ##"
90     PRINT "Select Content"
100    PRINT " 1: State (State only)"
110    PRINT " 2: State (State & Cal)"
120    PRINT " 3: State (State & Trace)"
130    PRINT " 4: State (State & Cal & Trace)"
140    PRINT " 5: Trace Data (CSV)"
150    PRINT " 6: Screen"
160    PRINT ""
170    PRINT "Input 1 to 6"
180    INPUT "Number?",Inp_char$
190    Content=IVAL(Inp_char$,10)
200    IF Content<1 OR Content>6 THEN Content_select
210    OFF ERROR
220    !
230    CALL Inp_file_name(File$)
240    !
250    SELECT Content
260      CASE 1
270        OUTPUT @Agte507x;":MMEM:STOR:STYP STAT"
280        OUTPUT @Agte507x;":MMEM:STOR ""&File$&".sta""
290      CASE 2
300        OUTPUT @Agte507x;":MMEM:STOR:STYP CST"
310        OUTPUT @Agte507x;":MMEM:STOR ""&File$&".sta""
320      CASE 3
330        OUTPUT @Agte507x;":MMEM:STOR:STYP DST"
340        OUTPUT @Agte507x;":MMEM:STOR ""&File$&".sta""
350      CASE 4
360        OUTPUT @Agte507x;":MMEM:STOR:STYP CDST"
370        OUTPUT @Agte507x;":MMEM:STOR ""&File$&".sta""
380      CASE 5
390        OUTPUT @Agte507x;":MMEM:STOR:FDAT ""&File$&".csv""
400      CASE 6

```

Saving and Recalling (File Management)

Saving and Recalling File

```
410         OUTPUT @Agte507x;":MMEM:STOR:IMAG ""&File$&".bmp""
420     END SELECT
430     !
440     END
450     !=====
460     ! File Name Input Function
470     !=====
480     SUB Inp_file_name(Inp_name$)
490         DIM Inp_char$(9)
500         ON ERROR GOTO Inp_start
510     Inp_start: !
520         PRINT "## File Name Input ##"
530         PRINT "Input Save File Name (without Extension)"
540         INPUT "Name?",Inp_name$
550         PRINT "Input Name: "&Inp_name$
560         INPUT "OK? [Y/N]",Inp_char$
570         IF UPC$(Inp_char$)<>"Y" THEN Inp_start
580         OFF ERROR
590     SUBEND
```

Managing Files

Creating directory (folder)

To create a directory (folder), use the following command:

- :MMEM:MDIR on page 350

Deleting file (directory)

To delete a file or a directory, use the following command:

- :MMEM:DEL on page 342

Copying file

To copy a file, use the following command:

- :MMEM:COPY on page 341

Transferring files

File transfer from the external controller to the E5061A/E5062A can be possible by reading data from a file on the controller and then writing them to the file on the E5061A/E5062A.

- :MMEM:TRAN on page 362

Also, file transfer from the E5061A/E5062A to the external controller can be possible by reading data from a file on the E5061A/E5062A using the commands as query and then writing them to the file on the controller.

Retrieving data from storage

To retrieve information for the storage that is built in the E5061A/E5062A (usage, property of file located in a specified directory), use the following command;

- :MMEM:CAT? on page 340

Sample program

Example 9-1 shows a sample program for transferring files between the external controller and the E5061A/E5062A. You can find the source file of this program, named file_xfr.bas, on the sample program disk.

This program reads out data from a specified file on the external controller (or the E5061A/E5062A), then write them to a specified file on the E5061A/E5062A(or the external controller).

The program is described in detail below:

- | | |
|------------------|---|
| Line 40 | Assigns a GPIB address to the I/O pass. |
| Lines 60 to 130 | These line allow the user to return to the entry start line and re-enter the data if an error (such as an invalid entry) occurs while entering the number that indicates the transfer direction. Then, these line display the list of transfer directions and prompt the user to input a selected number. |
| Lines 80 to 130 | These lines display the list of transfer directions, and prompt the user to choose one of the items by typing in the appropriate number. |
| Lines 140 to 150 | Converts the entered value into an integer and stores it into the Direction variable. Returns to the entry start line if an invalid value is contained in Direction. |
| Lines 180 to 210 | These lines obtain the name of the source file for copying from the user input, store it into the Src_file\$ variable, and display the value of Src_file\$. |
| Lines 180 to 210 | These lines obtain the name of the source file for copying from the user input, store it into the Src_file\$ variable, and display the value of Src_file\$. |
| Lines 230 to 270 | If Direction is equal to 2 (from the external controller to the E5061A/E5062A), these lines obtain the size of the source file for copying, store it into the Src_size_char\$, and display the value of Src_size_char\$. |
| Lines 290 to 320 | These lines obtain the name of the destination file for copying from the user input, store it into the Dst_file\$ variable, and display the value of Dst_file\$. |
| Line 350 | If Direction is equal to 1 (from the E5061A/E5062A to the external controller), these lines use the subprogram Copy_to_contr to transfer (copy) a file with the name Src_file\$ on the E5061A/E5062A to a file with the name Dst_file\$ on the external controller. |
| Line 370 | If Direction is equal to 2, these lines use the subprogram Copy_to_e507x to transfer (copy) a file with the name Src_file\$ on the external controller to a file with the name Dst_file\$ on the E5061A/E5062A. |
- Copy_to_contr, a subprogram for transferring files from the E5061A/E5062A to the external controller that appears in lines 440 to 1000, is described below.
- | | |
|------------------|--|
| Lines 490 to 520 | If any file with the name File\$ already exists, these lines delete the file and newly create a file with the name File\$. |
| Line 530 | Assigns a destination file for copying to the I/O pass. |

- Line 540 This line stores a maximum number of transferred data (in bytes) per one transfer, that is 24 KByte to meet the size limitation of string arrays in the HTBasic, into Max_bsize variable.
- Lines 560 to 600 These lines configure the system to generate an SRQ when it cannot find a source file for copying due to an error.
- Lines 620 to 630 These lines set the branch target for an SRQ interrupt to enable SRQ interrupts.
- Lines 640 to 650 These lines display a message showing that the transfer has started, and execute commands for reading data from a file on the E5061A/E5062A.
- Lines 670 to 680 These lines read the header symbol (#) in a block data, read number of digits (characters) indicating the size of data in bytes, then store it into Digit\$ variable.
- Line 690 This line creates a format for reading characters in Digit\$.
- Line 700 This line reads the data size in byte and stores it into Src_size_char\$ variable.
- Line 720 This line converts Src_size_char\$ to a real number and stores it into Src_size variable.
- Lines 730 to 870 These lines repeat the procedures below until Src_size reaches 0.
- Lines 740 to 780: If Src_size is greater than Max_bsize, these lines assign the value of the Max_bsize to Block_size variable (transferred data in bytes). If Src_size is equal or less than Max_bsize, assign the value of Src_size to Block_size.
- Line 800 This line defines Dat\$ string variable with the size as large as Block_size and reserves memory area.
- Line 810 This line creates a format for reading characters as many as Block_size characters.
- Line 820 This line reads data from the file on the E5061A/E5062A, then stores them into Dat\$.
- Line 830 This line writes the contents of Dat\$ to the file on the external controller.
- Lines 840 to 860 These lines free the memory area for Dat\$ and subtract Block_size from Src_size.
- Lines 890 to 900 These lines display a message showing the completion of transfer, then read a message terminator at the end of the data.
- Lines 940 to 980 These lines define an error handler that retrieves and displays the number and message of an error that has occurred.
- Copy_to_e507x, a subprogram for transferring files from the external controller to the E5061A/E5062A that appears in lines 1040 to 1540, is described below.
- Lines 1090 to 1110 Assigns a destination file for copying to the I/O pass.
- Line 1120 This line stores a maximum number of transferred data (in bytes) per one transfer, that is 24 KByte, into Max_bsize variable.
- Lines 1140 to 1160 Clears the error queue.

Saving and Recalling (File Management)

Managing Files

- Line 1180 Displays a measurement start message.
- Lines 1190 to 1200 These lines create the header part indicating that data will be sent as many as Src_size_char\$ bytes, then send the header part of the command and its parameters for writing the data to the file on the E5061A/E5062A.
- Line 1220 This line converts Src_size_char\$ to a real number and stores it into Src_size variable.
- Lines 1230 to 1370 These lines repeat the procedures below until Src_size reaches 0.
- Lines 1240 to 1280: If Src_size is greater than Max_bsize, these lines assign the value of the Max_bsize to Block_size variable (transferred data in bytes). If Src_size is equal or less than Max_bsize, assign the value of Src_size to Block_size.
- Line 1300 This line defines Dat\$ string variable with the size as large as Block_size and reserves memory area.
- Line 1310 This line creates a format for reading characters as many as Block_size characters.
- Line 1320 This line reads data from the file on the external controller, then stores them into Dat\$.
- Line 1330 This line writes the contents of Dat\$ to the file on the E5061A/E5062A.
- Lines 1340 to 1360 These lines free the memory area for Dat\$ and subtract Block_size from Src_size.
- Line 1390 This line sends a message terminator at the end of data.
- Lines 1420 to 1430 These lines retrieve the error number and error message from the error queue, and then store them into the variables Err_no and Err_msg\$, respectively.
- Lines 1440 to 1490 If Err_no is equal to 0 (no error occurred), these lines display the message indicating completion of transfer, and if Err_no is not equal to 0 (an error occurred), display Err_no along with Err_msg\$.
- Lines 1510 to 1520 These lines handle the case with no source file for copying is found.

Example 9-2 File transfer (file_xfr.htb)

```

10     DIM Src_file$[50],Dst_file$[50],Src_size_char$[50],Inp_char$[30]
20     INTEGER Direction
30     ASSIGN @Agte507x TO 717
40     !
50     CLEAR SCREEN
60     ON ERROR GOTO Direct_select
70 Direct_select: !
80     PRINT "#### File Transfer ####"
90     PRINT " 1: E507x -> Controller"
100    PRINT " 2: Controller -> E507x"
110    PRINT ""
120    PRINT "Input 1 or 2"
130    INPUT "Number?",Inp_char$
140    Direction=IVAL(Inp_char$,10)
150    IF Direction<1 OR Direction>2 THEN Direct_select
160    OFF ERROR
170    !
180    PRINT ""
190    PRINT " Input source file name.      ";
200    INPUT "Name?",Src_file$
210    PRINT ": "&Src_file$
220    !
230    IF Direction=2 THEN
240        PRINT " Input source file size.      ";
250        INPUT "Size[Byte]?",Src_size_char$
260        PRINT ": "&Src_size_char$&"[Byte]"
270    END IF
280    !
290    PRINT " Input destination file name.  ";
300    INPUT "Name?",Dst_file$
310    PRINT ": "&Dst_file$
320    PRINT ""
330    !
340    IF Direction=1 THEN
350        Copy_to_contr(@Agte507x,Src_file$,Dst_file$)
360    ELSE
370        Copy_to_e507x(@Agte507x,Src_file$,Src_size_char$,Dst_file$)
380    END IF
390    !
400    END
410    !=====
420    ! File Transfer Function (E507x -> Controller)
430    !=====
440    SUB Copy_to_contr(@Agte507x,Src_file$,Dst_file$)
450        DIM Img$[32],Src_size_char$[10],Buff$[9],Err_msg$[100]
460        INTEGER Max_bsize,Block_size,Err_no
470        REAL Src_size
480        !
490        ON ERROR GOTO Skip_purge
500        PURGE Dst_file$
510 Skip_purge: OFF ERROR
520        CREATE Dst_file$,1
530        ASSIGN @Dst_file TO Dst_file$
540        Max_bsize=24576 ! 24KByte
550        !
560        OUTPUT @Agte507x;"*ESE 60"
570        OUTPUT @Agte507x;"*SRE 32"
580        OUTPUT @Agte507x;"*CLS"
590        OUTPUT @Agte507x;"*OPC?"
600        ENTER @Agte507x;Buff$
610        !

```

Saving and Recalling (File Management)

Managing Files

```
620     ON INTR 7 GOTO Err
630     ENABLE INTR 7;2
640     PRINT "Now Copying: "&Src_file$&" (@E507x) -> "&Dst_file$&" (@Contro
ller)"
650     OUTPUT @Agte507x;":MMEM:TRAN? ""&Src_file$&""
660     WAIT .1
670     ENTER @Agte507x USING "#,A";Buff$
680     ENTER @Agte507x USING "#,A";Digit$
690     Img$="#,"&Digit$&"A"
700     ENTER @Agte507x USING Img$;Src_size_char$
710     !
720     Src_size=VAL(Src_size_char$)
730     WHILE Src_size>0
740         IF Src_size>Max_bsize THEN
750             Block_size=Max_bsize
760         ELSE
770             Block_size=Src_size
780         END IF
790         !
800         ALLOCATE Dat$[Block_size]
810         Img$="#,"&VAL$(Block_size)&"A"
820         ENTER @Agte507x USING Img$;Dat$
830         OUTPUT @Dst_file USING Img$;Dat$
840         DEALLOCATE Dat$
850         !
860         Src_size=Src_size-Block_size
870     END WHILE
880     !
890     PRINT "Done"
900     ENTER @Agte507x USING "#,A";Buff$
910     ASSIGN @Dst_file TO *
920     !
930     GOTO Skip_error
940 Err: OFF INTR 7
950     OUTPUT @Agte507x;":SYST:ERR?"
960     ENTER @Agte507x;Err_no,Err_msg$
970     PRINT "Error occurred!!"
980     PRINT " No:";Err_no,"Description: "&Err_msg$
990 Skip_error: OFF INTR 7
1000 SUBEND
1010     !=====
1020     ! File Transfer Function (Controller -> E507x)
1030     !=====
1040 SUB Copy_to_e507x(@Agte507x,Src_file$,Src_size_char$,Dst_file$)
1050 DIM Img$[32],Header$[10],Buff$[9],Err_msg$[100]
1060 INTEGER Max_bsize,Block_size,Err_no
1070 REAL Src_size
1080 !
1090 ON ERROR GOTO File_error
1100 ASSIGN @Src_file TO Src_file$
1110 OFF ERROR
1120 Max_bsize=24576 ! 24KByte
1130 !
1140 OUTPUT @Agte507x;"*CLS"
1150 OUTPUT @Agte507x;"*OPC?"
1160 ENTER @Agte507x;Buff$
1170 !
1180 PRINT "Now Copying: "&Src_file$&" (@Controller) -> "&Dst_file$&" (@
E507x)"
1190 Header$="#&VAL$(LEN(Src_size_char$))&Src_size_char$
1200 OUTPUT @Agte507x;":MMEM:TRAN ""&Dst_file$&""&Header$;
1210 !
1220 Src_size=VAL(Src_size_char$)
1230 WHILE Src_size>0
```

```
1240     IF Src_size>Max_bsize THEN
1250         Block_size=Max_bsize
1260     ELSE
1270         Block_size=Src_size
1280     END IF
1290     !
1300     ALLOCATE Dat$(Block_size)
1310     Img$="#,&VAL$(Block_size)&"A"
1320     ENTER @Src_file USING Img$;Dat$
1330     OUTPUT @Agte507x USING Img$;Dat$
1340     DEALLOCATE Dat$
1350     !
1360     Src_size=Src_size-Block_size
1370 END WHILE
1380     !
1390     OUTPUT @Agte507x;"",END
1400     ASSIGN @Src_file TO *
1410     !
1420     OUTPUT @Agte507x;"::SYST:ERR?"
1430     ENTER @Agte507x;Err_no,Err_msg$
1440     IF Err_no=0 THEN
1450         PRINT "Done"
1460     ELSE
1470         PRINT "Error occurred!!"
1480         PRINT "  No: ";Err_no,"Description: "&Err_msg$
1490     END IF
1500     GOTO Skip_error
1510 File_error:OFF ERROR
1520     PRINT "File name NOT found!"
1530 Skip_error:~
1540 SUBEND
```

Saving and Recalling (File Management)
Managing Files

10

Communication with External Instruments Using Handler I/O Port

This chapter provides necessary information for communicating with external instruments (for example, a handler in a production line) using the handler I/O port equipped with the Agilent E5061A/E5062A.

Handler I/O Port Overview

The E5061A/E5062A handler I/O port provides four independent parallel ports for data I/O associated with several control signal lines and the power line. All signals operate in TTL logic.

The data I/O ports are configured with 2 pairs of 8 bit output port and 2 pairs of 4 bit bi-directional port. Also those ports can cooperate to provide a maximum 16-bit-width output port or a maximum 8-bit-width input port.

The I/O signals operate on the negative logic basis. The control signal lines consist of various control output data, including completion of measurement or control signal for handshaking. Figure 10-1 outlines the I/O ports and control signal lines.

Figure 10-1

Handler I/O port overview

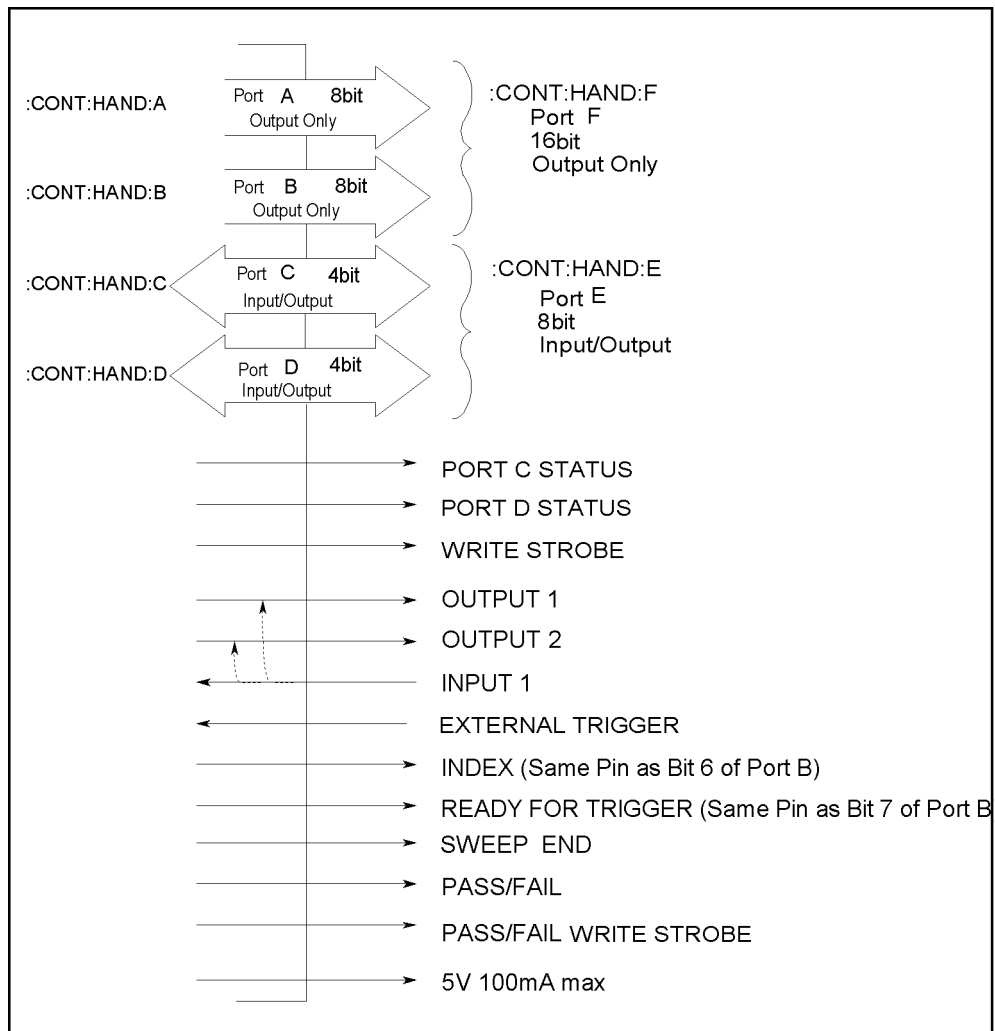

e5070ape001

I/O Signal Pin Layout and Description

Figure 10-2 illustrates the layout of the I/O signal pins on the handler interface connector while Table 10-1 on page 148 briefly describes those signals.

Figure 10-2

Handler interface connector pin layout

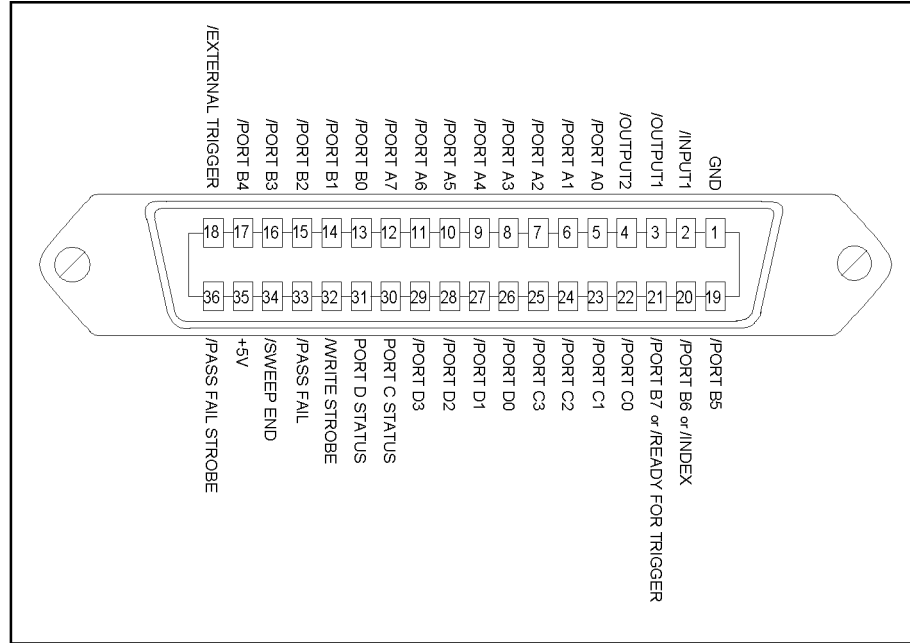

e5070ape002

NOTE A slash (/) symbol preceding signal names means that they are negative logic (active low).

Table 10-1

Description of the handler interface I/O signals

Pin number	Signal name	Input/Output	Description
1	GND	—	Ground.
2	/INPUT1	Input	When this port receives a negative pulse, /OUTPUT1 and /OUTPUT2 are changed to the Low level.
3	/OUTPUT1	Output	Changes to the Low level when /INPUT1 receives a negative pulse. A command can be available for altering the Low/High level logic.
4	/OUTPUT2	Output	Changes to the Low level when /INPUT1 receives a negative pulse. A command can be available for altering the Low/High level logic.
5	/PORT A0	Output	Bit 0 of the port A (8 bit parallel output port)
6	/PORT A1	Output	Bit 1 of the port A.
7	/PORT A2	Output	Bit 2 of the port A.
8	/PORT A3	Output	Bit 3 of the port A.
9	/PORT A4	Output	Bit 4 of the port A.
10	/PORT A5	Output	Bit 5 of the port A.
11	/PORT A6	Output	Bit 6 of the port A.
12	/PORT A7	Output	Bit 7 of the port A.
13	/PORT B0	Output	Bit 0 of the port B (8 bit parallel output port)
14	/PORT B1	Output	Bit 1 of the port B.
15	/PORT B2	Output	Bit 2 of the port B.
16	/PORT B3	Output	Bit 3 of the port B.
17	/PORT B4	Output	Bit 4 of the port B.
18	/EXTERNAL TRIGGER	Input	An external trigger signal. When the trigger source is set to the “External,” this port generates a trigger in respond to the trailing edge of a negative pulse.
19	/PORT B5	Output	Bit 5 of the port B.
20*1	/PORT B6	Output	Bit 6 of the port B.
	/INDEX		Indicates that analog measurement is complete. The /INDEX signal changes to the Low level when analog measurement (all sweeps of all channels) is complete. When the handler receives the signal, it assumes that it is ready to connect the next DUT. However, no measurement data is available until data calculation completes.
21*2	/PORT B7	Output	Bit 7 of the port B.
	/READY FOR TRIGGER		Indicates that the instrument is ready for triggering. This signal is changed to the Low level when the instrument is ready for receiving a trigger signal.

Table 10-1

Description of the handler interface I/O signals

Pin number	Signal name	Input/Output	Description
22	/PORT C0	Input/Output	Bit 0 of the port C (4 bit parallel I/O port)
23	/PORT C1	Input/Output	Bit 1 of the port C.
24	/PORT C2	Input/Output	Bit 2 of the port C.
25	/PORT C3	Input/Output	Bit 3 of the port C.
26	/PORT D0	Input/Output	Bit 0 of the port D (4 bit parallel I/O port)
27	/PORT D1	Input/Output	Bit 1 of the port D.
28	/PORT D2	Input/Output	Bit 2 of the port D.
29	/PORT D3	Input/Output	Bit 3 of the port D.
30	PORT C STATUS	Output	Port C status signal. This signal is changed to the High level when the port C is configured to output port. It is changed to the Low level when the port is configured to input port.
31	PORT D STATUS	Output	Port D status signal. This signal is changed to the High level when the port D is configured to output port. It is changed to the Low level when the port is configured to input port.
32	/WRITE STROBE	Output	A output port write strobe signal. When data is present (that is, output level changes) on any of the output ports, this signal provides a negative pulse.
33	/PASS FAIL	Output	A limit test result* ³ signal. This signal changes to the High level when limit test, bandwidth test, or ripple test results return FAIL. It changes to the Low level when all limit test results return PASS.
34	/SWEEP END	Output	A sweep completion signal. When measurement (all sweeps of all channels) and data calculation are completed, this signal provides this signal provides a negative pulse.
35	+5V	Output	Provides +5V DC power supply for external instruments.
36	/PASS FAIL STROBE	Output	Limit test result write strobe signal. When limit test result is present on /PASS FAIL, this signal provides a negative pulse.

*1. This signal provides various functions depending upon the setting of :CONT:HAND:IND:STAT command on page 300.

*2. This signal provides various functions depending upon the setting of :CONT:HAND:RTR:STAT command on page 301.

*3. The overall test result that combine the test results for all traces in all channels.

Inputting/Outputting Data

The E5061A/E5062A handler I/O port provides the ports for data I/O shown in Table 10-2.

Table 10-2

I/O port

Port Name	Usage	Data Structure																
Port A	Output	<table border="1" style="margin-left: auto; margin-right: auto;"> <tr> <td>A7</td><td>A6</td><td>A5</td><td>A4</td><td>A3</td><td>A2</td><td>A1</td><td>A0</td> </tr> </table> <p style="text-align: center;">8 bits</p>	A7	A6	A5	A4	A3	A2	A1	A0								
A7	A6	A5	A4	A3	A2	A1	A0											
Port B	Output	<table border="1" style="margin-left: auto; margin-right: auto;"> <tr> <td>B7</td><td>B6</td><td>B5</td><td>B4</td><td>B3</td><td>B2</td><td>B1</td><td>B0</td> </tr> </table> <p style="text-align: center;">8 bits</p>	B7	B6	B5	B4	B3	B2	B1	B0								
B7	B6	B5	B4	B3	B2	B1	B0											
Port C	Input/Output	<table border="1" style="margin-left: auto; margin-right: auto;"> <tr> <td>C3</td><td>C2</td><td>C1</td><td>C0</td> </tr> </table> <p style="text-align: center;">4 bits</p>	C3	C2	C1	C0												
C3	C2	C1	C0															
Port D	Input/Output	<table border="1" style="margin-left: auto; margin-right: auto;"> <tr> <td>D3</td><td>D2</td><td>D1</td><td>D0</td> </tr> </table> <p style="text-align: center;">4 bits</p>	D3	D2	D1	D0												
D3	D2	D1	D0															
Port E	Input/Output	<table border="1" style="margin-left: auto; margin-right: auto;"> <tr> <td>D3</td><td>D2</td><td>D1</td><td>D0</td><td>C3</td><td>C2</td><td>C1</td><td>C0</td> </tr> </table> <p style="text-align: center;">8 bits</p>	D3	D2	D1	D0	C3	C2	C1	C0								
D3	D2	D1	D0	C3	C2	C1	C0											
Port F	Output	<table border="1" style="margin-left: auto; margin-right: auto;"> <tr> <td>B7</td><td>B6</td><td>B5</td><td>B4</td><td>B3</td><td>B2</td><td>B1</td><td>B0</td><td>A7</td><td>A6</td><td>A5</td><td>A4</td><td>A3</td><td>A2</td><td>A1</td><td>A0</td> </tr> </table> <p style="text-align: center;">16 bits</p>	B7	B6	B5	B4	B3	B2	B1	B0	A7	A6	A5	A4	A3	A2	A1	A0
B7	B6	B5	B4	B3	B2	B1	B0	A7	A6	A5	A4	A3	A2	A1	A0			

Specifying signal direction of port

Signal direction (input/output) can be changed for the ports C, D, and D as shown in Table 10-2. Thus, before the ports are used, the directions should be determined according to their usage.

To specify the signal direction for the ports C and D, use the following command. Direction for the port E depends on the setting for the ports C and D.

Port Name	Command
Port C	:CONT:HAND:C:MODE on page 295
Port D	:CONT:HAND:D:MODE on page 297

Reading data input to port

When the ports C, D, or E is configured to input ports, binary data represented with High(0)/Low(1) of each bit of the port will be read as decimal data.

To retrieve the data, use the following command as query:

Port Name	Command
Port C	:CONT:HAND:C on page 294
Port D	:CONT:HAND:D on page 296
Port E	:CONT:HAND:E on page 298

Data output to port

To the ports A through F (the ports C, D, and E should be configured to output ports), binary data (decimal data when output data is specified with a command) represented with High(0)/Low(1) of each bit of the port can be output.

To output data, use the following command.

Port Name	Command
Port A	:CONT:HAND:A on page 293
Port B	:CONT:HAND:B on page 293
Port C	:CONT:HAND:C on page 294
Port D	:CONT:HAND:D on page 296
Port E	:CONT:HAND:E on page 298
Port F	:CONT:HAND:F on page 299

NOTE

The bit 6 of the data outputted by **:CONT:HAND:B** command (the bit 14 of the data outputted by **:CONT:HAND:F** command) is ignored when outputting the /INDEX signal is turned on.

The bit 7 of the data outputted by **:CONT:HAND:B** command (the bit 15 of the data outputted by **:CONT:HAND:F** command) is ignored when outputting the /READY FOR TRIGGER signal is turned on.

Preset states at power-on

The handler I/O port is set at power-on as follows (not affected at reset).

Port A	High (All Bits)
Port B	High (All Bits)
Port C	Input
Port D	Input
PORT C STATUS	Low
PORT D STATUS	Low
/OUTPUT1	High
/OUTPUT2	High
/SWEEP END	High
/PASS FAIL	High

Timing Chart

Figure 10-3 shows a timing chart for each timing signal output covering from the start of measurement (pulse input to /EXTERNAL TRIGGER) until the end of measurement.

Table 10-3

Values of T1 through T2 in Figure 10-3 (typical)

		Minimum value	Typical Value	Maximum value
T1	Pulse width of /EXTERNAL TRIGGER	1 μs ^{*1}	—	—
T2	Pulse width of /SWEEP END	10 μs	12 μs	—

*1. When a trigger signal is input from the handler I/O port.

Figure 10-3

Timing chart of /EXTERNAL TRIGGER, /INDEX, /SWEEP END and /READY FOR TRIGGER

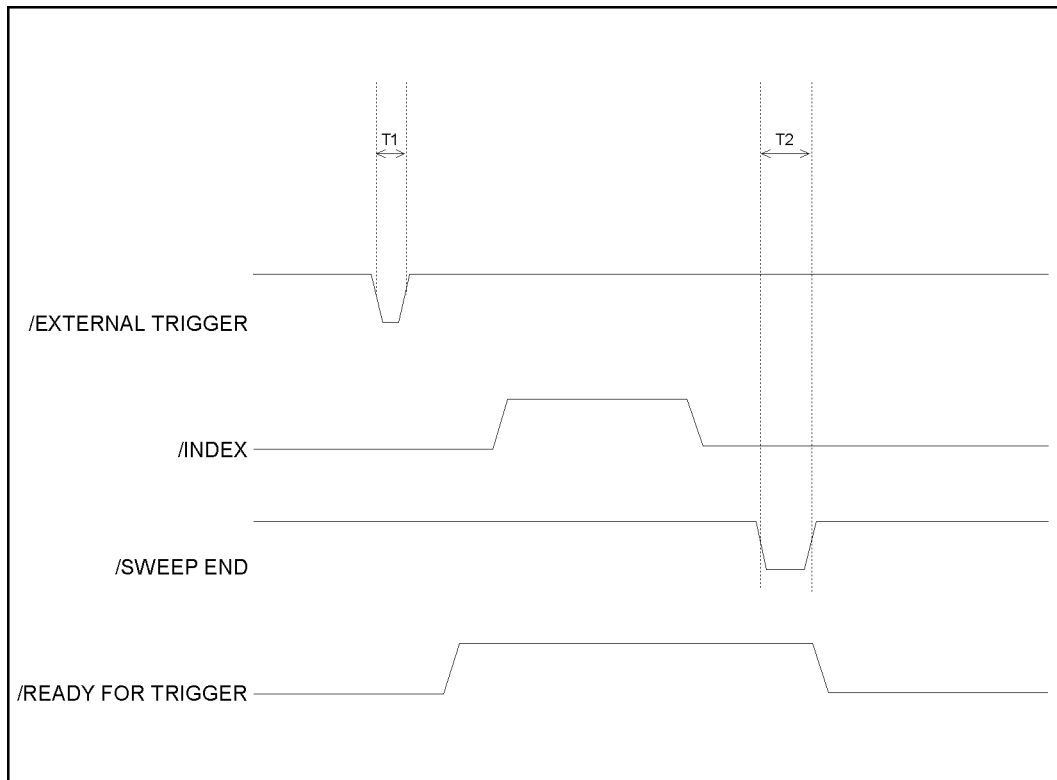

e5070apj009

/INDEX and /READY FOR TRIGGER signals are outputted when outputting of these signals are turned on using the following commands.

/INDEX	:CONT:HAND:C:MODE on page 295
/READY FOR TRIGGER	:CONT:HAND:D:MODE on page 297

Communication with External Instruments Using Handler I/O Port
Timing Chart

Figure 10-4 shows the timing chart for data output and write strobe signal output to the ports A through F.

Table 10-4 Values of T1 through T2 in Figure 10-4 (typical)

T1	Response time of write strobe signal	1 μ s
T2	Pulse width of write strobe signal	1 μ s

Figure 10-4 Timing chart of data output and write strobe signal

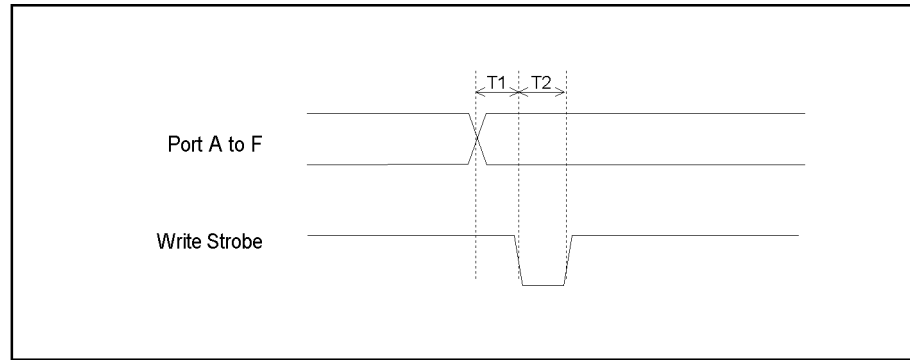

e5070ape010

Figure 10-5 shows a timing chart of limit test result output (/PASS FAIL signal output) and /PASS FAIL write strobe signal output.

Timing chart of limit test result contains ripple test and bandwidth test.

Table 10-5 Values of T1 through T2 in Figure 10-5 (typical)

T1	Response time of /PASS FAIL write strobe	1 μ s
T2	Pulse width of /PASS FAIL write strobe	1 μ s

Figure 10-5 Timing chart of limit test result output and write strobe signal

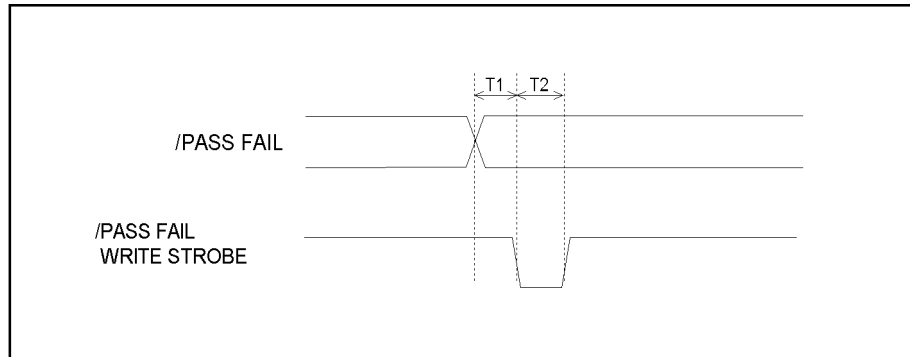

e5070ape011

Figure 10-6 shows a timing chart of a pulse input to /INPUT1, /OUTPUT1 signal output, and /OUTPUT2 signal output.

Table 10-6

Values of T1 through T2 in Figure 10-6 (typical)

		Minimum value	Maximum value
T1	Pulse width of /INPUT1	1 μ s	—
T2	Response time of /OUTPUT1, /OUTPUT2	0.4 μ s	0.6 μ s

Figure 10-6

Timing chart of /INPUT1 and /OUTPUT1, /OUTPUT2

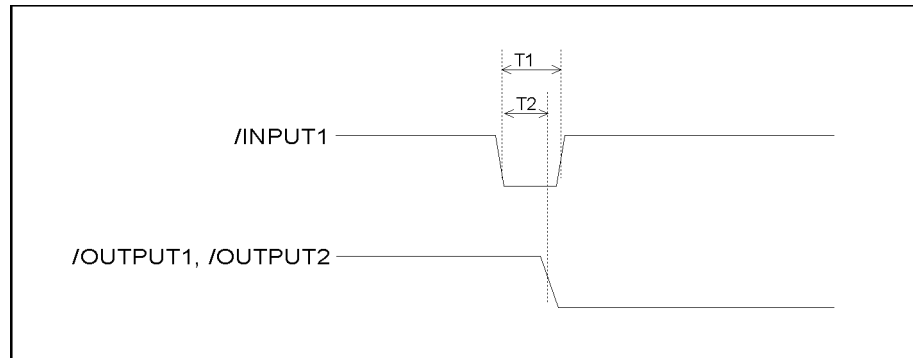

e5070apj012

Electrical Characteristics

Input signal

All input signals are TTL compatible. Table 10-7 shows the electrical characteristics of input signals. Figure 10-7 shows the circuit diagram of input signals.

Table 10-7

Electrical characteristics of input signals (typical)

Maximum rate input voltage		-0.5 V to 5.5 V
Input voltage	High level	2.0 V to 5.0 V
	Low level	0 V to 0.5 V

Figure 10-7

Circuit diagram or input signals

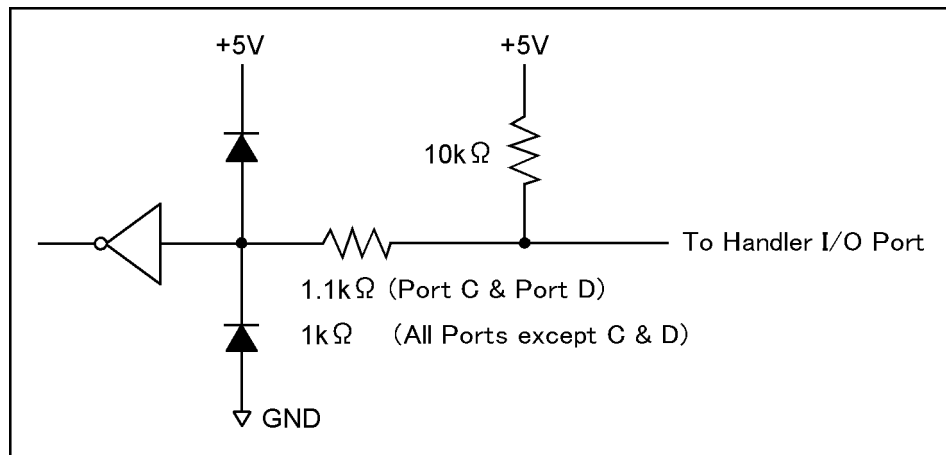

e5070ape027

Output signal

All output signals are TTL compatible. Table 10-8 shows the electrical characteristics of output signals. Figure 10-8 shows the circuit diagram of output signals.

Table 10-8 Electrical characteristics of output signals (typical)

Maximum rate output current		-10 mA to 10 mA
Output current	High level	-5 mA
	Low level	3 mA
Output voltage	High level	2.0 V to 3.3 V (when output current is from -5 mA to 0 mA) 3.20 V (when output current is -1 mA) 2.75 V (when output current is -5 mA)
	Low level	0 V to 0.8 V (when output current is from 0 mA to 3 mA) 0.25 V* ¹ (when output current is 1 mA) 0.55 V (when output current is 3 mA)

*1. Notice that, in case of C0 to C3 (port C) and D0 to D3 (port D), output voltage is 0.30 V.

Figure 10-8 Circuit diagram of output signals

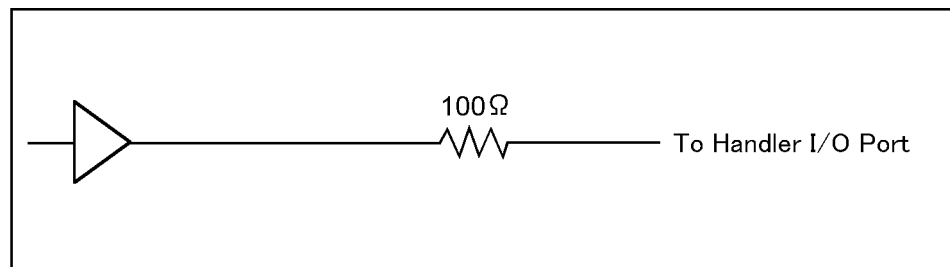

e5070ape028

Power supply (+5 V)

Table 10-9 shows electrical characteristics of +5 V power supply for external instruments.

Table 10-9 Electrical characteristics of +5 V power supply (typical)

Output voltage	4.5 V to 5.5 V
Maximum output current	100 mA

Sample Program

Example 10-1 provides a sample program that communicates with an external instrument through the handler I/O port. You can find the source file of this program, named `handler.htb`, on the sample program disk.

This program outputs 5 (sets bit 2 and bit 0 to Low, and the other bits to High) to the port A of the handler I/O port, then waits until the bit 3 of the port C is set to Low.

The program is described in detail below:

Line 40	Assigns a GPIB address to the I/O pass.
Lines 60 to 70	These lines store the output data on the port A (binary) and bit location (bit 3) into <code>Out_data_bin\$</code> and <code>Flag_bit</code> variables, respectively.
Line 90	This line configures the port C to input port.
Lines 100 to 110	These lines enable <code>/INDEX</code> and <code>/READY FOR TRIGGER</code> signals.
Lines 130 to 140	These lines convert <code>Out_data_bin\$</code> to a decimal value and set it to the port A.
Lines 160 to 200	These lines repeat reading data from the port C until <code>Flag_bit</code> becomes TRUE.

Example 10-1

Communicating with external instruments (`handler.htb`)

```
10    INTEGER Out_data, In_data, Bit_stat
20    DIM Out_data_bin$[9]
30    !
40    ASSIGN @Agte507x TO 717
50    !
60    Out_data_bin$="00000101"
70    Flag_bit=3
80    !
90    OUTPUT @Agte507x;":CONT:HAND:C:MODE INP"
100   OUTPUT @Agte507x;":CONT:HAND:IND:STAT ON"
110   OUTPUT @Agte507x;":CONT:HAND:RTR:STAT ON"
120   !
130   Out_data=IVAL(Out_data_bin$,2)
140   OUTPUT @Agte507x;":CONT:HAND:A ";Out_data
150   !
160   REPEAT
170     OUTPUT @Agte507x;":CONT:HAND:C?"
180     ENTER @Agte507x;In_data
190     Bit_stat=BIT(In_data,Flag_bit)
200   UNTIL Bit_stat=1
210   END
```

11 Working with Automatic Test Systems

This chapter describes useful features when the Agilent E5061A/E5062A is integrated with the automatic test system.

Preventing Erroneous Key Operation on the Front Panel (Key Lock Feature)

When no operation is required from the front panel controls, the mouse, or the keyboard, disabling those input devices can prevent from any erroneous operation, which might be caused by accidentally touching such devices.

To turn on or off Key Locking, use the following command:

Locking the front panel controls and the keyboard.	:SYST:KLOC:KBD on page 475
Locking the mouse and the touch screen.	:SYST:KLOC:MOUS on page 476

Improving Command Processing Speed

SCPI commands should be processed in shorter time to improve throughput, when those commands are frequently executed (for example, reading out trace for each measurement).

With E5061A/E5062A, processing time for SCPI commands can be improved by decreasing refresh rate of the LCD display.

Measurement results (trace) need not to be updated

When the measurement trace needs not to be updated, turn off the update of the LCD display. This improves processing speed of SCPI commands and eliminates updating time of the screen.

To turn off the update of the LCD display, use the following command:

- :DISP:ENAB command on page 310

Measurement results (trace) need to be updated

When the measurement trace needs to be updated, processing speed of SCPI commands can be improved by controlling the update timing of the LCD display:

- Step 1.** Execute all SCPI commands that are required before measurement, including commands setting conditions.
- Step 2.** Turning Off the update of the LCD display.
- Step 3.** Perform the measurement.
- Step 4.** Execute the commands for reading out measurement result or analyzing the result. Note that reading out the result in binary format will accelerate data transfer.
- Step 5.** Execute the following command to update the LCD display once.
 - :DISP:UPD command on page 316
- Step 6.** Return to the step 3.

Sample program

Example 11-2 shows a sample program where the command processing time are improved by controlling the update timing of the LCD display. You can find the source file of this program, named `cont_upd.htb`, on the sample program disk.

NOTE

This sample program correctly runs when the maximum number of channels/traces is set 9 channels/9 traces.

This program sets necessary measurement conditions then turn off the update of the LCD display. Next, it performs measurement, reads out the result, and update the screen once. This program repeats this measurement procedure ten times.

The program is described in detail below:

- | | |
|------------------|---|
| Lines 50 to 60 | Assigns a GPIB address to the I/O pass. |
| Lines 80 to 110 | These lines set the sweep type to linear sweep, the sweep center value to 950 MHz, the sweep span value to 100 MHz, and the number of measurement points to 201, respectively. |
| Lines 120 to 160 | These lines set the trigger source to bus trigger, turn on Continuous Activation mode for channel 1, turn the mode off for channels 2 through 4. |
| Lines 180 to 190 | These lines display the window for channel 1 only, and arrange two graphs tiled horizontally. |
| Lines 210 to 270 | These lines set the number of traces for channel 1 to 2, the measurement parameter and its data format for trace 1 to S21 and Log Mag, and those for trace 2 to S11 and Log Mag, respectively. |
| Line 290 | This line turns Off the update of the LCD screen. |
| Line 300 | This line sets the data transfer format to binary. |
| Lines 320 to 540 | These lines repeat the following procedure ten times. <ol style="list-style-type: none">1. Lines 330 to 350 These lines trigger the instrument, and waits until the measurement cycle finishes.2. Lines 390 to 430: Reads out the formatted data array of trace 1 in channel 1.3. Lines 450 to 490: Reads out the formatted data array of trace 2 channel 1.4. Line 530 This line updates the LCD screen once. |

Example 11-1

Controlling the update timing of LCD display(cont_upd.htb)

```

10     REAL Trace1(1:201,1:2),Trace2(1:201,1:2)
20     DIM Buff$(9),Img$(30)
30     INTEGER Nop,I
40     !
50     ASSIGN @Agte507x TO 717
60     ASSIGN @Binary TO 717;FORMAT OFF
70     !
80     OUTPUT @Agte507x;":SENS1:SWE:TYPE LIN"
90     OUTPUT @Agte507x;":SENS1:FREQ:CENT 950E6"
100    OUTPUT @Agte507x;":SENS1:FREQ:SPAN 100E6"
110    OUTPUT @Agte507x;":SENS1:SWE:POIN 201"
120    OUTPUT @Agte507x;":TRIG:SOUR BUS"
130    OUTPUT @Agte507x;":INIT1:CONT ON"
140    FOR I=2 TO 4
150        OUTPUT @Agte507x;":INIT"&VAL$(I)&":CONT OFF"
160    NEXT I
170    !
180    OUTPUT @Agte507x;":DISP:SPL D1"
190    OUTPUT @Agte507x;":DISP:WIND1:SPL D1_2"
200    !
210    OUTPUT @Agte507x;":CALC1:PAR:COUN 2"
220    OUTPUT @Agte507x;":CALC1:PAR1:DEF S21"
230    OUTPUT @Agte507x;":CALC1:PAR1:SEL"
240    OUTPUT @Agte507x;":CALC1:FORM MLOG"
250    OUTPUT @Agte507x;":CALC1:PAR2:DEF S11"
260    OUTPUT @Agte507x;":CALC1:PAR2:SEL"
270    OUTPUT @Agte507x;":CALC1:FORM MLOG"
280    !
290    OUTPUT @Agte507x;":DISP:ENAB OFF"
300    OUTPUT @Agte507x;":FORM:DATA REAL"
310    !
320    FOR I=1 TO 10
330        OUTPUT @Agte507x;":TRIG:SING"
340        OUTPUT @Agte507x;":*OPC?"
350        ENTER @Agte507x;Buff$
360        !
370        ! Read Trace Data
380        !
390        OUTPUT @Agte507x;":CALC1:PAR1:SEL"
400        OUTPUT @Agte507x;":CALC1:DATA:FDAT?"
410        ENTER @Agte507x USING "#,8A";Buff$
420        ENTER @Binary;Trace1(*)
430        ENTER @Agte507x USING "#,1A";Buff$
440        !
450        OUTPUT @Agte507x;":CALC1:PAR2:SEL"
460        OUTPUT @Agte507x;":CALC1:DATA:FDAT?"
470        ENTER @Agte507x USING "#,8A";Buff$
480        ENTER @Binary;Trace2(*)
490        ENTER @Agte507x USING "#,1A";Buff$
500        !
510        ! Update Display
520        !
530        OUTPUT @Agte507x;":DISP:UPD"
540    NEXT I
550    END

```

Detecting Occurrence of an Error

Using the status reporting system

The status of the E5061A/E5062A can be detected through the status registers. This section describes how to detect the end of measurement using the status registers. For the complete description of the status report mechanism, including the specifications of each bit, see Appendix B, “Status Reporting System.”

Occurrence of an error will be present in the standard event status register. An SRQ (service request) is useful when you create a program that uses the information reported by this register to detect occurrence of an error.

To detect the end of sweep via an SRQ, use one of the following commands:

- *SRE on page 198
- *ESE on page 195

Follow these steps:

- Step 1.** Set the E5061A/E5062A so that it generates an SRQ when any of the error occurrence bit is set to 1 in the standard event status register.
- Step 2.** When an SRQ is generated, the program interrupts the measurement cycle.

Figure 11-1

SRQ generation sequence (when an error occurs)

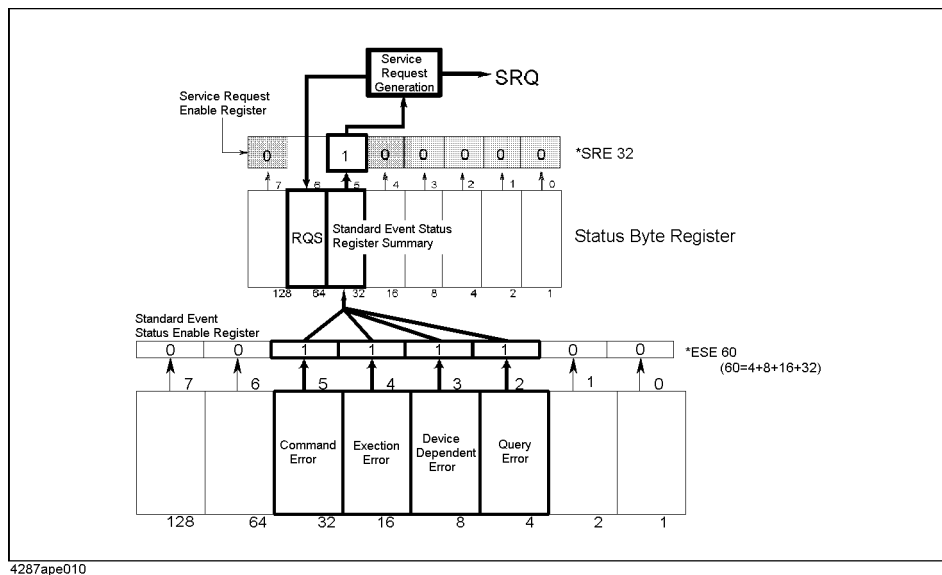

Using the error queue

An error queue holds the number for the error and the error message. Reading the error queue allows the user to verify the error that has been occurred. To retrieve the content of error queue, use the following command:

- :SYST:ERR? on page 474

The error queue can be used in the following ways:

1. It is used as a branch for error handling. When an error queue is retrieved, it returns 0 as the error number and “No error” as the error message if no errors detected. This can be used for detecting of an error and for branching flow of a program. Also this is useful when you wish to handle a specific error(s). Note that this method will not allow the user to perform any processing in synchronization with an occurrence of an error.
2. When an error is detected using SRQ, the error queue is used to examine the error. Refer to the example in Example 11-2.

Sample program

Example 11-2 is a sample program that demonstrates how to use an SRQ to detect occurrence of an error. You can find the source file of this program, named `srq_err.htb`, on the sample program disk.

This program sets SRQs then incidentally send an invalid parameter to generate an error, which is handled by this program. In the error handling part, this program examines the error, displays the error number and error message, and display the message indicating the suspend of the program.

- | | |
|------------------|---|
| Line 40 | Assigns a GPIB address to the I/O pass. |
| Lines 60 to 70 | These lines enables the bit 2, 3 4 and 5 in the standard event status register, and set the bit 5 to 1 in the service request enable register. |
| Lines 80 to 100 | These lines clear the status byte register, the standard event status register, and the error queue. |
| Lines 120 to 130 | These lines set the branch target for an SRQ interrupt to enable SRQ interrupts. |
| Lines 140 to 260 | These lines set the measurement parameters and their data formats for trace 1 and 2. An invalid parameter is given to the data format setting for trace 2, causing an error. |
| Lines 280 to 330 | These lines define an error handler that

Lines 290 to 300: These lines retrieve the error number and error messages for the error from the error queue.

Lines 310 to 330 These lines displays the message indicating occurrence of the error, the error number, the error message, and the message showing that the program is suspend. |
| Line 350 | Displays a closing message. Note that this message will not display unless this program is re-executed after setting a corrected parameter to the data format setting for trace 2. |

Example 11-2 **Error detection using an SRQ (srq_err.bas)**

```
10     DIM Buff$(9),Err_mes$(50)
20     INTEGER Err_no
30     !
40     ASSIGN @Agte507x TO 717
50     !
60     OUTPUT @Agte507x;"*ESE 60"
70     OUTPUT @Agte507x;"*SRE 32"
80     OUTPUT @Agte507x;"*CLS"
90     OUTPUT @Agte507x;"*OPC?"
100    ENTER @Agte507x;Buff$
110    !
120    ON INTR 7 GOTO Err_proc
130    ENABLE INTR 7;2
140    OUTPUT @Agte507x;":CALC1:PAR:COUN 2"
150    PRINT "Trace 1 Meas.Para: S21"
160    PRINT "Trace 1 Format   : Log Mag"
170    OUTPUT @Agte507x;":CALC1:PAR1:DEF S21"
180    OUTPUT @Agte507x;":CALC1:PAR1:SEL"
190    OUTPUT @Agte507x;":CALC1:FORM MLOG"
200    PRINT "Trace 2 Meas.Para: S11"
210    PRINT "Trace 2 Format   : Log Mag"
220    OUTPUT @Agte507x;":CALC1:PAR2:DEF S11"
230    OUTPUT @Agte507x;":CALC1:PAR2:SEL"
240    OUTPUT @Agte507x;":CALC1:FORM LOG"
250    OUTPUT @Agte507x;"*OPC?"
260    ENTER @Agte507x;Buff$
270    GOTO Skip_err_proc
280 Err_proc: OFF INTR 7
290    OUTPUT @Agte507x;";:SYST:ERR?"
300    ENTER @Agte507x;Err_no,Err_mes$
310    PRINT "Error occurred!!"
320    PRINT "  No: ";Err_no,"Description: "&Err_mes$
330    PRINT "PROGRAM INTERRUPT!!"
340    GOTO Prog_end
350 Skip_err_proc: PRINT "PROGRAM DONE."
360 Prog_end: END
```

12 Sample Application Programs

This chapter introduces several sample programs for basic measurement, measurement with a system using the handler I/O, and controlling the instrument over LAN.

Basic measurement (measuring a band pass filter)

Example 12-1 provides a sample program that measures a band pass filter. You can find the source file of this program, named `meas_bpf.htb`, on the sample program disk.

The sample program performs full 2-port calibration using the 85032F calibration kit, measure a band-pass filter (center frequency: 947.5 MHz), and calculates and displays its bandwidth, insertion loss, and so on. This measurement is the same as “Measuring a band pass filter” in *Installation and Quick Start Guide* of the E5061A/E5062A. Therefore, for information on the flow of the measurement, the connection of the standard, and so on, refer to the description of *Installation and Quick Start Guide*.

When started, the program displays the message “Set OPEN to Port 1. Then push [Enter] key.” Connect the OPEN standard to the port 1 and press **[Enter]** to measure the OPEN calibration data. Likewise, connect the SHORT and the LOAD standards and measure each calibration data.

Next, the program displays the message “Set OPEN to Port 2. Then push [Enter] key.” Connect the OPEN standard to the port 2 and press **[Enter]** to measure the OPEN calibration data. Likewise, connect the SHORT and the LOAD standards and measure each calibration data.

Further, the program displays the message “Set THRU between Port 1 and Port 2. Then push [Enter] key.” Connect the THRU standard between the ports 1 and 2 and press **[Enter]** to measure the THRU calibration data.

When the calibration is finished, the program displays the message “Set DUT. Then Push [Enter] key.” Connect the DUT and press **[Enter]**. This initiates the measurement and display the result as shown in Figure 12-1.

Figure 12-2 shows a sample display of the LCD screen after the program exits execution.

Figure 12-1

Sample execution result of the program of Example 12-1

```
## Measurement Result ##  
  BW:      3.63757249908E+7  
 cent:     9.4836227902E+8  
  low:     9.30174417035E+8  
 high:     9.66550142015E+8  
   Q:      26.0712980976  
 loss:     -2.2447956671
```

Figure 12-2

Sample display of the screen after the program Example 12-1 exits execution

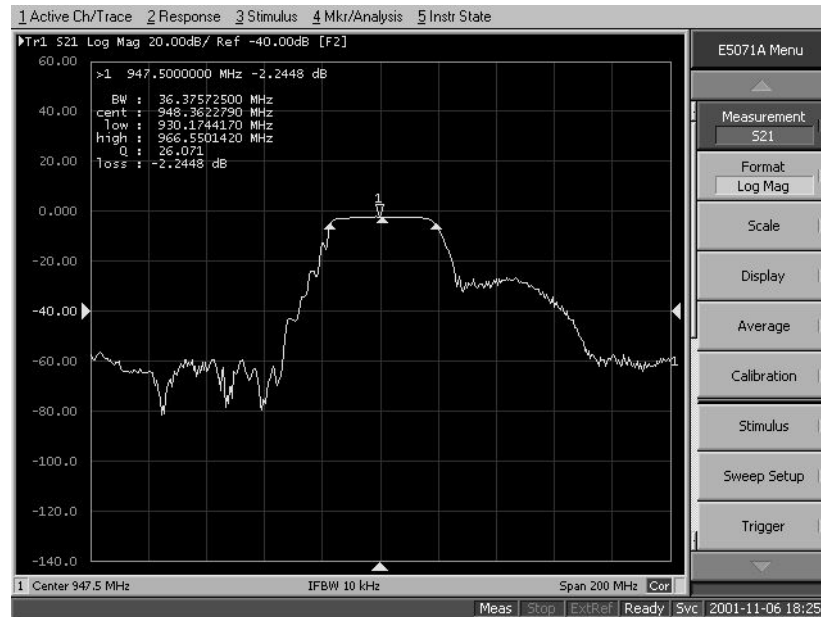

12. Sample Application Programs

The program is described in detail below:

- Line 50 Assigns a GPIB address to the I/O pass.
- Lines 70 to 110 Store the sweep center value (947.5 MHz), the sweep span value (200 MHz), the number of measurement points (401), the IF bandwidth (10 kHz), the power level (-10 dBm) into the variables Center, Span, Nop, If_Bw, and Pow, respectively.
- Lines 120 to 160 Stores the number of traces (1), the measurement parameter (S21), the data format (log Mag), the calibration kit number (4: 85032F), and the save file name (State08.sta) into the variables, Num_of_tr, Para\$, Fmt\$, CalKit, and File\$, respectively.
- Line 200 Puts the instrument into preset state.
- Lines 220 to 260 These lines assign the sweep center value for channel 1 to Center, sweep span value to Span, number of measurement points to Nop, IF bandwidth to If_bw, and power level to Pow, respectively.
- Lines 280 to 310 These lines assign the number of trace for channel 1 to Num_of_tr, measurement parameters to Para\$, and data format to Fmt\$, respectively.
- Line 350 Stores the calibration kit number for channel 1 to the CalKit variable.
- Lines 360 to 380 These lines specifies ports 1 and 2 to be used and calls the sub program Cal_solt to perform full 2-port calibration for channel 1. For more information on the Cal_solt subprogram, refer to the description in Example 4-1 on page 69.
- Lines 420 to 430 Saves the settings of the E5061A/E5062A and the calibration coefficients under the file name File\$.
- Lines 480 to 490 These lines set the trigger source to the bus trigger and turns on the continuous initiation mode for channel 1.

Sample Application Programs

Basic measurement (measuring a band pass filter)

- Lines 510 to 520 These lines prompt the user to connect the DUT and wait for **[Enter]** to be pressed after the DUT is connected.
- Lines 540 to 560 These lines trigger the instrument, and waits until the measurement cycle finishes.
- Line 580 This line executes auto scale for the trace 1 of channel 1.
- Lines 620 to 650 These lines turn on the display of marker 1, move the marker to the position where the stimulus value is equal to Center, read out the response value at the marker and assign the value to the Resp variable.
- Lines 670 to 710 These lines configure the system to generate an SRQ when it cannot perform Bandwidth Search due to an error.
- Lines 730 to 740 These lines set the branch target for an SRQ interrupt to enable SRQ interrupts.
- Lines 750 to 790 Sets the bandwidth definition value to -3 dB and the bandwidth search result display to on, reads out the bandwidth search results (bandwidth, center frequency, Q value, and insertion loss), and stores them into the variables Bwid, Cent, Q, and Loss, respectively.
- Lines 830 to 900 These lines define an error handler that retrieves the error number and error messages for the error, then assign 0 to Bwid, Cent and Q, Resp (response value at marker 1) to Loss.
- Lines 930 to 940 These lines calculate the 2 (higher and lower) cutoff frequencies from the values in the Bw and Cent variables and stores them into the Cut_l and Cut_h variables.
- Lines 980 to 1040 These lines display the measurement results (values of Bwid, Cent, Q, Loss, Cut_l, and Cut_h).
- Lines 1060 to 1070 These lines prompt the user to decide to perform another measurement. When **[y]** is pressed followed by **[Enter]** key, the program will return to the part where the DUT is connected and continue measurement.

Example 12-1

Measurement of band pass filter (meas_bpf.htb)

```

10 DIM Para$[9],Fmt$[9],File$[20],Buff$[9],Inp_char$[9],Err_msg$[20]
20 REAL Center,Span,If_bw,Pow,Resp,Bwid,Cent,Q,Loss,Cut_l,Cut_h
30 INTEGER Nop,Num_of_tr,Cal_kit,Port(1:4),Err_no
40 !
50 ASSIGN @Agte507x TO 717
60 !
70 Center=9.475E+8 ! Center Freq. : 947.5 MHz
80 Span=2.00E+8 ! Span : 200 MHz
90 Nop=401 ! Number of Points : 401
100 If_bw=1.0E+4 ! IF Bandwidth : 10 kHz
110 Pow=-10 ! Power Level : -10 dBm
120 Num_of_tr=1 ! Number of Traces : 1
130 Para$="S21" ! Meas. Parameter : S21
140 Fmt$="MLOG" ! Data Format : Log Mag
150 Cal_kit=4 ! Calibration Kit : 85032F
160 File$="State08.sta" ! Save File Name : State08.sta
170 !
180 ! Measurement Condition
190 !
200 OUTPUT @Agte507x;":SYST:PRES"
210 !
220 OUTPUT @Agte507x;":SENS1:FREQ:CENT ";Center
230 OUTPUT @Agte507x;":SENS1:FREQ:SPAN ";Span
240 OUTPUT @Agte507x;":SENS1:SWE:POIN ";Nop
250 OUTPUT @Agte507x;":SENS1:BAND ";If_bw
260 OUTPUT @Agte507x;":SOUR1:POW ";Pow
270 !
280 OUTPUT @Agte507x;":CALC1:PAR:COUN ";Num_of_tr
290 OUTPUT @Agte507x;":CALC1:PAR1:DEF "&Para$"
300 OUTPUT @Agte507x;":CALC1:PAR1:SEL"
310 OUTPUT @Agte507x;":CALC1:FORM "&Fmt$"
320 !
330 ! Full 2 Port Calibration (@ Port 1 & Port 2)
340 !
350 OUTPUT @Agte507x;":SENS1:CORR:COLL:CKIT ";Cal_kit
360 Port(1)=1
370 Port(2)=2
380 Cal_solt(@Agte507x,"1",2,Port(*))
390 !
400 ! Save State & Cal
410 !
420 OUTPUT @Agte507x;":MMEM:STOR:STYP CST"
430 OUTPUT @Agte507x;":MMEM:STOR ""&File$&""
440 !
450 ! Measurement
460 !
470 CLEAR SCREEN
480 OUTPUT @Agte507x;":TRIG:SOUR BUS"
490 OUTPUT @Agte507x;":INIT1:CONT ON"
500 Meas_start:~
510 PRINT "Set DUT, then Push [Enter] key"
520 INPUT "",Inp_char$
530 !
540 OUTPUT @Agte507x;":TRIG:SING"
550 OUTPUT @Agte507x;":*OPC?"
560 ENTER @Agte507x;Buff$
570 !
580 OUTPUT @Agte507x;":DISP:WIND1:TRAC1:Y:AUTO"
590 !
600 ! Analysis
610 !

```

Sample Application Programs

Basic measurement (measuring a band pass filter)

```
620 OUTPUT @Agte507x;":CALC1:MARK1 ON"
630 OUTPUT @Agte507x;":CALC1:MARK1:X ";Center
640 OUTPUT @Agte507x;":CALC1:MARK1:Y?"
650 ENTER @Agte507x;Resp
660 !
670 OUTPUT @Agte507x;"*ESE 60"
680 OUTPUT @Agte507x;"*SRE 32"
690 OUTPUT @Agte507x;"*CLS"
700 OUTPUT @Agte507x;"*OPC?"
710 ENTER @Agte507x;Buff$
720 !
730 ON INTR 7 GOTO Bw_err
740 ENABLE INTR 7;2
750 OUTPUT @Agte507x;":CALC1:MARK1:BWID:THR -3"
760 OUTPUT @Agte507x;":CALC1:MARK1:BWID ON"
770 OUTPUT @Agte507x;":CALC1:MARK1:BWID:DATA?"
780 WAIT .5
790 ENTER @Agte507x;Bwid,Cent,Q, Loss
800 GOTO Skip_bw_err
810 !
820 Bw_err: OFF INTR 7
830 OUTPUT @Agte507x;":SYST:ERR?"
840 ENTER @Agte507x;Err_no,Err_msg$
850 PRINT "Error occurred!!"
860 PRINT " No: ";Err_no, "Description: "&Err_msg$
870 Bwid=0
880 Cent=0
890 Q=0
900 Loss=Resp
910 !
920 Skip_bw_err: OFF INTR 7
930 Cut_l=Cent-(Bwid/2)
940 Cut_h=Cent+(Bwid/2)
950 !
960 ! Display
970 !
980 PRINT "## Measurement Result ##"
990 PRINT " BW:",Bwid
1000 PRINT " cent:",Cent
1010 PRINT " low:",Cut_l
1020 PRINT " high:",Cut_h
1030 PRINT " Q:",Q
1040 PRINT " loss:",Loss
1050 !
1060 INPUT "Once more? [Y]es/[N]o",Inp_char$
1070 IF UPC$(Inp_char$)="Y" OR UPC$(Inp_char$)="YES" THEN Meas_start
1080 !
1090 END
1100 !=====
1110 ! Full n Port Calibration Function
1120 !=====
1130 SUB Cal_solt(@Agte507x,Ch$,INTEGER Num_of_ports,INTEGER Port(*))
1140 DIM Buff$(9)
1150 INTEGER I,J
1160 !
1170 PRINT "## Full "&VAL$(Num_of_ports)&" Port Calibration ##"
1180 !
1190 ! Calibration Type Selection
1200 !
1210 OUTPUT @Agte507x;":SENS"&Ch$&":CORR:COLL:METH:SOLT"&VAL$(Num_of_
ports)&" ";
1220 FOR I=1 TO Num_of_ports-1
1230 OUTPUT @Agte507x;Port(I);", ";
1240 NEXT I
```

```

1250 OUTPUT @Agte507x;Port(Num_of_ports)
1260 !
1270 ! Reflection Measurement
1280 !
1290 FOR I=1 TO Num_of_ports
1300 PRINT "Set OPEN to Port "&VAL$(Port(I))&". Then push [Enter]
key."
1310 INPUT "",Buff$
1320 OUTPUT @Agte507x;":SENS"&Ch$&":CORR:COLL:OPEN ";Port(I)
1330 OUTPUT @Agte507x;"*OPC?"
1340 ENTER @Agte507x;Buff$
1350 PRINT "Set SHORT to Port "&VAL$(Port(I))&". Then push [Enter]
key."
1360 INPUT "",Buff$
1370 OUTPUT @Agte507x;":SENS"&Ch$&":CORR:COLL:SHOR ";Port(I)
1380 OUTPUT @Agte507x;"*OPC?"
1390 ENTER @Agte507x;Buff$
1400 PRINT "Set LOAD to Port "&VAL$(Port(I))&". Then push [Enter]
key."
1410 INPUT "",Buff$
1420 OUTPUT @Agte507x;":SENS"&Ch$&":CORR:COLL:LOAD ";Port(I)
1430 OUTPUT @Agte507x;"*OPC?"
1440 ENTER @Agte507x;Buff$
1450 NEXT I
1460 !
1470 ! Transmission Measurement
1480 !
1490 FOR I=1 TO Num_of_ports-1
1500 FOR J=I+1 TO Num_of_ports
1510 PRINT "Set THRU between Port "&VAL$(Port(I))&" and Port "&
VAL$(Port(J))&". Then push [Enter] key."
1520 INPUT "",Buff$
1530 OUTPUT @Agte507x;":SENS"&Ch$&":CORR:COLL:THRU ";Port(I);", "
;Port(J)
1540 OUTPUT @Agte507x;"*OPC?"
1550 ENTER @Agte507x;Buff$
1560 OUTPUT @Agte507x;":SENS"&Ch$&":CORR:COLL:THRU ";Port(J);", "
;Port(I)
1570 OUTPUT @Agte507x;"*OPC?"
1580 ENTER @Agte507x;Buff$
1590 NEXT J
1600 NEXT I
1610 !
1620 ! Done
1630 !
1640 OUTPUT @Agte507x;":SENS"&Ch$&":CORR:COLL:SAVE"
1650 PRINT "Done"
1660 SUBEND

```

Controlling Using SICL-LAN Server

This section describes how to control the E5061A/E5062A using SICL in the Windows environment, with a sample program (a VBA macro for Microsoft Excel) written in Visual Basic. The source file of this program, ctrl_lansicl.xls, is available in the sample program disk.

NOTE

To control the E5061A/E5062A using the SICL-LAN server, you need to make preparations described in “Control over SICL-LAN server” on page 28.

Using VBA macro

Opening ctrl_lansicl.xls in Microsoft Excel display a screen as shown in Figure 12-3.

Figure 12-3

ctrl_lansicl.xls

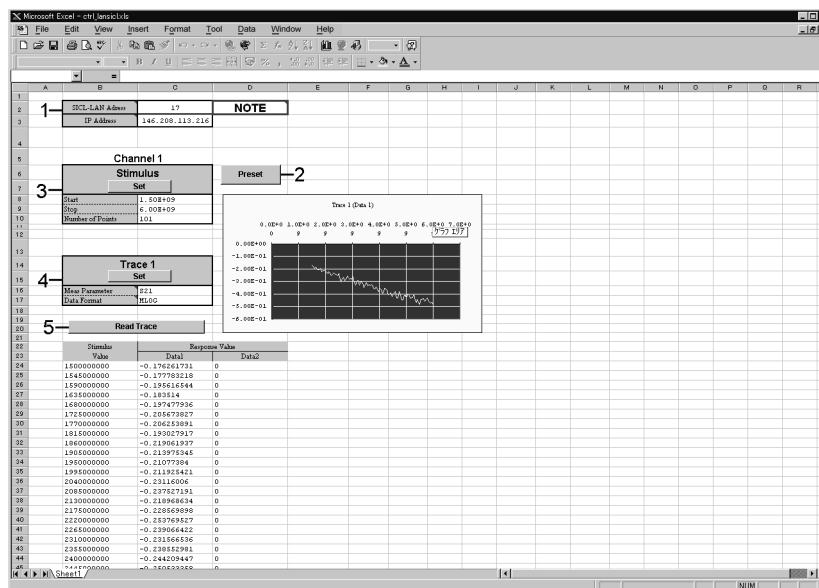

For how to use each element in Figure 12-3, refer to the following description.

We begin describing the part 1. In the cell to the right of SICL-LAN Address, enter the address of the E5061A/E5062A for control with the SICL-LAN server. This address is **xx**, which has been set with the command **[System] - Misc Setup - Network Setup - SICL-LAN Address [xx]**. Enter the IP address of the E5061A/E5062A in the cell right side of IP Address. This VBA macro will not work properly without appropriate values in the two cells.

Clicking the button labeled as Preset in the part 2 executes the presetting operation.

In the part 3, sweep range (start and stop points) and number of measurement points for channel 1 are set. Clicking the button labeled as Set executes the setting as shown in the setting table.

The part 4 set the measurement parameters and data format for trace 1 in channel 1.

Clicking the button labeled as Set executes the setting as shown in the setting table.

Clicking the button labeled as Read Trace in the part 5 retrieves the formatted data array of trace 1 in channel 1 and displays it in tabular and graphical formats.

Description of operation in VBA macro

Here described is operation of the VBA macro, focusing on the part related to controlling with SICL.

In order to use SICL in your VBA macro, you must declare functions and define variables with a definition file of SICL (for VB). In the VBA macro, ctrl_sicllan.xls, the standard module whose object name is “SICL” is the definition file.

Basic control flow with SICL is shown in Figure 12-4.

NOTE

In this sample program, the **ivprintf** function, the **ivscanf** function, and the **iread** function are used in its communication part; you can use other SICL functions as well. For detail, refer to `sicl.hlp` (the online help of SICL).

Figure 12-4

Flow of control using SICL

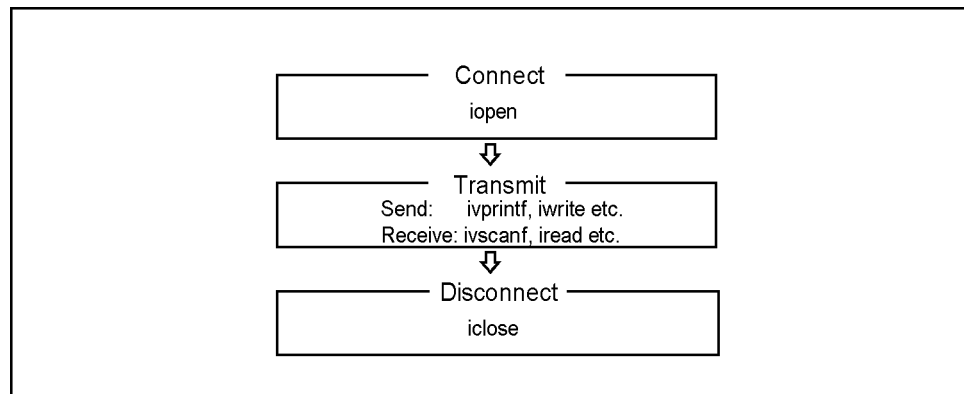

e5070bpe041

NOTE

For more information on how to use each function of SICL, refer to the manual of SICL.

Sample Application Programs
Controlling Using SICL-LAN Server

Procedures in each step in Figure 12-4 are described below.

Connection

The procedure corresponding to connection is `OpenSession` (Example 12-2). `OpenSession` establishes connection to the E5061A/E5062A with the **`iopen`** function of SICL, using SICL-LAN Address and IP Address entered in the part 1 in Figure 12-3. The **`iopen`** function takes the address information of the E5061A/E5062A you specify as its parameters.

Syntax

`addr = iopen(dev)`

Variable

	<i>addr</i>
Description	Session information (output)
Data type	Integer type

	<i>dev</i>
Description	Address information of the instrument you specify (input)
Data type	Character string type
Grammar	<i>sicl-name</i> *1 [<i>ip-address</i> *2]: <i>interface</i> *3, <i>sicl-lan-address</i> *4

- *1. The SICL interface name you have set with the Agilent I/O Libraries in external control.
- *2. The IP address of the E5061A/E5062A.
- *3. For the E5061A/E5062A, specify `hpib9`.
- *4. The address of the E5061A/E5062A for control with the SICL-LAN server.

For example, if the parameter (*dev*) is `"lan[128.10.0.3]:hpib9,17,"` connection is made to the address of **17** of the interface of **hpib9** with the E5061A/E5062A whose IP address is **128.10.0.3** using the external controller whose SICL interface name is **lan**.

Example 12-2

OpenSession

Function `OpenSession()` As Integer

```

Dim ServAddr As String
Dim IpAddr As String

On Error GoTo ErrHandler

'''Get Sicl-Lan Address
Sheets("Sheet1").Select
Range("C2").Select
ServAddr = ActiveCell.FormulaR1C1

'''Get Ip Address
Sheets("Sheet1").Select
Range("C3").Select
IpAddr = ActiveCell.FormulaR1C1

OpenSession = iopen("lan[" & IpAddr & "]:hpib9," & ServAddr)

```



```

Call itimeout(OpenSession, 10000)
Exit Function

ErrorHandler:
MsgBox "*** Error : " & Error$
Call siclcleanup
End

End Function

```

Sending

The procedure corresponding to sending in communication is OutputSicLan (Example 12-3). OutputSicLan uses the **ivprintf** function of SICL to send messages (SCPI commands). The **ivprintf** function takes the session information outputted from the **iopen** function and a program message as its parameters.

Syntax

Status = ivprintf(*addr*; *mes*)

Variable

Table 12-1

Variable (*Status*)

	<i>Status</i>
Description	Return value of the function (output)
Data type	Integer type

Table 12-2

Variable (*addr*)

	<i>addr</i>
Description	Session information (input)
Data type	Integer type

	<i>mes</i>
Description	Program message (input) ^{*1}
Data type	Character string type

*1. When sending a program message of a SCPI command, add the message terminator at the end of the message (in Example 12-3, Chr\$(10)).

Example 12-3

OutputSicLan

```

Sub OutputSicLan(addr As Integer, message As String)

Dim Status As Integer
Dim actualcnt As Long
Dim length As Long

On Error GoTo ErrorHandler

length = Len(message)

```

Sample Application Programs

Controlling Using SICL-LAN Server

```

    Status = ivprintf(addr, message & Chr$(10))
    Exit Sub

ErrorHandler:
    MsgBox "*** Error : " & Error$
    Call siclcleanup
    End

End Sub

```

Receiving

The procedure corresponding to receiving ASCII format messages in communication is EnterSicLan (Example 12-4). EnterSicLan uses the **ivscanf** function of SICL to receive a message in ASCII format and store it into the output variable. The **ivscanf** function takes the session information outputted from the **iopen** function, the format for output, and data to be outputted as its parameters.

Syntax

Status = ivscanf(*addr*,*fmt*,*ap*)

Variable

	<i>fmt</i>
Description	Format for output (input)
Data type	Character string type

	<i>ap</i>
Description	Data to be outputted (output)
Data type	Character string type

For information on the variable (*Status*) and the variable (*addr*), refer to Table 12-1, “Variable (Status),” on page 177 and Table 12-2, “Variable (addr),” on page 177, respectively.

NOTE

In Visual Basic, variables must be declared as a fixed length string when receiving string data using the **ivscanf** function.

Example 12-4

EnterSicLan

```

Sub EnterSicLan(addr As Integer, Query As String)

    Dim Status As Integer
    Dim actualcnt As Long
    Dim res As String * 256

    On Error GoTo ErrorHandler

    Status = ivscanf(addr, "%t", res)
    Query = Trim(res)
    Exit Sub

```

```

ErrHandler:
  MsgBox "**** Error : " & Error$
  Call siclcleanup
  End
End Sub

```

The procedure corresponding to receiving array data in communication is EnterSicLanArrayReal64 (Example 12-5). EnterSicLanArrayReal64 uses the **iread** function of SICL to receive array data in the IEEE 64 bit floating point binary transfer format and store it into the output variable. The **iread** function takes the session information outputted from the **iopen** function, data to be outputted, the number of data bytes, the condition to finish reading data, and the number of data bytes actually read out as its parameters.

Syntax

Status = iread(*addr;buf,bufsize,reason,actual*)

Variable

	<i>buf</i>
Description	Data to be outputted (output)
Data type	Character string type

	<i>bufsize</i>
Description	The number of data bytes (input)
Data type	Long integer type

	<i>reason</i>
Description	The condition to finish reading out data (input)
Data type	Integer type

	<i>actual</i>
Description	The number of data bytes actually read out (output)
Data type	Long integer type

For information on the variable (*Status*) and the variable (*addr*), refer to Table 12-1, “Variable (Status),” on page 177 and Table 12-2, “Variable (addr),” on page 177, respectively.

Each functional part of EnterSicLanArrayReal64 is described below.

- (1) retrieves the data header.
- (2) stores the number of data bytes into the size variable in the header part.
- (3) retrieves the formatted data array for trace 1 in channel 1, and stores it into the databuf variable.

Sample Application Programs

Controlling Using SICL-LAN Server

(4) retrieves the message terminator at the end of the data.

Example 12-5

EnterSicLanArrayReal64

```
Function EnterSicLanArrayReal64(addr As Integer, databuf() As Double)
As Long

    Dim Status As Integer
    Dim actualcnt As Long
    Dim buf As String * 8
    Dim size As Long

    On Error GoTo ErrHandler

    '''Read header info of "#6NNNNNN"
    Status = iread(addr, buf, 8, I_TERM_MAXCNT, actualcnt)
'.....(1)

    size = Val(Mid$(buf, 3, 6))
'.....(2)

    '''Read data
    Status = iread(addr, databuf, size, I_TERM_MAXCNT, actualcnt)
'.....(3)

    '''Read ending LF
    Status = iread(addr, buf, 1, I_TERM_MAXCNT, actualcnt)
'.....(4)

    EnterSicLanArrayReal64 = size / 8
    Exit Function

ErrHandler:
    MsgBox "*** Error : " & Error$
    Call siclcleanup
    End

End Function
```

Disconnection

The **iclose** function of SICL is used to disconnect communication. The **iclose** function takes the session information outputted from the **iopen** function as its parameter.

Syntax

Status = iclose(*addr*)

For information on the variable (*Status*) and the variable (*addr*), refer to Table 12-1, “Variable (*Status*),” on page 177 and Table 12-2, “Variable (*addr*),” on page 177, respectively.

Sample control

The E5061A/E5062A can be controlled by executing the above procedures in order, following the control flow in Figure 12-4. This is demonstrated by the procedure Preset (a procedure which is executed when the Preset button is clicked) as described in Example 12-6.

Example 12-6

Preset

```
Sub Preset()  
  
    ''' Open Session  
    E507x = OpenSession  
  
    '''Presetting the analyzer  
    Call OutputSiclLan(E507x, ":SYST:PRES")  
  
    '''Close Session  
    Call iclose(E507x)  
  
End Sub
```

Controlling Using Telnet Server

This section describes how to control the E5061A/E5062A using WinSock API in the Windows environment, with a sample program written in Visual Basic (VBA macro). You can find the source file of this program, named ctrl_lan.xls (Microsoft Excel file), on the sample program disk.

Using VBA macro

Opening ctrl_lan.xls in Microsoft Excel display a screen as shown in Figure 12-5.

Figure 12-5

ctrl_lan.xls

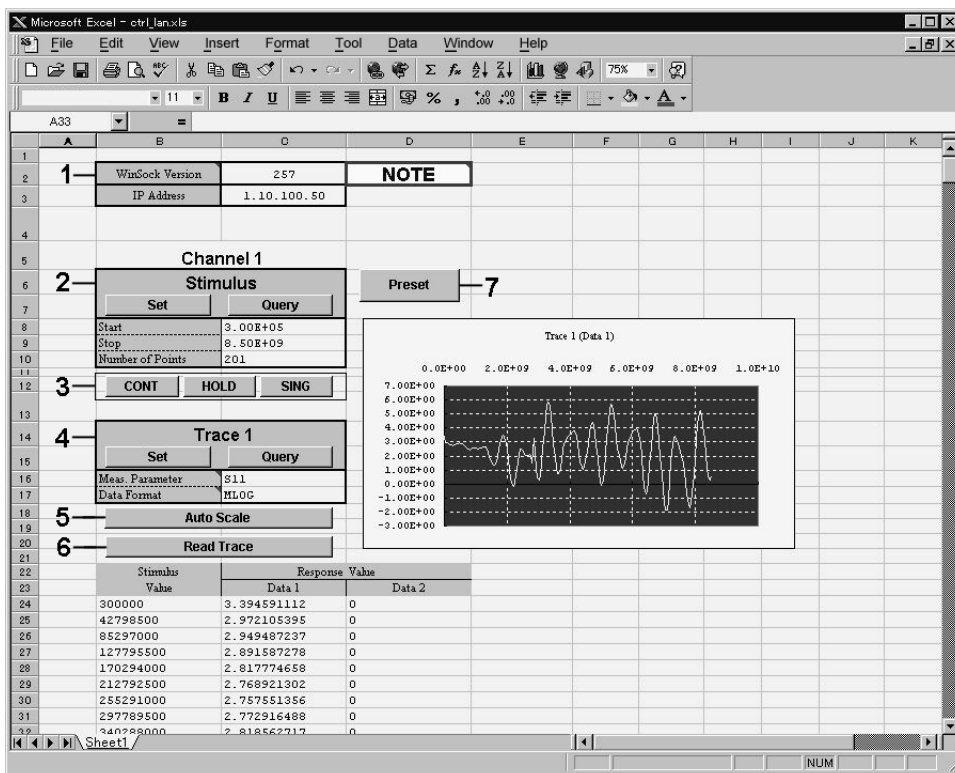

e5070ape024

For how to use each element in Figure 12-5, refer to the following description.

We begin describing the part 1. Enter the version number of WinSock API in the cell right side of “Winsock Version.” The version number is obtained by multiplying 256 by the major version then adding the minor version. For example, when the version of your Winsock API is 1.1, the version number is obtained as follows: $256 \times 1 + 1 = 257$. Enter the IP address of the E5061A/E5062A in the cell right side of “IP Address.” This VBA macro will not work properly without appropriate values in the two cells.

In the part 2, sweep range (start and stop points) and number of measurement points are set. Clicking the button labeled as “Set” executes setting operation as specified with the setting table, while clicking the button labeled as “Query” retrieves the current settings of the E5061A/E5062A.

The part 3 is dedicated to setting the trigger mode.

The part 4 set the measurement parameters and data format for trace 1 in channel 1. Clicking the button labeled as ‘Set’ executes setting operation as specified with the setting table, while clicking the button labeled as ‘Query’ retrieves the current settings of the E5061A/E5062A.

In the part 5, clicking the button labeled as ‘Auto Scale’ executes auto scaling for trace 1 in channel 1.

Clicking the button labeled as ‘Read Trace’ in the part 6 retrieves the formatted data of trace 1 in channel 1 and displays it in tabular and graphical formats.

Clicking the button labeled as ‘Preset’ executes the presetting operation.

Description of operation in VBA macro

Here described is operation of the VBA macro, focusing on the part related to controlling with WinSock API.

In order to use WinSock API, you must declare functions and define variables with a definition file of WinSock API, as shown in Example 12-7.

Example 12-7

Definition file of WinSock API

```
'This is the Winsock API definition file for Visual Basic

'Setup the variable type 'hostent' for the WSStartup command
Type Hostent
    h_name As Long
    h_aliases As Long
    h_addrtype As String * 2
    h_length As String * 2
    h_addr_list As Long
End Type
Public Const SZHOSTENT = 16

'Set the Internet address type to a long integer (32-bit)
Type in_addr
    s_addr As Long
End Type

'A note to those familiar with the C header file for Winsock
'Visual Basic does not permit a user-defined variable type
'to be used as a return structure. In the case of the
'variable definition below, sin_addr must
'be declared as a long integer rather than the user-defined
'variable type of in_addr.
Type sockaddr_in
    sin_family As Integer
    sin_port As Integer
    sin_addr As Long
    sin_zero As String * 8
End Type

Public Const WSADESCRIPTION_LEN = 256
Public Const WSASYS_STATUS_LEN = 128
Public Const WSA_DescriptionSize = WSADESCRIPTION_LEN + 1
Public Const WSA_SysStatusSize = WSASYS_STATUS_LEN + 1
```

Sample Application Programs

Controlling Using Telnet Server

```
'Setup the structure for the information returned from
'the WSASocket() function.
Type WSADATA
  wVersion As Integer
  wHighVersion As Integer
  szDescription As String * WSA_DescriptionSize
  szSystemStatus As String * WSA_SysStatusSize
  iMaxSockets As Integer
  iMaxUdpDg As Integer
  lpVendorInfo As String * 200
End Type

'Define socket return codes
Public Const INVALID_SOCKET = &HFFFF
Public Const SOCKET_ERROR = -1

'Define socket types
Public Const SOCK_STREAM = 1           'Stream socket
Public Const SOCK_DGRAM = 2           'Datagram socket
Public Const SOCK_RAW = 3             'Raw data socket
Public Const SOCK_RDM = 4             'Reliable Delivery socket
Public Const SOCK_SEQPACKET = 5       'Sequenced Packet socket

'Define address families
Public Const AF_UNSPEC = 0             'unspecified
Public Const AF_UNIX = 1              'local to host (pipes, portals)
Public Const AF_INET = 2              'internet: UDP, TCP, etc.
Public Const AF_IMPLINK = 3          'arpanet imp addresses
Public Const AF_PUP = 4               'pup protocols: e.g. BSP
Public Const AF_CHAOS = 5             'mit CHAOS protocols
Public Const AF_NS = 6                'XEROX NS protocols
Public Const AF_ISO = 7               'ISO protocols
Public Const AF_OSI = AF_ISO          'OSI is ISO
Public Const AF_ECMA = 8              'european computer manufacturers
Public Const AF_DATAKIT = 9           'datakit protocols
Public Const AF_CCITT = 10            'CCITT protocols, X.25 etc
Public Const AF_SNA = 11              'IBM SNA
Public Const AF_DECnet = 12           'DECnet
Public Const AF_DLI = 13              'Direct data link interface
Public Const AF_LAT = 14              'LAT
Public Const AF_HYLINK = 15           'NSC Hyperchannel
Public Const AF_APPLETALK = 16        'AppleTalk
Public Const AF_NETBIOS = 17          'NetBios-style addresses
Public Const AF_MAX = 18              'Maximum # of address families

'Setup sockaddr data type to store Internet addresses
Type sockaddr
  sa_family As Integer
  sa_data As String * 14
End Type
Public Const SADDRLEN = 16

'Declare Socket functions

Public Declare Function closesocket Lib "wsock32.dll" (ByVal s As Long)
As Long

Public Declare Function connect Lib "wsock32.dll" (ByVal s As Long, addr
As sockaddr_in, ByVal namelen As Long) As Long
```



```

Public Declare Function htons Lib "wsck32.dll" (ByVal hostshort As Long)
As Integer

Public Declare Function inet_addr Lib "wsck32.dll" (ByVal cp As String)
As Long

Public Declare Function recv Lib "wsck32.dll" (ByVal s As Long, ByVal
buf As Any, ByVal buflen As Long, ByVal flags As Long) As Long

Public Declare Function recvB Lib "wsck32.dll" Alias "recv" (ByVal s As
Long, buf As Any, ByVal buflen As Long, ByVal flags As Long) As Long

Public Declare Function send Lib "wsck32.dll" (ByVal s As Long, buf As
Any, ByVal buflen As Long, ByVal flags As Long) As Long

Public Declare Function socket Lib "wsck32.dll" (ByVal af As Long, ByVal
socktype As Long, ByVal protocol As Long) As Long

Public Declare Function WSASStartup Lib "wsck32.dll" (ByVal
wVersionRequired As Long, lpWSAData As WSAData) As Long

Public Declare Function WSACleanup Lib "wsck32.dll" () As Long

Public Declare Function WSAUnhookBlockingHook Lib "wsck32.dll" () As
Long

Public Declare Sub CopyMemory Lib "kernel32" Alias "RtlMoveMemory"
(hpvDest As Any, hpvSource As Any, ByVal cbCopy As Long)

```

Basic control flow with WinSock API is shown in Figure 12-6.

Figure 12-6

Control flow with WinSock API

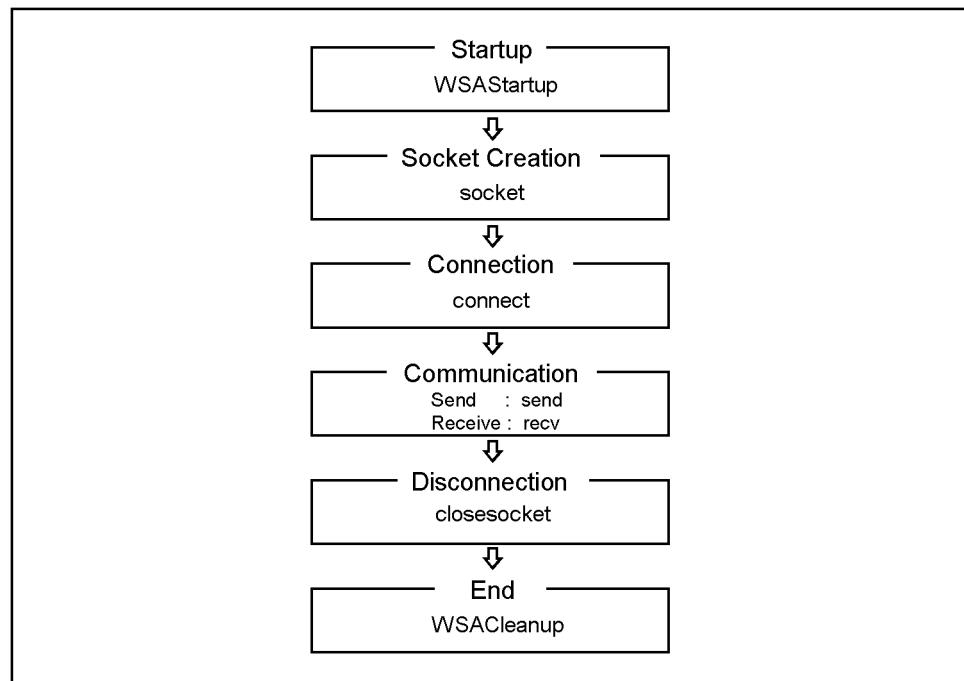

e5070ape029

Sample Application Programs

Controlling Using Telnet Server

Procedures in each step in Figure 12-6 are described below.

Startup

The procedure corresponding to Startup is StartIt (Example 12-8). StartIt launches and initialize WinSock API with **WSAStartup** in WinSock API, whose version is in the part 1 of Figure 12-5. The function WSAStartup should be always used when initiating WinSock. This function takes version number (input) and launching information (output) as its parameters.

Example 12-8

StartIt

```
Sub StartIt()  
  
    Dim StartUpInfo As WSADATA  
  
    'Version 1.1 (1*256 + 1) = 257  
    'version 2.0 (2*256 + 0) = 512  
  
    'Get WinSock version  
    Sheets("Sheet1").Select  
    Range("C2").Select  
    version = ActiveCell.FormulaR1C1  
  
    'Initialize Winsock DLL  
    x = WSAStartup(version, StartUpInfo)  
  
End Sub
```

Socket Creation and Connection

The procedure for Socket Creation and Connection is OpenSocket (Example 12-9). OpenSocket makes a connection to an instrument associated with the IP address specified with the input parameter Hostname. It uses a socket of the port specified with the input parameter PortNumber. Each functional part of OpenSocket is described below.

In (1), the inet_addr function of WinSock API is used to convert an IP address delimited by “.” to an Internet address.

In (2), a new socket is created with **socket** function of WinSock API and its socket descriptor is obtained. If an error occurs, the control returns to the main program with a message. socket function takes parameters for an address family (input), a socket type (input), and a protocol number (input).

In (3), the socket address is specified. Note that htons, which is used for specifying the port number, is a function of WinSock API. The function converts a 2-byte integer from the Windows byte order (little endian) to the network byte order (big endian).

In (4), a connection to the E5061A/E5062A is made using **connect** function of WinSock API. If an error occurs, the control returns to the main program with a message. connect function takes parameters for a socket descriptor (input), a socket address (input), and size of the socket address (input).

Example 12-9 OpenSocket

```
Function OpenSocket(ByVal Hostname As String, ByVal PortNumber As Integer) As Integer

    Dim I_SocketAddress As sockaddr_in
    Dim ipAddress As Long

    ipAddress = inet_addr(Hostname) '..... (1)

    'Create a new socket
    socketId = socket(AF_INET, SOCK_STREAM, 0) '
    If socketId = SOCKET_ERROR Then '
        MsgBox ("ERROR: socket = " + Str$(socketId)) '..... (2)
        OpenSocket = COMMAND_ERROR '
        Exit Function '
    End If '

    'Open a connection to a server

    I_SocketAddress.sin_family = AF_INET '
    I_SocketAddress.sin_port = htons(PortNumber) '..... (3)
    I_SocketAddress.sin_addr = ipAddress '
    I_SocketAddress.sin_zero = String$(8, 0) '

    x = connect(socketId, I_SocketAddress, Len(I_SocketAddress)) '
    If socketId = SOCKET_ERROR Then '
        MsgBox ("ERROR: connect = " + Str$(x)) '.. (4)
        OpenSocket = COMMAND_ERROR '
        Exit Function '
    End If '

    OpenSocket = socketId

End Function
```

Communication

The procedure corresponding to Communication is SendCommand (Example 12-10). SendCommand transmits a message (SCPI command) specified with the input parameter “command” to the E5061A/E5062A using **send** function of WinSock API. send function takes parameters for a socket descriptor (input), a message to be transmitted (input), message length (input) and a flag (input).

Example 12-10 SendCommand

```
Function SendCommand(ByVal command As String) As Integer

    Dim strSend As String

    strSend = command + vbCrLf

    count = send(socketId, ByVal strSend, Len(strSend), 0)

    If count = SOCKET_ERROR Then
        MsgBox ("ERROR: send = " + Str$(count))
        SendCommand = COMMAND_ERROR
        Exit Function
    End If

    SendCommand = NO_ERROR

End Function
```

Sample Application Programs

Controlling Using Telnet Server

End Function

The procedure corresponding to a receiving part of communication is `RecvAscii` (Example 12-11) and other functions. `RecvAscii` receives a message as ASCII format and stores it in the `dataBuf` output parameter. Maximum length of the message is specified with the `maxLength` input parameter. Each functional part of `RecvAscii` is described below.

In (1), a message (a response to a query for SCPI command) is received from the E5061A/E5062A as a series of characters using `recv` function of `WinSock` API. If an error occurs, the control returns to the main program with a message. `recv` function takes parameters for a socket descriptor (input), a message to be received (input), message length (input) and a flag (input).

In (2), it is determined whether each received character is LF (ASCII code: 10). When it is LF, receiving is terminated adding NULL (ASCII code: 0) to the end of `dataBuf` string and the control returns to the main program.

In (3), number of the last characters that was read out is added to the count value for checking a number of received characters, and append the characters to the end of `dataBuf` string.

Example 12-11

`RecvAscii`

```
Function RecvAscii(dataBuf As String, ByVal maxLength As Integer) As Integer

    Dim c As String * 1
    Dim length As Integer

    dataBuf = ""
    While length < maxLength
        DoEvents
        count = recv(socketId, c, 1, 0)
        If count < 1 Then
            RecvAscii = RECV_ERROR
            dataBuf = Chr$(0)
            Exit Function
        End If

        If c = Chr$(10) Then
            dataBuf = dataBuf + Chr$(0)
            RecvAscii = NO_ERROR
            Exit Function
        End If

        length = length + count
        dataBuf = dataBuf + c
    Wend

    RecvAscii = RECV_ERROR

End Function
```

Disconnection

The procedure corresponding to Disconnection is CloseConnection (Example 12-12). CloseConnection disconnects communication and removes a socket using **closesocket** function of WinSock API. closesocket function takes a parameter for a socket descriptor (input).

Example 12-12

CloseConnection

```
Sub CloseConnection()  
  
    x = closesocket(socketId)  
  
    If x = SOCKET_ERROR Then  
        MsgBox ("ERROR: closesocket = " + Str$(x))  
        Exit Sub  
    End If  
  
End Sub
```

End

The procedure corresponding to End is EndIt (Example 12-13). EndIt disconnects WinSock API using **WSACleanup** function of WinSock API. The function WSACleanup should be always used when terminating WinSock.

Example 12-13

EndIt

```
Sub EndIt()  
  
    'Shutdown Winsock DLL  
    x = WSACleanup()  
  
End Sub
```

Example of control

The E5061A/E5062A can be controlled by executing the above procedures in order, following the control flow in Figure 12-6. This is demonstrated by the procedure autoscale (a procedure which is executed when the Auto Scale button is clicked) as described in Example 12-14.

Example 12-14

autoscale

```
Sub autoscale()  
'  
' auto scaling  
'  
    Call StartIt  
    Call get_hostname  
    x = OpenSocket(Hostname$, ScpiPort)  
  
    x = SendCommand(":DISP:WIND1:TRAC1:Y:AUTO")  
  
    Call CloseConnection  
    Call EndIt  
  
End Sub
```

NOTE

When you execute more than one command by connecting and disconnecting a socket for every command, the sequence of execution may change.

Connection → Command 1 → Command 2 → Disconnection

Commands 1 and 2 are always executed in this sequence.

Connection → Command 1 → Disconnection → Connection → Command 2 → Disconnection

These commands may be in the sequence of Command 2 → command 1.

13 SCPI Command Reference

This chapter describes the SCPI command reference for the Agilent E5061A/E5062A. It describes the commands using their abbreviated format in alphabetical order. If you want to look up commands by softkeys, refer to the User's Guide.

Notational conventions in this command reference

This section describes the rules to read the description of the commands in this chapter.

Syntax

Part with heading “Syntax” describes the syntax to send a command from the external controller to the E5061A/E5062A. A syntax consists of a command part and a parameter part. The separator between the command part and the parameter part is a space.

If there are several parameters, the separator between adjacent parameters is a comma (,). 3 points (...) between commas indicate that parameters in that part are omitted. For example, <numeric 1>,...,<numeric 4> indicates that 4 parameters, <numeric 1>,<numeric 2>,<numeric 3>,<numeric 4>, are required.

String-type parameters, <string>, <string 1>, and so on, must be enclosed in double quotation marks ("). <block> shows block format data.

You can omit the lowercase letters in syntax. For example, ":CALibration:CABLe" can be shortened as ":CAL:CABL."

The definition of symbols used in the syntax is as follows:

- ◊ Characters enclosed in this pair of symbols are necessary parameters when sending the command.
- [] Part enclosed in this parenthesis pair can be omitted.
- { } Part enclosed in this parenthesis pair indicates that you must select one of the items in this part. Individual items are separated by a vertical bar (|).

For example, ":CALC:CORR:EDEL:TIME 0.1,"
":CALCULATE1:SELECTED:CORR:EDEL:TIME 25E-3," and so on are valid for the syntax given below.

Syntax :CALCulate {[1]2|3|4|5|6|7|8|9}{[:SElected]:CORRection:EDELay:TIME <numeric>

Description

Part with heading “Description” describes how to use the command or the operation when executed.

Parameters

Part with heading “Parameters” describes necessary parameters when sending the command. When a parameter is a value type or a string type enclosed with $\langle \rangle$, its description, allowable setup range, preset (factory-set) value, and so on are given; when a parameter is a selection type enclosed with $\{ \}$, the description of each selection item is given.

Query response

Part with heading “Query response” describes the data format read out when query (reading out data) is available with the command.

Each readout parameter is enclosed with $\{ \}$. If there are several items within $\{ \}$ separated by the pipe ($|$), only one of them is read out.

When several parameters are read out, they are separated with a comma ($,$). Note that, 3 points (...) between commas indicate that the data of that part is omitted. For example, $\{ \text{numeric 1} \}, \dots, \{ \text{numeric 4} \}$ indicates that 4 data items, $\{ \text{numeric 1} \}$, $\{ \text{numeric 2} \}$, $\{ \text{numeric 3} \}$, and $\{ \text{numeric 4} \}$, are read out.

$\langle \text{newline} \rangle \langle \text{^END} \rangle$ after the parameters is the program message terminator.

Related commands

Part with heading “Related commands” describes the commands related to this command.

Equivalent key

Part with heading “Equivalent key” shows the operational procedure of the front panel keys that has the same effect as this command.

- | | |
|---------------------|--|
| [Key] | Indicates that you press the key named Key. |
| [Key] - Item | Indicates a series of key operation in which you press the [Key] key, select (highlight) the item called Item on the displayed menu using the [↓] key and so on, and then press the [Enter] key. |

IEEE Common Commands

This section describes the IEEE common commands.

*CLS

Syntax	*CLS
Description	<p>Clears the followings. (No query)</p> <ul style="list-style-type: none">• Error Queue• Status Byte Register• Standard Event Status Register• Operation Status Event Register• Questionable Status Event Register• Questionable Limit Status Event Register• Questionable Limit Channel{1-4} Status Event Register
Example of use	<pre>10 OUTPUT 717; "*CLS"</pre>
Equivalent key	No equivalent key is available on the front panel.

*ESE

Syntax	*ESE <numeric> *ESE?
Description	Sets the value of the Standard Event Status Enable Register.
Parameters	

	<numeric>
Description	Setup value of the register
Range	0 to 255
Preset value	0
Resolution	1

If the specified parameter is out of the allowable setup range, the result of bitwise AND with 255 (0xff) is set.

Query response	{numeric}<newline><^END>
Example of use	10 OUTPUT 717;"*ESE 16" 20 OUTPUT 717;"*ESE?" 30 ENTER 717;A
Related commands	*SRE on page 198
Equivalent key	No equivalent key is available on the front panel.

*ESR?

Syntax	*ESR?
Description	Reads out the value of the Standard Event Status Register. Executing this command clears the register value. (Query only)
Query response	{numeric}<newline><^END>
Example of use	10 OUTPUT 717;"*ESR?" 20 ENTER 717;A
Equivalent key	No equivalent key is available on the front panel.

*IDN?

Syntax	*IDN?
Description	Reads out the product information (manufacturer, model number, serial number, and firmware version number) of the E5061A/E5062A. (Query only)
Query response	{string 1},{string 2},{string 3},{string 4}<newline><^END> Readout data is as follows: {string 1} Manufacturer. Agilent Technologies is always read out. {string 2} Model number (example: E5061A). {string 3} Serial number (example: JP1KI00101). {string 4} Firmware version number (example: 03.00).
Example of use	10 OUTPUT 717; "*IDN?" 20 ENTER 717;A\$
Equivalent key	[System] - Firmware Revision [System] - Service Menu - Enable Options - Serial Number

*OPC

Syntax	*OPC
Description	Sets the OPC bit (bit 0) of the Standard Event Status Register at the completion of all pending operations. (No query)
Example of use	10 OUTPUT 717; "*OPC"
Equivalent key	No equivalent key is available on the front panel.

*OPC?

Syntax	*OPC?
Description	1 is read out at the completion of all pending operations. (Query only)
Query response	{1}<newline><^END>
Example of use	10 OUTPUT 717; "*OPC?" 20 ENTER 717;A
Equivalent key	No equivalent key is available on the front panel.

*OPT?

Syntax	*OPT?
Description	Reads out the identification number of an option installed in the E5061A/E5062A. (Query only)
Query response	{numeric}<newline><^END> If there is no installed option, 0 is read out.
Example of use	10 OUTPUT 717;"*OPT?" 20 ENTER 717;A\$
Equivalent key	No equivalent key is available on the front panel.

*RST

Syntax	*RST
Description	Performs preset. There is the following difference from the setting state preset with the :SYST:PRES command. (No query) <ul style="list-style-type: none"> The continuous initiation mode of channel 1 is set to OFF.
Example of use	10 OUTPUT 717;"*RST"
Related commands	:SYST:PRES on page 477 :INIT{1-4}:CONT on page 339
Equivalent key	No equivalent key is available on the front panel.

*SRE

Syntax *SRE <numeric>

*SRE?

Description Sets the value of the Service Request Enable Register.

Parameters

	<numeric>
Description	Setup value of the register
Range	0 to 255
Preset value	0
Resolution	1

If the specified parameter is out of the allowable setup range, the result of bitwise AND with 255 (0xff) is set. Note that bit 6 cannot be set to 1.

Query response {numeric}<newline><^END>

Example of use
 10 OUTPUT 717; "*SRE 128"
 20 OUTPUT 717; "*SRE?"
 30 ENTER 717;A

Related commands *ESE on page 195
 :STAT:OPER:ENAB on page 440
 :STAT:QUES:ENAB on page 452

Equivalent key No equivalent key is available on the front panel.

***STB?**

Syntax	*STB?
Description	Reads out the value of the Status Byte Register. (Query only)
Query response	{numeric}<newline><^END>
Example of use	10 OUTPUT 717;"*STB?" 20 ENTER 717;A
Equivalent key	No equivalent key is available on the front panel.

***TRG**

Syntax	*TRG
Description	If the trigger source is set to GPIB/LAN (set to BUS with the :TRIG:SOUR command), triggers the E5061A/E5062A waiting for a trigger. (No query)
Example of use	10 OUTPUT 717;"*TRG"
Related commands	:TRIG:SOUR on page 483
Equivalent key	No equivalent key is available on the front panel.

***WAI**

Syntax	*WAI
Description	Waits for the execution of all commands sent before this command to be completed. (No query)
Example of use	10 OUTPUT 717;"*WAI"
Equivalent key	No equivalent key is available on the front panel.

E5061A/E5062A commands

This section describes the commands specific to the E5061A/E5062A.

:ABOR

Syntax	:ABORt
Description	<p>Aborts the measurement and changes the trigger sequence for all channels to idle state. (No query)</p> <p>After the change to the idle state, the channels for which the continuous initiation mode is set to ON (set to ON with the :INIT{1-4}:CONT command) change into the initiate state.</p> <p>For details about the trigger system, refer to “Trigger system” on page 78. (No query)</p>
Example of use	10 OUTPUT 717; ":ABOR"
Related commands	:INIT{1-4} on page 338 :INIT{1-4}:CONT on page 339
Equivalent key	[Trigger] - Restart

:CALC{1-4}:BLIM

Syntax :CALCulate{[1]2|3|4}[:SELEcted]:BLIMit[:STATe] {ON|OFF|1|0}
:CALCulate{[1]2|3|4}[:SELEcted]:BLIMit[:STATe]?

Description For the active trace of channel 1 (:CALC1) to channel 4 (:CALC4) (specified with the :CALC{1-4}:PAR{1-4}:SEL command), turns ON/OFF the bandwidth test function.

Parameters

	Description
ON or 1	Turns ON the bandwidth test function.
OFF or 0 (preset value)	Turns OFF the bandwidth test function.

Query response {1|0}<newline><<^END>

Example of use
10 OUTPUT 717;":CALC1:BLIM ON"
20 OUTPUT 717;":CALC1:BLIM?"
30 ENTER 717;A

Related commands :CALC{1-4}:PAR{1-4}:SEL on page 284
:CALC{1-4}:BLIM:DB on page 202
:CALC{1-4}:BLIM:DISP:MARK on page 203
:CALC{1-4}:BLIM:DISP:VAL on page 204
:CALC{1-4}:BLIM:FAIL? on page 205
:CALC{1-4}:BLIM:MAX on page 206
:CALC{1-4}:BLIM:MIN on page 207
:CALC{1-4}:BLIM:REP? on page 208

Equivalent key **[Analysis] - Bandwidth Limit - BW Test**

:CALC{1-4}:BLIM:DB

Syntax :CALCulate{[1][2][3][4]}[:SElected]:BLIMit:DB <numeric>
:CALCulate{[1][2][3][4]}[:SElected]:BLIMit:DB?

Description For channel 1 (:CALC1) to channel 4 (:CALC4) (specified with the :CALC{1-4}:PAR{1-4}:SEL command), sets the bandwidth threshold value (attenuation from the peak) of the bandwidth test.

Parameters

	<numeric>
Description	Bandwidth N dB points
Range	0 to 5E8
Preset value	3
Unit	dB

Query response {numeric}<newline><^END>

Example of use
10 OUTPUT 717;":CALC1:BLIM:DB 3"
20 OUTPUT 717;":CALC1:BLIM:DB?"
30 ENTER 717;A

Related commands :CALC{1-4}:PAR{1-4}:SEL on page 284
:CALC{1-4}:BLIM on page 201

Equivalent key **[Analysis] - Bandwidth Limit - N dB Points**

:CALC{1-4}:BLIM:DISP:MARK

Syntax :CALCulate{[1]2|3|4}[:SELEcted]:BLIMit:DISPlay:MARKer {ON|OFF|1|0}
:CALCulate{[1]2|3|4}[:SELEcted]:BLIMit:DISPlay:MARKer?

Description For the active trace of channel 1 (:CALC1) to channel 4 (:CALC4) (specified with the :CALC{1-4}:PAR{1-4}:SEL command), turns ON/OFF the marker display of the bandwidth test.

Parameters

	Description
ON or 1	Turns ON the bandwidth marker.
OFF or 0 (preset value)	Turns OFF the bandwidth marker.

Query response {1|0}<newline><^END>

Example of use
10 OUTPUT 717;":CALC1:BLIM:DISP:MARK ON"
20 OUTPUT 717;":CALC1:BLIM:DISP:MARK?"
30 ENTER 717;A

Related commands :CALC{1-4}:PAR{1-4}:SEL on page 284
:CALC{1-4}:BLIM on page 201
:CALC{1-4}:BLIM:DISP:VAL on page 204

Equivalent key **[Analysis] - Bandwidth Limit - BW Marker**

:CALC{1-4}:BLIM:DISP:VAL

Syntax :CALCulate{[1][2][3][4]}[:SElected]:BLIMit:DISPlay:VALue {ON|OFF|1|0}
:CALCulate{[1][2][3][4]}[:SElected]:BLIMit:DISPlay:VALue?

Description For the active trace of channel 1 (:CALC1) to channel 4 (:CALC4) (specified with the :CALC{1-4}:PAR{1-4}:SEL command), turns ON/OFF the bandwidth value display of the bandwidth test.

Parameters

	Description
ON or 1	Turns ON the bandwidth display.
OFF or 0 (preset value)	Turns OFF the bandwidth display.

Query response {1|0}<newline><^END>

Example of use
10 OUTPUT 717; ":CALC1:BLIM:DISP:VAL ON"
20 OUTPUT 717; ":CALC1:BLIM:DISP:VAL?"
30 ENTER 717;A

Related commands :CALC{1-4}:PAR{1-4}:SEL on page 284
:CALC{1-4}:BLIM on page 201
:CALC{1-4}:BLIM:DISP:MARK on page 203

Equivalent key **[Analysis] - Bandwidth Limit - BW Display**

:CALC{1-4}:BLIM:FAIL?

Syntax :CALCulate{[1]|2|3|4}[:SElected]:BLIMit:FAIL?

Description For the active trace of channel 1 (:CALC1) to channel 4 (:CALC4) (specified with the :CALC{1-4}:PAR{1-4}:SEL command), reads out the bandwidth test result. (Query only)

Query response {1|0}<newline><^END>

	Description
1	The bandwidth test result is FAIL.
0	The bandwidth test result is PASS.

When the bandwidth limit test is set to OFF, 0 is always read out.

Example of use

```
10 OUTPUT 717;":CALC1:BLIM:FAIL?"
20 ENTER 717;A
```

Related commands :CALC{1-4}:PAR{1-4}:SEL on page 284
:CALC{1-4}:BLIM on page 201

Equivalent key No equivalent key is available on the front panel.

:CALC{1-4}:BLIM:MAX

Syntax :CALCulate{[1][2][3][4]}[:SElected]:BLIMit:MAXimum <numeric>
 :CALCulate{[1][2][3][4]}[:SElected]:BLIMit:MAXimum?

Description For channel 1 (:CALC1) to channel 4 (:CALC4) (specified with the :CALC{1-4}:PAR{1-4}:SEL command), sets the upper limit value of the bandwidth test.

Parameters

	<numeric>
Description	Maximum bandwidth.
Range	0 to 1E12
Preset value	10 k
Unit	Hz (hertz), dB or second

Query response {numeric}<newline><^END>

Example of use
 10 OUTPUT 717;":CALC1:BLIM:MAX 3E5"
 20 OUTPUT 717;":CALC1:BLIM:MAX?"
 30 ENTER 717;A

Related commands :CALC{1-4}:PAR{1-4}:SEL on page 284
 :CALC{1-4}:BLIM on page 201
 :CALC{1-4}:BLIM:MIN on page 207

Equivalent key **[Analysis] - Bandwidth Limit - Max Bandwidth**

:CALC{1-4}:BLIM:MIN

Syntax :CALCulate{[1]2|3|4}[:SELEcted]:BLIMit:MINimum <numeric>
:CALCulate{[1]2|3|4}[:SELEcted]:BLIMit:MINimum?

Description For channel 1 (:CALC1) to channel 4 (:CALC4) (specified with the :CALC{1-4}:PAR{1-4}:SEL command), sets the lower limit value of the bandwidth test.

Parameters

	<numeric>
Description	Minimum bandwidth.
Range	0 to 1E12
Preset value	300 k
Unit	Hz (hertz), dB or second

Query response {numeric}<newline><^END>

Example of use
10 OUTPUT 717;":CALC1:BLIM:MIN 1E4"
20 OUTPUT 717;":CALC1:BLIM:MIN?"
30 ENTER 717;A

Related commands :CALC{1-4}:PAR{1-4}:SEL on page 284
:CALC{1-4}:BLIM on page 201
:CALC{1-4}:BLIM:MAX on page 206

Equivalent key **[Analysis] - Bandwidth Limit - Min Bandwidth**

:CALC{1-4}:BLIM:REP?

Syntax	:CALCulate{[1][2][3][4]}[:SElected]:BLIMit:REPort[:DATA]?
Description	<p>For the active trace of channel 1 (:CALC1) to channel 4 (:CALC4) (specified with the :CALC{1-4}:PAR{1-4}:SEL command), reads out the bandwidth value of the bandwidth test.</p> <p>The data transfer format when this command is executed depends on the setting with the :FORM:DATA command. (Query only)</p>
Query response	{numeric}<newline><^END>
Example of use	<pre>10 OUTPUT 717; ":CALC1:BLIM:REP?" 20 ENTER 717;A</pre>
Related commands	<p>:CALC{1-4}:PAR{1-4}:SEL on page 284</p> <p>:FORM:DATA on page 336</p> <p>:CALC{1-4}:BLIM on page 201</p>
Equivalent key	No equivalent key is available on the front panel.

:CALC{1-4}:CONV

Syntax :CALCulate{[1]|2|3|4}{:SELEcted}:CONVersion[:STATe] {ON|OFF|1|0}
:CALCulate{[1]|2|3|4}{:SELEcted}:CONVersion[:STATe]?

Description For the active trace of channel 1 (:CALC1) to channel 4 (:CALC4) (specified with the :CALC{1-4}:PAR{1-4}:SEL command), turns ON/OFF the parameter conversion function.

Parameters

	Description
ON or 1	Turns ON the parameter conversion function.
OFF or 0 (preset value)	Turns OFF the parameter conversion function.

Query response {1|0}<newline><^END>

Example of use
10 OUTPUT 717;":CALC1:CONV ON"
20 OUTPUT 717;":CALC1:CONV?"
30 ENTER 717;A

Related commands :CALC{1-4}:CONV:FUNC on page 210
:CALC{1-4}:PAR{1-4}:SEL on page 284

Equivalent key **[Analysis] - Conversion - Conversion**

:CALC{1-4}:CONV:FUNC

Syntax :CALCulate {[1]2|3|4}[:SElected]:CONVersion:FUNcTion {ZREFlection|ZTRansmit|YREFlection|YTRansmit|INVersion}
:CALCulate {[1]2|3|4}[:SElected]:CONVersion:FUNcTion?

Description For the active trace of channel 1 (:CALC1) to channel 4 (:CALC4) (specified with the :CALC{1-4}:PAR{1-4}:SEL command), select the parameter after conversion using the parameter conversion function.

Parameters

	Description
ZREFlection (preset value)	Specifies the equivalent impedance in reflection measurement.
ZTRansmit	Specifies the equivalent impedance in transmission measurement.
YREFlection	Specifies the equivalent admittance in reflection measurement.
YTRansmit	Specifies the equivalent admittance in transmission measurement.
INVersion	Specifies the inverse S-parameter.

Query response {ZREF|ZTR|YREF|YTR|INV}<newline><^END>

Example of use 10 OUTPUT 717;":CALC1:CONV:FUNC ZTR"
20 OUTPUT 717;":CALC1:CONV:FUNC?"
30 ENTER 717;A\$

Related commands :CALC{1-4}:CONV on page 209
:CALC{1-4}:PAR{1-4}:SEL on page 284

Equivalent key **[Analysis] - Conversion - Z:Reflection|Z:Transmission|Y:Reflection|Y:Transmission|1/S**

:CALC{1-4}:CORR:EDEL:TIME

Syntax :CALCulate{[1]2|3|4}[[:SELEcted]:CORRection:EDELay:TIME <numeric>
:CALCulate{[1]2|3|4}[[:SELEcted]:CORRection:EDELay:TIME?

Description Sets the electrical delay time of the active trace of channel 1 (:CALC1) to channel 4 (:CALC4) (specified with the :CALC{1-4}:PAR{1-4}:SEL command).

Parameters

	<numeric>
Description	Electrical delay time
Range	-10 to 10
Preset value	0
Unit	s (second)

If the specified parameter is out of the allowable setup range, the minimum value (if the lower limit of the range is not reached) or the maximum value (if the upper limit of the range is exceeded) is set.

Query response {numeric}<newline><^END>

Example of use
10 OUTPUT 717;":CALC1:CORR:EDEL:TIME 0.2"
20 OUTPUT 717;":CALC1:CORR:EDEL:TIME?"
30 ENTER 717;A

Related commands :CALC{1-4}:PAR{1-4}:SEL on page 284

Equivalent key **[Scale] - Electrical Delay**

:CALC{1-4}:CORR:OFFS:PHAS

Syntax :CALCulate {[1]|2|3|4}[:SElected]:CORRection:OFFSet:PHASe <numeric>
:CALCulate {[1]|2|3|4}[:SElected]:CORRection:OFFSet:PHASe?

Description Sets the phase offset of the active trace of channel 1 (:CALC1) to channel 4 (:CALC4) (specified with the :CALC{1-4}:PAR{1-4}:SEL command).

Parameters

	<numeric>
Description	Phase offset
Range	-360 to 360
Preset value	0
Unit	° (degree)

If the specified parameter is out of the allowable setup range, the minimum value (if the lower limit of the range is not reached) or the maximum value (if the upper limit of the range is exceeded) is set.

Query response {numeric}<newline><^END>

Example of use
10 OUTPUT 717; ":CALC1:CORR:OFFS:PHAS 2.5"
20 OUTPUT 717; ":CALC1:CORR:OFFS:PHAS?"
30 ENTER 717;A

Related commands :CALC{1-4}:PAR{1-4}:SEL on page 284

Equivalent key [Scale] - Phase Offset

:CALC{1-4}:DATA:FDAT

Syntax :CALCulate{[1]2[3]4}[:SElected]:DATA:FDATa <numeric1>,...,<numeric NOP×2>
:CALCulate{[1]2[3]4}[:SElected]:DATA:FDATa?

Description For the active trace of channel 1 (:CALC1) to channel 4 (:CALC4) (specified with the :CALC{1-4}:PAR{1-4}:SEL command), sets/reads out the formatted data array. (It is the data array for which processing such as format has been performed for corrected data array. For details, refer to “Formatted data array” on page 107.)

The data transfer format when this command is executed depends on the setting with the :FORM:DATA command.

Parameters

	Description
<numeric n×2-1>	Data (primary value) at the n-th measurement point.
<numeric n×2>	Data (secondary value) at the n-th measurement point. Always 0 when the data format is not the Smith chart format or the polar format.

Where NOP is the number of measurement points and n is an integer between 1 and NOP.

Query response {numeric 1},...,{numeric NOP×2}<newline><^END>

Example of use

```
10 DIM A(1:201,1:2)
20 OUTPUT 717;":CALC1:DATA:FDAT?"
30 ENTER 717;A(*)
```

Related commands :CALC{1-4}:PAR{1-4}:SEL on page 284
:CALC{1-4}:DATA:FMEM on page 214
:CALC{1-4}:DATA:SDAT on page 215
:FORM:DATA on page 336

Equivalent key No equivalent key is available on the front panel.

:CALC{1-4}:DATA:FMEM

Syntax :CALCulate {[1]|2|3|4}[:SElected]:DATA:FMEMory <numeric 1>,...,<numeric NOP×2>
:CALCulate {[1]|2|3|4}[:SElected]:DATA:FMEMory?

Description For the active trace of channel 1 (:CALC1) to channel 4 (:CALC4) (specified with the :CALC{1-4}:PAR{1-4}:SEL command), sets/reads out the formatted memory array. (It is the data array for which processing such as format has been performed for corrected memory array. For details, refer to “Formatted memory arrays” on page 108.)

The data transfer format when this command is executed depends on the setting with the :FORM:DATA command.

Parameters

	Description
<numeric n×2-1>	Data (primary value) at the n-th measurement point.
<numeric n×2>	Data (secondary value) at the n-th measurement point. Always 0 when the data format is not the Smith chart format or the polar format.

Where NOP is the number of measurement points and n is an integer between 1 and NOP.

Query response {numeric 1},...,{numeric NOP×2}<newline><^END>

Example of use

```
10 DIM A(1:201,1:2)
20 OUTPUT 717;":CALC1:DATA:FMEM?"
30 ENTER 717;A(*)
```

Related commands :CALC{1-4}:PAR{1-4}:SEL on page 284
:CALC{1-4}:DATA:FDAT on page 213
:CALC{1-4}:DATA:SMEM on page 216
:FORM:DATA on page 336

Equivalent key No equivalent key is available on the front panel.

:CALC{1-4}:DATA:SDAT

Syntax :CALCulate{[1]|2|3|4}[:SElected]:DATA:SDATa <numeric 1>,...,<numeric NOP×2>
:CALCulate{[1]|2|3|4}[:SElected]:DATA:SDATa?

Description For the active trace of channel 1 (:CALC1) to channel 4 (:CALC4) (specified with the :CALC{1-4}:PAR{1-4}:SEL command), sets/reads out the corrected data array. (It is the data array for which processing such as error correction to measured raw data has been performed. For details, refer to “Corrected data arrays” on page 106.)
The data transfer format when this command is executed depends on the setting with the :FORM:DATA command.

Query response {numeric 1},...,{numeric NOP×2}<newline><^END>

	Description
{numeric n×2-1}	Real part of the data (complex number) at the n-th measurement point.
{numeric n×2}	Imaginary part of the data (complex number) at the n-th measurement point.

Where NOP is the number of measurement points and n is an integer between 1 and NOP.

Example of use

```
10 DIM A(1:201,1:2)
20 OUTPUT 717;" :CALC1:DATA:SDAT?"
30 ENTER 717;A(*)
```

Related commands :CALC{1-4}:DATA:SMEM on page 216
:CALC{1-4}:DATA:FDAT on page 213
:FORM:DATA on page 336

Equivalent key No equivalent key is available on the front panel.

:CALC{1-4}:DATA:SMEM

Syntax :CALCulate {[1]|2|3|4}[:SElected]:DATA:SMEMory <numeric 1>,...,<numeric NOP×2>
:CALCulate {[1]|2|3|4}[:SElected]:DATA:SMEMory?

Description For the active trace of channel 1 (:CALC1) to channel 4 (:CALC4) (specified with the :CALC{1-4}:PAR{1-4}:SEL command), sets/reads out the corrected memory array. (It is the copy of the corrected data array when the :CALC{1-4}:MATH:MEM command is executed. For details, refer to “Corrected memory arrays” on page 106.)

The data transfer format when this command is executed depends on the setting with the :FORM:DATA command. (Query only)

Query response {numeric 1},...,{numeric NOP×2}<newline><^END>

	Description
{numeric n×2-1}	Real part of the data (complex number) at the n-th measurement point.
{numeric n×2}	Imaginary part of the data (complex number) at the n-th measurement point.

Where NOP is the number of measurement points and n is an integer between 1 and NOP.

Example of use

```
10 DIM A(1:201,1:2)
20 OUTPUT 717;":CALC1:DATA:SMEM?"
30 ENTER 717;A(*)
```

Related commands :CALC{1-4}:MATH:MEM on page 279
:CALC{1-4}:DATA:SDAT on page 215
:CALC{1-4}:DATA:FMEM on page 214
:FORM:DATA on page 336

Equivalent key No equivalent key is available on the front panel.

:CALC{1-4}:FORM

Syntax :CALCulate{[1]|2|3|4}[:SELEcted]:FORMat {MLOGarithmic|PHASe|GDELay|SLINear|SLOGarithmic|SCOMplex|SMITH|SADMittance|PLINear|PLOGarithmic|POLar|MLINear|SWR|REAL|IMAGinary|UPHase|PPHase}
:CALCulate{[1]|2|3|4}[:SELEcted]:FORMat?

Description Selects the data format of the active trace of channel 1 (:CALC1) to channel 4 (:CALC4) (specified with the :CALC{1-4}:PAR{1-4}:SEL command).

Parameters

	Description
MLOGarithmic (preset value)	Specifies the logarithmic magnitude format.
PHASe	Specifies the phase format.
GDELay	Specifies the group delay format.
SLINear	Specifies the Smith chart format (Lin/Phase).
SLOGarithmic	Specifies the Smith chart format (Log/Phase).
SCOMplex	Specifies the Smith chart format (Real/Imag).
SMITH	Specifies the Smith chart format (R+jX).
SADMittance	Specifies the Smith chart format (G+jB).
PLINear	Specifies the polar format (Lin).
PLOGarithmic	Specifies the polar format (Log).
POLar	Specifies the polar format (Re/Im).
MLINear	Specifies the linear magnitude format.
SWR	Specifies the SWR format.
REAL	Specifies the real format.
IMAGinary	Specifies the imaginary format.
UPHase	Specifies the expanded phase format.
PPHase	Specifies the positive phase format.

Query response {MLOG|PHAS|GDEL|SLIN|SLOG|SCOM|SMIT|SADM|PLIN|PLOG|POL|MLIN|SWR|REAL|IMAG|UPH|PPH}<newline><^END>

Example of use
10 OUTPUT 717;":CALC1:FORM SLIN"
20 OUTPUT 717;":CALC1:FORM?"
30 ENTER 717;A\$

Related commands :CALC{1-4}:PAR{1-4}:SEL on page 284

Equivalent key [Format] - Log Mag|Phase|Group Delay|Lin Mag|SWR|Real|Imaginary|Expand Phase|Positive Phase

SCPI Command Reference
E5061A/E5062A commands

[Format] - Smith - Lin/Phase|Log/Phase|Real/Imag|R+jX|G+jB

[Format] - Polar - Lin/Phase|Log/Phase|Real/Imag

:CALC{1-4}:FUNC:DATA?

Syntax :CALCulate{[1]|2|3|4}[:SELEcted]:FUNCtion:DATA?

Description For the active trace of channel 1 (:CALC1) to channel 4 (:CALC4) (specified with the :CALC{1-4}:PAR{1-4}:SEL command), reads out the analysis result of the :CALC{1-4}:FUNC:EXEC command.

The data transfer format when this command is executed depends on the setting with the :FORM:DATA command. (Query only)

Query response {numeric 1},..., {numeric N×2}<newline><^END>

	Description
{numeric n×2-1}	Response value or analysis result of the searched n-th measurement point.
{numeric n×2}	Stimulus value of the searched n-th measurement point. Always set to 0 for the analysis of maximum and minimum values/standard deviation/mean value.

Where N is the number of data pairs (can be read out with :CALC{1-4}:FUNC:POIN? command) and n is an integer between 1 and N.

Example of use

```

10  OUTPUT 717;":CALC1:FUNC:POIN?"
20  ENTER 717;A
30  REDIM B(1:2*A)
40  OUTPUT 717;":CALC1:FUNC:DATA?"
50  ENTER 717;B(*)

```

Related commands :CALC{1-4}:FUNC:EXEC on page 223
:CALC{1-4}:FUNC:POIN? on page 225
:CALC{1-4}:PAR{1-4}:SEL on page 284
:FORM:DATA on page 336

Equivalent key No equivalent key is available on the front panel.

:CALC{1-4}:FUNC:DOM

Syntax :CALCulate {[1]2|3|4}[:SElected]:FUNction:DOMain[:STATe] {ON|OFF|1|0}
:CALCulate {[1]2|3|4}[:SElected]:FUNction:DOMain[:STATe]?

Description For channel 1 (:CALC1) to channel 4 (:CALC4), sets whether to use an arbitrary range when executing the analysis with the :CALC{1-4}:FUNC:EXEC command.

When the trace coupling is off, the active trace is the target to be set.

Parameters

	Description
ON or 1	Specifies an arbitrary range ^{*1} .
OFF or 0 (preset value)	Specifies the entire sweep range.

*1. Use the :CALC{1-4}:FUNC:DOM:STAR command and the :CALC{1-4}:FUNC:DOM:STOP command to specify a range.

Query response {1|0}<newline><^END>

Example of use

```
10 OUTPUT 717; ":CALC1:FUNC:DOM ON"
20 OUTPUT 717; ":CALC1:FUNC:DOM?"
30 ENTER 717;A
```

Related commands :CALC{1-4}:FUNC:EXEC on page 223
:CALC{1-4}:FUNC:DOM:COUP on page 221
:CALC{1-4}:FUNC:DOM:STAR on page 222
:CALC{1-4}:FUNC:DOM:STOP on page 223

Equivalent key No equivalent key is available on the front panel.

:CALC{1-4}:FUNC:DOM:COUP

Syntax :CALCulate{[1]|2|3|4}[:SELEcted]:FUNCTion:DOMain:COUPle {ON|OFF|1|0}
:CALCulate{[1]|2|3|4}[:SELEcted]:FUNCTion:DOMain:COUPle?

Description For channel 1 (:CALC1) to channel 4 (:CALC4), specifies whether to set the coupling of the analysis range of the :CALC{1-4}:FUNC:EXEC command for all traces.

Parameters

	Description
ON or 1 (preset value)	Specifies the analysis range with the trace coupling.
OFF or 0	Specifies the analysis range for each trace.

Query response {1|0}<newline><^END>

Example of use
10 OUTPUT 717;":CALC1:FUNC:DOM:COUP OFF"
20 OUTPUT 717;":CALC1:FUNC:DOM:COUP?"
30 ENTER 717;A

Related commands :CALC{1-4}:FUNC:EXEC on page 223

Equivalent key No equivalent key is available on the front panel.

:CALC{1-4}:FUNC:DOM:STAR

Syntax :CALCulate {[1]2|3|4}[:SElected]:FUNction:DOMain:STARt <numeric>
:CALCulate {[1]2|3|4}[:SElected]:FUNction:DOMain:STARt?

Description For channel 1 (:CALC1) to channel 4 (:CALC4), sets the start value of the analysis range of the :CALC{1-4}:FUNC:EXEC command.

When the trace coupling is off, the active trace is the target to be set.

Parameters

	<numeric>
Description	Start value of the analysis range
Preset value	0
Unit	Hz (hertz), dBm or second

Query response {numeric}<newline><^END>

Example of use
10 OUTPUT 717; ":CALC1:FUNC:DOM:STAR 1.7E9"
20 OUTPUT 717; ":CALC1:FUNC:DOM:STAR?"
30 ENTER 717;A

Related commands :CALC{1-4}:FUNC:EXEC on page 223
:CALC{1-4}:FUNC:DOM on page 220
:CALC{1-4}:FUNC:DOM:COUP on page 221
:CALC{1-4}:FUNC:DOM:STOP on page 223

Equivalent key No equivalent key is available on the front panel.

:CALC{1-4}:FUNC:DOM:STOP

Syntax :CALCulate{[1]|2|3|4}[:SElected]:FUNCtion:DOMain:STOP <numeric>
:CALCulate{[1]|2|3|4}[:SElected]:FUNCtion:DOMain:STOP?

Description For channel 1 (:CALC1) to channel 4 (:CALC4), sets the stop value of the analysis range of the :CALC{1-4}:FUNC:EXEC command.
When the trace coupling is off, the active trace is the target to be set.

Parameters

	<numeric>
Description	Stop value of the analysis range
Preset value	0
Unit	Hz (hertz), dBm or second

Query response {numeric}<newline><^END>

Example of use
10 OUTPUT 717;":CALC1:FUNC:DOM:STOP 1.8E9"
20 OUTPUT 717;":CALC1:FUNC:DOM:STOP?"
30 ENTER 717;A

Related commands :CALC{1-4}:FUNC:EXEC on page 223
:CALC{1-4}:FUNC:DOM on page 220
:CALC{1-4}:FUNC:DOM:COUP on page 221
:CALC{1-4}:FUNC:DOM:STAR on page 222

Equivalent key No equivalent key is available on the front panel.

:CALC{1-4}:FUNC:EXEC

Syntax :CALCulate{[1]|2|3|4}[:SElected]:FUNCtion:EXECute

Description For the active trace of channel 1 (:CALC1) to channel 4 (:CALC4) (specified with the :CALC{1-4}:PAR{1-4}:SEL command), executes the analysis specified with the :CALC{1-4}:FUNC:TYPE command. (No query)

Example of use 10 OUTPUT 717;":CALC1:FUNC:EXEC"

Related commands :CALC{1-4}:FUNC:TYPE on page 229
:CALC{1-4}:FUNC:DOM on page 220
:CALC{1-4}:PAR{1-4}:SEL on page 284

Equivalent key No equivalent key is available on the front panel.

:CALC{1-4}:FUNC:PEXC

Syntax :CALCulate {[1]2|3|4}[:SELEcted]:FUNction:PEXCursion <numeric>
:CALCulate {[1]2|3|4}[:SELEcted]:FUNction:PEXCursion?

Description For the active trace of channel 1 (:CALC1) to channel 4 (:CALC4) (specified with the :CALC{1-4}:PAR{1-4}:SEL command), sets the lower limit for the peak excursion value when executing the peak search with the :CALC{1-4}:FUNC:EXEC command.

Parameters

	<numeric>
Description	Lower limit for the peak excursion value
Range	0 to 5e8
Preset value	3
Unit	Varies depending on the data format as follows: Logarithmic Magnitude: dB (decibel) Phase, Expand Phase, Positive Phase: ° (degree) Group Delay: s (second) Others: No unit

If the specified parameter is out of the allowable setup range, the minimum value (if the lower limit of the range is not reached) or the maximum value (if the upper limit of the range is exceeded) is set.

Query response {numeric}<newline><^END>

Example of use
10 OUTPUT 717; ":CALC1:FUNC:PEXC 0.2"
20 OUTPUT 717; ":CALC1:FUNC:PEXC?"
30 ENTER 717;A

Related commands :CALC{1-4}:FUNC:EXEC on page 223
:CALC{1-4}:FUNC:PPOL on page 226
:CALC{1-4}:FUNC:TYPE on page 229
:CALC{1-4}:PAR{1-4}:SEL on page 284

Equivalent key No equivalent key is available on the front panel.

:CALC{1-4}:FUNC:POIN?

Syntax	:CALCulate{[1] 2 3 4}[[:SElected]:FUNCtion:POINts?
Description	<p>For the active trace of channel 1 (:CALC1) to channel 4 (:CALC4) (specified with the :CALC{1-4}:PAR{1-4}:SEL command), reads out the number of data pairs of the analysis result of the :CALC{1-4}:FUNC:EXEC command.</p> <p>For the analysis of the mean value or the search of the maximum value, 1 is always read out; for the search of all peaks or the search of all targets, the total number of searched measurement points is read out. (Query only)</p>
Query response	{numeric}<newline><^END>
Example of use	<pre>10 OUTPUT 717;":CALC1:FUNC:POIN?" 20 ENTER 717;A</pre>
Related commands	<p>:CALC{1-4}:FUNC:EXEC on page 223</p> <p>:CALC{1-4}:FUNC:DATA? on page 219</p> <p>:CALC{1-4}:PAR{1-4}:SEL on page 284</p>
Equivalent key	No equivalent key is available on the front panel.

:CALC{1-4}:FUNC:PPOL

Syntax :CALCulate{[1]|2|3|4}[[:SElected]:FUNction:PPOLarity {POSitive|NEGative|BOTH}]
:CALCulate{[1]|2|3|4}[[:SElected]:FUNction:PPOLarity?

Description For the active trace of channel 1 (:CALC1) to channel 4 (:CALC4) (specified with the :CALC{1-4}:PAR{1-4}:SEL command), selects the polarity when performing the peak search with the :CALC{1-4}:FUNC:EXEC command.

Parameters

	Description
POSitive (preset value)	Specifies the positive peak.
NEGative	Specifies the negative peak.
BOTH	Specifies both the positive peak and the negative peak.

Query response {POS|NEG|BOTH}<newline><^END>

Example of use
10 OUTPUT 717;":CALC1:FUNC:PPOL BOTH"
20 OUTPUT 717;":CALC1:FUNC:PPOL?"
30 ENTER 717;A\$

Related commands :CALC{1-4}:FUNC:EXEC on page 223
:CALC{1-4}:FUNC:PEXC on page 224
:CALC{1-4}:FUNC:TYPE on page 229
:CALC{1-4}:PAR{1-4}:SEL on page 284

Equivalent key No equivalent key is available on the front panel.

:CALC{1-4}:FUNC:TARG

Syntax :CALCulate{[1]|2|3|4}[:SELEcted]:FUNCTion:TARGet <numeric>
:CALCulate{[1]|2|3|4}[:SELEcted]:FUNCTion:TARGet?

Description For the active trace of channel 1 (:CALC1) to channel 4 (:CALC4) (specified with the :CALC{1-4}:PAR{1-4}:SEL command), selects the target value when performing the target search with the :CALC{1-4}:FUNC:EXEC command.

Parameters

	<numeric>
Description	Target value
Range	-5E8 to 5E8
Preset value	0
Unit	Varies depending on the data format as follows: Logarithmic Magnitude: dB (decibel) Phase, Expand Phase, Positive Phase: ° (degree) Group Delay: s (second) Others: No unit

If the specified parameter is out of the allowable setup range, the minimum value (if the lower limit of the range is not reached) or the maximum value (if the upper limit of the range is exceeded) is set.

Query response {numeric}<newline><^END>

Example of use
10 OUTPUT 717;":CALC1:FUNC:TARG -12.5"
20 OUTPUT 717;":CALC1:FUNC:TARG?"
30 ENTER 717;A

Related commands :CALC{1-4}:FUNC:EXEC on page 223
:CALC{1-4}:FUNC:TTR on page 228
:CALC{1-4}:FUNC:TYPE on page 229
:CALC{1-4}:PAR{1-4}:SEL on page 284

Equivalent key No equivalent key is available on the front panel.

:CALC{1-4}:FUNC:TTR

Syntax :CALCulate {[1]2|3|4}[:SElected]:FUNCtion:TTRansition {POSitive|NEGative|BOTH}

:CALCulate {[1]2|3|4}[:SElected]:FUNCtion:TTRansition?

Description For the active trace of channel 1 (:CALC1) to channel 4 (:CALC4) (specified with the :CALC{1-4}:PAR{1-4}:SEL command), selects the transition type when performing the target search with the :CALC{1-4}:FUNC:EXEC command.

Parameters

	Description
POSitive	Specifies positive.
NEGative	Specifies negative.
BOTH (preset value)	Specifies both positive and negative.

Query response {POS|NEG|BOTH}<newline><^END>

Example of use

```

10 OUTPUT 717; ":CALC1:FUNC:TTR NEG"
20 OUTPUT 717; ":CALC1:FUNC:TTR?"
30 ENTER 717;A$

```

Related commands :CALC{1-4}:FUNC:EXEC on page 223
:CALC{1-4}:FUNC:TARG on page 227
:CALC{1-4}:FUNC:TYPE on page 229
:CALC{1-4}:PAR{1-4}:SEL on page 284

Equivalent key No equivalent key is available on the front panel.

:CALC{1-4}:FUNC:TYPE

Syntax :CALCulate{[1]|2|3|4}{[:SElected]:FUNCtion:TYPE {PTPeak| STDEV|MEAN| MAXimum|MINimum|PEAK|APEak|ATARget}
:CALCulate{[1]|2|3|4}{[:SElected]:FUNCtion:TYPE?

Description For the active trace of channel 1 (:CALC1) to channel 4 (:CALC4) (specified with the :CALC{1-4}:PAR{1-4}:SEL command), selects the type of analysis.

Parameters

	Description
PTPeak (preset value)	Specifies the analysis of the difference between the maximum value and the minimum value (Peak to Peak).
STDEV	Specifies the analysis of the standard deviation.
MEAN	Specifies the analysis of the mean value.
MAXimum	Specifies the search for the maximum value.
MINimum	Specifies the search for the minimum value.
PEAK	Specifies the search for the maximum positive (minimum negative) peak ^{*1} .
APEak	Specifies the search for all peaks ^{*1} .
ATARget	Specifies the search for all targets ^{*2} .

*1. To specify the conditions of the peak, use the :CALC{1-4}:FUNC:PEXC command and the :CALC{1-4}:FUNC:PPOL command.

*2. To specify the conditions of the target, use the :CALC{1-4}:FUNC:TARG command and the :CALC{1-4}:FUNC:TTR command.

Query response {PTP|STDEV|MEAN|MAX|MIN|PEAK|APE|ATAR}<newline><^END>

Example of use
10 OUTPUT 717;":CALC1:FUNC:TYPE PEAK"
20 OUTPUT 717;":CALC1:FUNC:TYPE?"
30 ENTER 717;A\$

Related commands :CALC{1-4}:FUNC:EXEC on page 223
:CALC{1-4}:FUNC:PEXC on page 224
:CALC{1-4}:FUNC:PPOL on page 226
:CALC{1-4}:FUNC:TARG on page 227
:CALC{1-4}:FUNC:TTR on page 228
:CALC{1-4}:PAR{1-4}:SEL on page 284

Equivalent key No equivalent key is available on the front panel.

:CALC{1-4}:LIM

Syntax :CALCulate {[1]|2|3|4}[:SElected]:LIMit[:STATe] {ON|OFF|1|0}
:CALCulate {[1]|2|3|4}[:SElected]:LIMit[:STATe]?

Description For the active trace of channel 1 (:CALC1) to channel 4 (:CALC4) (specified with the :CALC{1-4}:PAR{1-4}:SEL command), turns ON/OFF the limit test function.

Parameters

	Description
ON or 1	Turns ON the limit test.
OFF or 0 (preset value)	Turns OFF the limit test.

Query response {1|0}<newline><^END>

Example of use
10 OUTPUT 717; ":CALC1:LIM ON"
20 OUTPUT 717; ":CALC1:LIM?"
30 ENTER 717;A

Related commands :CALC{1-4}:PAR{1-4}:SEL on page 284
:CALC{1-4}:LIM:DISP on page 233
:DISP:FSIG on page 311

Equivalent key **[Analysis] - Limit Test - Limit Test**

:CALC{1-4}:LIM:DATA

Syntax :CALCulate{[1]|2|3|4}[:SElected]:LIMit:DATA <numeric 1>,...,<numeric 1+(N×5)>
:CALCulate{[1]|2|3|4}[:SElected]:LIMit:DATA?

Description For the active trace of channel 1 (:CALC1) to channel 4 (:CALC4) (specified with the :CALC{1-4}:PAR{1-4}:SEL command), sets the limit table.
The data transfer format when this command is executed depends on the setting with the :FORM:DATA command.

Parameters

	Description
<numeric 1>	The number of lines. (0 to 100)
<numeric 1+(n×5)-4>	The type of the n-th line. Specify an integer 0 to 2: 0: Off 1: Upper limit line 2: Lower limit line
<numeric 1+(n×5)-3>	The value on the horizontal axis (frequency/power/time) of the start point of the n-th line.
<numeric 1+(n×5)-2>	The value on the horizontal axis (frequency/power/time) of the end point of the n-th line.
<numeric 1+(n×5)-1>	The value on the vertical axis of the start point of the n-th line.
<numeric 1+(n×5)>	The value on the vertical axis of the end point of the n-th line.

Where N is the number of lines (specified with <numeric 1>) and n is an integer between 1 and N.

If you set the number of lines to 0 (clear the limit table), this command needs only <numeric 1> as the parameter.

Query response {numeric 1},...,{numeric 1+(N×5)}<newline><^END>

Example of use

```

10 DIM B(1:2,1:5)
20 OUTPUT 717;":CALC1:LIM:DATA 2,1,1E9,3E9,0,0,2,1E9,3E9,-3,-3"
30 OUTPUT 717;":CALC1:LIM:DATA?"
40 ENTER 717;A,B(*)

10 OUTPUT 717;":CALC1:LIM:DATA 0" ! Clear Limit Table

```

Related commands :CALC{1-4}:PAR{1-4}:SEL on page 284
:CALC{1-4}:LIM on page 230
:CALC{1-4}:LIM:DISP on page 233
:FORM:DATA on page 336

Equivalent key **[Analysis] - Limit Test - Edit Limit Line**

:CALC{1-4}:LIM:DISP

Syntax :CALCulate{[1]|2|3|4}[:SELEcted]:LIMit:DISPlay[:STATe] {ON|OFF|1|0}
:CALCulate{[1]|2|3|4}[:SELEcted]:LIMit:DISPlay[:STATe]?

Description For the active trace of channel 1 (:CALC1) to channel 4 (:CALC4) (specified with the :CALC{1-4}:PAR{1-4}:SEL command), turns ON/OFF the limit line display.

Parameters

	Description
ON or 1	Turns ON the limit line display.
OFF or 0 (preset value)	Turns OFF the limit line display.

Query response {1|0}<newline><^END>

Example of use
10 OUTPUT 717;":CALC1:LIM:DISP ON"
20 OUTPUT 717;":CALC1:LIM:DISP?"
30 ENTER 717;A

Related commands :CALC{1-4}:LIM on page 230
:CALC{1-4}:PAR{1-4}:SEL on page 284

Equivalent key **[Analysis] - Limit Test - Limit Line**

:CALC{1-4}:LIM:DISP:CLIP

Syntax :CALCulate {[1]|2|3|4}[:SElected]:LIMit:DISPlay:CLIP {ON|OFF|1|0}
:CALCulate {[1]|2|3|4}[:SElected]:LIMit:DISPlay:CLIP?

Description For the active trace of channel 1 (:CALC1) to channel 4 (:CALC4) (specified with the :CALC{1-4}:PAR{1-4}:SEL command), specifies whether to display the part of the limit line(s) that is not used for evaluation.

Parameters

	Description
ON or 1 (preset value)	Displays the clipped limit line(s).
OFF or 0	Displays the entire limit line(s).

Query response {1|0}<newline><^END>

Example of use
10 OUTPUT 717;":CALC1:LIM:DISP:CLIP OFF"
20 OUTPUT 717;":CALC1:LIM:DISP:CLIP?"
30 ENTER 717;A

Related commands :CALC{1-4}:LIM on page 230
:CALC{1-4}:PAR{1-4}:SEL on page 284

Equivalent key **[Analysis] - Limit Test - Clip Lines**

:CALC{1-4}:LIM:FAIL?

Syntax :CALCulate{[1]|2|3|4}[[:SELEcted]:LIMit:FAIL?

Description For the active trace of channel 1 (:CALC1) to channel 4 (:CALC4) (specified with the :CALC{1-4}:PAR{1-4}:SEL command), reads out the limit test result. (Query only)

Query response {1|0}<newline><^END>

	Description
1	The limit test result is FAIL.
0	The limit test result is PASS.

When the limit test is set to OFF, 0 is always read out.

Example of use
10 OUTPUT 717;":CALC1:LIM:FAIL?"
20 ENTER 717;A

Related commands :CALC{1-4}:LIM on page 230
:CALC{1-4}:PAR{1-4}:SEL on page 284

Equivalent key No equivalent key is available on the front panel.

:CALC{1-4}:LIM:OFFS:AMPL

Syntax :CALCulate{[1]|2|3|4}[:SElected]:LIMit:OFFSet:AMPLitude <numeric>
:CALCulate{[1]|2|3|4}[:SElected]:LIMit:OFFSet:AMPLitude?

Description For channel 1 (:CALC1) to channel 4 (:CALC4) (specified with the :CALC{1-4}:PAR{1-4}:SEL command), sets the limit line amplitude offset. The setting of the limit line doesn't change even if the offset value is changed.

Parameters

	<numeric>
Description	The limit line amplitude offset value for the limit test.
Range	-5E8 to 5E8
Preset value	0
Unit	dB

Query response {numeric}<newline><^END>

Example of use

```
10 OUTPUT 717; ":CALC1:LIM:OFFS:AMPL -10"
20 OUTPUT 717; ":CALC1:LIM:OFFS:AMPL?"
30 ENTER 717;A
```

Related commands :CALC{1-4}:LIM on page 230
:CALC{1-4}:LIM:OFFS:MARK on page 237
:CALC{1-4}:LIM:OFFS:STIM on page 238

Equivalent key **[Analysis] - Limit Test - Limit Line Offsets - Amplitude Offset**

:CALC{1-4}:LIM:OFFS:MARK

Syntax	<code>:CALCulate{[1]2 3 4}{[:SELEcted]:LIMit:OFFSet:MARKer</code>
Description	<p>For channel 1 (:CALC1) to channel 4 (:CALC4) (specified with the :CALC{1-4}:PAR{1-4}:SEL command), sets the active marker value to amplitude offset using the limit line.</p> <p>The setting of the limit line does not change even if the offset value is changed.</p> <p>When the markers are not displayed, this command does not operate.</p>
Example of use	<code>10 OUTPUT 717; ":CALC1:LIM:OFFS:MARK"</code>
Related commands	<code>:CALC{1-4}:LIM</code> on page 230 <code>:CALC{1-4}:LIM:OFFS:AMPL</code> on page 236 <code>:CALC{1-4}:LIM:OFFS:STIM</code> on page 238
Equivalent key	[Analysis] - Limit Test - Limit Line Offsets - Marker -> Amplitude Offset

:CALC{1-4}:LIM:OFFS:STIM

Syntax :CALCulate{[1]|2|3|4}[:SElected]:LIMit:OFFSet:STIMulus <numeric>
 :CALCulate{[1]|2|3|4}[:SElected]:LIMit:OFFSet:STIMulus?

Description For channel 1 (:CALC1) to channel 4 (:CALC4) (specified with the :CALC{1-4}:PAR{1-4}:SEL command), sets the stimulus offset of the limit line. The setting of the limit line doesn't change even if the offset value is changed.

Parameters

	<numeric>
Description	The stimulus offset value of the limit line.
Range	-1E12 to 1E12
Preset value	0
Unit	Hz (hertz), dBm or second

Query response {numeric}<newline><^END>

Example of use
 10 OUTPUT 717;":CALC1:LIM:OFFS:STIM 5E3"
 20 OUTPUT 717;":CALC1:LIM:OFFS:STIM?"
 30 ENTER 717;A

Related commands :CALC{1-4}:LIM on page 230
 :CALC{1-4}:LIM:OFFS:AMPL on page 236
 :CALC{1-4}:LIM:OFFS:MARK on page 237

Equivalent key **[Analysis] - Limit Test - Limit Line Offsets - Stimulus Offset**

:CALC{1-4}:LIM:REP:ALL?

Syntax :CALCulate{[1]2|3|4}[:SELEcted]:LIMit:REPort:ALL?

Description For the active trace of channel 1 (:CALC1) to channel 4 (:CALC4) (specified with the :CALC{1-4}:PAR{1-4}:SEL command), reads out the bandwidth test results (stimulus value, limit test result, upper limit value, lower limit value of all measurement points).
The data transfer format when this command is executed depends on the setting with the :FORM:DATA command. (Query only)

Query Response {numeric 1},..., {numeric N×4}<newline><^END>

	Description
<numeric n×4-3>	The stimulus value for the measurement point.
<numeric n×4-2>	The limit test result. Specify an integer -1 to 1: 0: Fail 1: Pass -1: No limit
<numeric n×4-1>	The upper limit value at the measurement point. (If there is no limit at this point, reads out 0.)
<numeric n×4>	The lower limit value at the measurement point. (If there is no limit at this point, reads out 0.)

Where N is the number of measurement points (specified with the :SENS{1-4}:SWE:POIN command) and n is an integer between 1 and N.

Example of use

```

10 OUTPUT 717;":SENS1:SWE:POIN?"
20 ENTER 717;A
30 REDIM B(1:4*A)
40 OUTPUT 717;":CALC1:LIM:REP:ALL?"
50 ENTER 717;B(*)

```

Related commands :CALC{1-4}:PAR{1-4}:SEL on page 284
:CALC{1-4}:LIM on page 230
:CALC{1-4}:LIM:REP? on page 240
:CALC{1-4}:LIM:REP:POIN? on page 240

Equivalent key No equivalent key is available on the front panel.

:CALC{1-4}:LIM:REP?

Syntax	:CALCulate {[1] 2 3 4}[:SElected]:LIMit:REPort[:DATA]?
Description	<p>For the active trace of channel 1 (:CALC1) to channel 4 (:CALC4) (specified with the :CALC{1-4}:PAR{1-4}:SEL command), reads out the stimulus values (frequency, power level or time) at all the measurement point that failed the limit test.</p> <p>The data transfer format when this command is executed depends on the setting with the :FORM:DATA command.(Query only)</p>
Query response	<p>{numeric 1},...,{numeric N}<newline><^END></p> <p>Where N is the number of the measurement points that failed (can be read out with the :CALC{1-4}:LIM:REP:POIN? command).</p>
Example of use	<pre>10 OUTPUT 717;":CALC1:LIM:REP:POIN?" 20 ENTER 717;A 30 REDIM B(1:A) 40 OUTPUT 717;":CALC1:LIM:REP?" 50 ENTER 717;B(*)</pre>
Related commands	<p>:CALC{1-4}:PAR{1-4}:SEL on page 284</p> <p>:FORM:DATA on page 336</p> <p>:CALC{1-4}:LIM:REP:POIN? on page 240</p> <p>:CALC{1-4}:LIM on page 230</p>
Equivalent key	No equivalent key is available on the front panel.

:CALC{1-4}:LIM:REP:POIN?

Syntax	:CALCulate {[1] 2 3 4}[:SElected]:LIMit:REPort:POINts?
Description	For the active trace of channel 1 (:CALC1) to channel 4 (:CALC4) (specified with the :CALC{1-4}:PAR{1-4}:SEL command), reads out the number of the measurement points that failed the limit test. (Query only)
Query response	{numeric}<newline><^END>
Example of use	<pre>10 OUTPUT 717;":CALC1:LIM:REP:POIN?" 20 ENTER 717;A</pre>
Related commands	<p>:CALC{1-4}:PAR{1-4}:SEL on page 284</p> <p>:CALC{1-4}:LIM on page 230</p>
Equivalent key	No equivalent key is available on the front panel.

:CALC{1-4}:MARK:BWID

Syntax :CALCulate{[1]|2|3|4}[:SELEcted]:MARKer:BWIDth[:STATe] {ON|OFF|1|0}
:CALCulate{[1]|2|3|4}[:SELEcted]:MARKer:BWIDth[:STATe]?

Description For the active trace of channel 1 (:CALC1) to channel 4 (:CALC4) (specified with the :CALC{1-4}:PAR{1-4}:SEL command), turns ON/OFF the bandwidth search result display.

Parameters

	Description
ON or 1	Turns ON the bandwidth search result display.
OFF or 0 (preset value)	Turns OFF the bandwidth search result display.

Query response {1|0}<newline><^END>

Example of use
10 OUTPUT 717;":CALC1:MARK:BWID ON"
20 OUTPUT 717;":CALC1:MARK:BWID?"
30 ENTER 717;A

Related commands :CALC{1-4}:MARK{1-10}:BWID:DATA? on page 263
:CALC{1-4}:MARK{1-10}:BWID:THR on page 264
:CALC{1-4}:PAR{1-4}:SEL on page 284

Equivalent key **[Marker Search] - Bandwidth**

:CALC{1-4}:MARK:COUP

Syntax :CALCulate {[1]2|3|4}[:SElected]:MARKer:COUPle {ON|OFF|1|0}
:CALCulate {[1]2|3|4}[:SElected]:MARKer:COUPle?

Description For channel 1 (:CALC1) to channel 4 (:CALC4), turns ON/OFF the marker coupling between traces.

Parameters

	Description
ON or 1 (preset value)	Turns ON the marker coupling.
OFF or 0	Turns OFF the marker coupling.

Query response {1|0}<newline><^END>

Example of use
10 OUTPUT 717;":CALC1:MARK:COUP OFF"
20 OUTPUT 717;":CALC1:MARK:COUP?"
30 ENTER 717;A

Equivalent key **[Marker Fctn] - Couple**

:CALC{1-4}:MARK:FUNC:DOM

Syntax :CALCulate{[1]|2|3|4}[[:SElected]:MARKer:FUNcTion:DOMain[:STATe] {ON|OFF|1|0}
:CALCulate{[1]|2|3|4}[[:SElected]:MARKer:FUNcTion:DOMain[:STATe]?

Description For channel 1 (:CALC1) to channel 4 (:CALC4), sets whether to use an arbitrary range when executing the marker search.

When the trace coupling is off, the active trace is the target to be set.

Parameters

	Description
ON or 1	Specifies an arbitrary range*1.
OFF or 0 (preset value)	Specifies the entire sweep range.

*1. Use the :CALC{1-4}:MARK:FUNC:DOM:STAR command and the :CALC{1-4}:MARK:FUNC:DOM:STOP command to specify a range.

Query response {1|0}<newline><^END>

Example of use

```
10 OUTPUT 717;":CALC1:MARK:FUNC:DOM ON"
20 OUTPUT 717;":CALC1:MARK:FUNC:DOM?"
30 ENTER 717;A
```

Related commands :CALC{1-4}:MARK{1-10}:FUNC:EXEC on page 266
:CALC{1-4}:MARK:FUNC:DOM:COUP on page 244
:CALC{1-4}:MARK:FUNC:DOM:STAR on page 245
:CALC{1-4}:MARK:FUNC:DOM:STOP on page 246

Equivalent key **[Marker Search] - Search Range - Search Range [ON/OFF]**

:CALC{1-4}:MARK:FUNC:DOM:COUP

Syntax :CALCulate {[1]|2|3|4}[:SElected]:MARKer:FUNCtion:DOMain:COUple {ON|OFF|1|0}
 :CALCulate {[1]|2|3|4}[:SElected]:MARKer:FUNCtion:DOMain:COUple?

Description For channel 1 (:CALC1) to channel 4 (:CALC4), specifies whether to set the coupling of the marker search range for all traces.

Parameters

	Description
ON or 1 (preset value)	Specifies the search range with the trace coupling.
OFF or 0	Specifies the search range for each trace.

Query response {1|0}<newline><^END>

Example of use

```
10 OUTPUT 717; ":CALC1:MARK:FUNC:DOM:COUP OFF"
20 OUTPUT 717; ":CALC1:MARK:FUNC:DOM:COUP?"
30 ENTER 717;A
```

Related commands :CALC{1-4}:MARK:FUNC:DOM on page 243
 :CALC{1-4}:PAR{1-4}:SEL on page 284

Equivalent key **[Marker Search] - Search Range - Couple**

:CALC{1-4}:MARK:FUNC:DOM:STAR

Syntax :CALCulate{[1]|2|3|4}[:SELEcted]:MARKer:FUNcTion:DOMain:STARt <numeric>
:CALCulate{[1]|2|3|4}[:SELEcted]:MARKer:FUNcTion:DOMain:STARt?

Description For channel 1 (:CALC1) to channel 4 (:CALC4), sets the start value of the marker search range.

When the trace coupling is off, the active trace is the target to be set.

Parameters

	<numeric>
Description	The start value of the search range
Preset value	0
Unit	Hz (hertz), dBm or second

Query response {numeric}<newline><^END>

Example of use

```
10 OUTPUT 717;":CALC1:MARK:FUNC:DOM:STAR 1.7E9"
20 OUTPUT 717;":CALC1:MARK:FUNC:DOM:STAR?"
30 ENTER 717;A
```

Related commands :CALC{1-4}:MARK{1-10}:FUNC:EXEC on page 266
:CALC{1-4}:MARK:FUNC:DOM on page 243
:CALC{1-4}:MARK:FUNC:DOM:STOP on page 246

Equivalent key **[Marker Search] - Search Range - Start**

:CALC{1-4}:MARK:FUNC:DOM:STOP

Syntax :CALCulate {[1]2|3|4}[:SElected]:MARKer:FUNCtion:DOMain:STOP <numeric>
:CALCulate {[1]2|3|4}[:SElected]:MARKer:FUNCtion:DOMain:STOP?

Description For channel 1 (:CALC1) to channel 4 (:CALC4), sets the stop value of the marker search range.

When the trace coupling is off, the active trace is the target to be set.

Parameters

	<numeric>
Description	The stop value of the search range
Preset value	0
Unit	Hz (hertz), dBm or second

Query response {numeric}<newline><<^END>

Example of use

```
10 OUTPUT 717; ":CALC1:MARK:FUNC:DOM:STOP 1.8E9"
20 OUTPUT 717; ":CALC1:MARK:FUNC:DOM:STOP?"
30 ENTER 717;A
```

Related commands :CALC{1-4}:MARK{1-10}:FUNC:EXEC on page 266
:CALC{1-4}:MARK:FUNC:DOM on page 243
:CALC{1-4}:MARK:FUNC:DOM:STAR on page 245

Equivalent key **[Marker Search] - Search Range - Stop**

:CALC{1-4}:MARK:FUNC:MULT:PEXC

Syntax :CALCulate{[1]|2|3|4}[[:SELEcted]:MARKer:FUNCtion: MULTi:PEXCursion <numeric>
:CALCulate{[1]|2|3|4}[[:SELEcted]:MARKer:FUNCtion: MULTi:PEXCursion?

Description For the active trace of channel 1 (:CALC1) to channel 4 (:CALC4) (specified with the :CALC{1-4}:PAR{1-4}:SEL command), sets the lower limit for the peak excursion value of the multi peak search.

Parameters

	<numeric>
Description	Lower limit for the peak excursion value
Range	0 to 5E8
Preset value	3
Unit	Varies depending on the data format as follows: Logarithmic Magnitude: dB (decibel) Phase, Expand Phase, Positive Phase: ° (degree) Group Delay: s (second) Others: No unit

If the specified parameter is out of the allowable setup range, the minimum value (if the lower limit of the range is not reached) or the maximum value (if the upper limit of the range is exceeded) is set.

Query response {numeric}<newline><^END>

Example of use
10 OUTPUT 717;":CALC1:MARK:FUNC:MULT:PEXC 0.2"
20 OUTPUT 717;":CALC1:MARK:FUNC:MULT:PEXC?"
30 ENTER 717;A

Related commands :CALC{1-4}:MARK:FUNC:MULT:PPOL on page 248
:CALC{1-4}:MARK:FUNC:MULT:TYPE on page 252
:CALC{1-4}:PAR{1-4}:SEL on page 284

Equivalent key **[Marker Search] - Multi Peak - Peak Excursion**

:CALC{1-4}:MARK:FUNC:MULT:PPOL

Syntax :CALCulate {[1]2|3|4}[:SELEcted]:MARKer:FUNCtion: MULTi: PPOLarity
{POSitive|NEGative|BOTH}

:CALCulate {[1]2|3|4}[:SELEcted]:MARKer:FUNCtion: MULTi: PPOLarity?

Description For the active trace of channel 1 (:CALC1) to channel 4 (:CALC4) (specified with the :CALC{1-4}:PAR{1-4}:SEL command), selects the polarity of the peak to be searched with the multi peak search.

Parameters

	Description
POSitive (preset value)	Specifies the positive peak.
NEGative	Specifies the negative peak.
BOTH	Specifies both the positive peak and the negative peak.

Query response {POS|NEG|BOTH}<newline><^END>

Example of use

```

10  OUTPUT 717; ":CALC1:MARK1:FUNC:MULT:PPOL NEG"
20  OUTPUT 717; ":CALC1:MARK1:FUNC:MULT:PPOL?"
30  ENTER 717;A$

```

Related commands :CALC{1-4}:MARK:FUNC:MULT:PEXC on page 247

:CALC{1-4}:MARK:FUNC:MULT:TYPE on page 252

:CALC{1-4}:PAR{1-4}:SEL on page 284

Equivalent key **[Marker Search] - Multi Peak - Peak Polarity**

:CALC{1-4}:MARK:FUNC:MULT:TARG

Syntax :CALCulate{[1]|2|3|4}[[:SELEcted]:MARKer:FUNCtion: MULTi: TARGeT <numeric>
:CALCulate{[1]|2|3|4}[[:SELEcted]:MARKer:FUNCtion: MULTi: TARGeT?

Description For the active trace of channel 1 (:CALC1) to channel 4 (:CALC4) (specified with the :CALC{1-4}:PAR{1-4}:SEL command), sets the target value to be searched with the multi target search.

Parameters

	<numeric>
Description	Target value for target search
Range	-5E8 to 5E8
Preset value	0
Unit	Varies depending on the data format as follows: Logarithmic Magnitude: dB (decibel) Phase, Expand Phase, Positive Phase: ° (degree) Group Delay: s (second) Others: No unit

If the specified parameter is out of the allowable setup range, the minimum value (if the lower limit of the range is not reached) or the maximum value (if the upper limit of the range is exceeded) is set.

Query response {numeric}<newline><^END>

Example of use
10 OUTPUT 717;":CALC1:MARK1:FUNC:MULT:TARG -12.5"
20 OUTPUT 717;":CALC1:MARK1:FUNC:MULT:TARG?"
30 ENTER 717;A

Related commands :CALC{1-4}:MARK:FUNC:MULT:TTR on page 251
:CALC{1-4}:MARK:FUNC:MULT:TYPE on page 252
:CALC{1-4}:PAR{1-4}:SEL on page 284

Equivalent key **[Marker Search] - Multi Target - Target Value**

:CALC{1-4}:MARK:FUNC:MULT:TRAC

Syntax :CALCulate {[1]|2|3|4}[:SElected]:MARKer:FUNCtion: MULTi: TRACking
 {ON|OFF|1|0}
 :CALCulate {[1]|2|3|4}[:SElected]:MARKer:FUNCtion: MULTi: TRACking?

Description For the active trace of channel 1 (:CALC1) to channel 4 (:CALC4) (specified with the :CALC{1-4}:PAR{1-4}:SEL command), turns ON/OFF the search tracking (function to repeat the search for each sweep) of the multi target or peak search.

Parameters

	Description
ON or 1	Turns ON the search tracking.
OFF or 0 (preset value)	Turns OFF the search tracking.

Query response {1|0}<newline><^END>

Example of use
 10 OUTPUT 717; ":CALC1:MARK1:FUNC:MULT:TRAC ON"
 20 OUTPUT 717; ":CALC1:MARK1:FUNC:MULT:TRAC?"
 30 ENTER 717;A

Related commands :CALC{1-4}:MARK:FUNC:MULT:TYPE on page 252
 :CALC{1-4}:PAR{1-4}:SEL on page 284

Equivalent key **[Marker Search] - Tracking**

:CALC{1-4}:MARK:FUNC:MULT:TTR

Syntax :CALCulate{[1]|2|3|4}{[:SELEcted]:MARKer:FUNcTion: MULTi: TTRansition {POSitive|NEGative|BOTH}}

:CALCulate{[1]|2|3|4}{[:SELEcted]:MARKer:FUNcTion: MULTi: TTRansition?}

Description For the active trace of channel 1 (:CALC1) to channel 4 (:CALC4) (specified with the :CALC{1-4}:PAR{1-4}:SEL command), selects the transition type when performing the multi target search.

Parameters

	Description
POSitive	Specifies positive.
NEGative	Specifies negative.
BOTH (preset value)	Specifies both positive and negative.

Query response {POS|NEG|BOTH}<newline><^END>

Example of use

```
10 OUTPUT 717;":CALC1:MARK1:FUNC:MULT:TTR NEG"
20 OUTPUT 717;":CALC1:MARK1:FUNC:MULT:TTR?"
30 ENTER 717;A$
```

Related commands :CALC{1-4}:MARK:FUNC:MULT:TARG on page 249
:CALC{1-4}:MARK:FUNC:MULT:TYPE on page 252
:CALC{1-4}:PAR{1-4}:SEL on page 284

Equivalent key **[Marker Search] - Multi Target - Target Transition**

:CALC{1-4}:MARK:FUNC:MULT:TYPE

Syntax :CALCulate {[1]|2|3|4}[:SELEcted]:MARKer:FUNCtion:MULTi:
:TYPE {MAXimum|MINimum|PEAK|LPEak|RPEak|TARGet|LTARget|RTARget}
:CALCulate {[1]|2|3|4}[:SELEcted]:MARKer:FUNCtion: MULTI
:TYPE?

Description For the active trace of channel 1 (:CALC1) to channel 4 (:CALC4) (specified with the :CALC{1-4}:PAR{1-4}:SEL command), selects and turns on the multi search type.

Parameters

	Description
OFF	Turn off the multi search mode
PEAK	Turn on the multi peak search
TARGet	Turn on the multi target search

Query response {OFF|PEAK|TARG}<newline><<^END>

Example of use
10 OUTPUT 717; ":CALC1:MARK1:FUNC:MULT:TYPE PEAK"
20 OUTPUT 717; ":CALC1:MARK1:FUNC:MULT:TYPE?"
30 ENTER 717;A\$

Related commands :CALC{1-4}:MARK:FUNC:MULT:PEXC on page 247
:CALC{1-4}:MARK:FUNC:MULT:PPOL on page 248
:CALC{1-4}:MARK:FUNC:MULT:TARG on page 249
:CALC{1-4}:MARK:FUNC:MULT:TRAC on page 250
:CALC{1-4}:MARK:FUNC:MULT:TTR on page 251
:CALC{1-4}:PAR{1-4}:SEL on page 284

Equivalent key **[Marker Search] - Multi Peak - Search Multi Peak**
[Marker Search] - Multi Target - Search Multi Target

:CALC{1-4}:MARK:MATH:FLAT

Syntax :CALCulate{[1]|2|3|4}[:SELEcted]:MARKer:MATH:FLATness[:STATe] {ON|OFF|1|0}
:CALCulate{[1]|2|3|4}[:SELEcted]:MARKer:MATH:FLATness[:STATe]?

Description For the active trace of channel 1 (:CALC1) to channel 4 (:CALC4) (specified with the :CALC{1-4}:PAR{1-4}:SEL command), turn on and off the marker flatness function.

Parameters

	Description
ON or 1	Turns ON the marker flatness.
OFF or 0 (preset value)	Turns OFF the marker flatness.

Query response {1|0}<newline><^END>

Example of use
10 OUTPUT 717; ":CALC1:MARK:MATH:FLAT ON"
20 OUTPUT 717; ":CALC1:MARK:MATH:FLAT?"
30 ENTER 717;A

Related commands :CALC{1-4}:MARK:MATH:FLAT:DATA? on page 254

Equivalent key **[Marker Fctn] - Flatness**

:CALC{1-4}:MARK:MATH:FLAT:DATA?

Syntax :CALCulate {[1]|2|3|4}[:SElected]:MARKer:MATH:FLATness:DATA?

Description For the active trace of channel 1 (:CALC1) to channel 4 (:CALC4) (specified with the :CALC{1-4}:PAR{1-4}:SEL command), returns marker flatness data.

Query response

	Description
Numeric 1	Span
Numeric 2	Gain
Numeric 3	Slope
Numeric 4	Flatness

{numeric1} {numeric2} {numeric3} {numeric4}<newline><^END>

Example of use
10 OUTPUT 717; ":CALC1:MARK:MATH:FLAT:DATA?"
20 ENTER 717;A,B,C,D

Related commands :CALC{1-4}:MARK:MATH:FLAT on page 253

Equivalent key No equivalent key is available on the front panel.

:CALC{1-4}:MARK:MATH:FST

Syntax :CALCulate{[1]|2|3|4}[[:SELEcted]:MARKer:MATH:FSTatistics[:STATe] {ON|OFF|1|0}
:CALCulate{[1]|2|3|4}[[:SELEcted]:MARKer:MATH:FSTatistics[:STATe]?

Description For the active trace of channel 1 (:CALC1) to channel 4 (:CALC4) (specified with the :CALC{1-4}:PAR{1-4}:SEL command), turn on and off the filter statistics.

Parameters

	Description
ON or 1	Turns ON the filter statistics.
OFF or 0 (preset value)	Turns OFF the filter statistics.

Query response {1|0}<newline><^END>

Example of use
10 OUTPUT 717; ":CALC1:MARK:MATH:FST ON"
20 OUTPUT 717; ":CALC1:MARK:MATH:FST?"
30 ENTER 717;A

Related commands :CALC{1-4}:MARK:MATH:FST:DATA? on page 256

Equivalent key **[Marker Fctn] - RF Filter Stats**

:CALC{1-4}:MARK:MATH:FST:DATA?

Syntax :CALCulate {[1]|2|3|4}[:SElected]:MARKer:MATH:FSTatistics:DATA?

Description For the active trace of channel 1 (:CALC1) to channel 4 (:CALC4) (specified with the :CALC{1-4}:PAR{1-4}:SEL command), returns filter statistics data.

Query response

	Description
Numeric 1	Loss
Numeric 2	Ripple
Numeric 3	Attenuation

{numeric1} {numeric2} {numeric3}<newline><^END>

Example of use
10 OUTPUT 717; ":CALC1:MARK:MATH:FST:DATA?"
20 ENTER 717;A,B,C

Related commands :CALC{1-4}:MARK:MATH:FST on page 255

Equivalent key No equivalent key is available on the front panel.

:CALC{1-4}:MARK:MATH:STAT

Syntax :CALCulate{[1]|2|3|4}[:SELEcted]:MARKer:MATH:STATistics[:STATe] {ON|OFF|1|0}
:CALCulate{[1]|2|3|4}[:SELEcted]:MARKer:MATH:STATistics[:STATe]?

Description For the active trace of channel 1 (:CALC1) to channel 4 (:CALC4) (specified with the :CALC{1-4}:PAR{1-4}:SEL command), turn on and off the marker statistics function.

Parameters

	Description
ON or 1	Turns ON the marker statistics.
OFF or 0 (preset value)	Turns OFF the marker statistics.

Query response {1|0}<newline><^END>

Example of use
10 OUTPUT 717; ":CALC1:MARK:MATH:STAT ON"
20 OUTPUT 717; ":CALC1:MARK:MATH:STAT?"
30 ENTER 717;A

Related commands :CALC{1-4}:MARK:MATH:STAT:DATA? on page 258

Equivalent key **[Marker Fctn] - Statistics**

:CALC{1-4}:MARK:MATH:STAT:DATA?

Syntax :CALCulate {[1]|2|3|4}[:SElected]:MARKer:MATH:STATistics:DATA?

Description For the active trace of channel 1 (:CALC1) to channel 4 (:CALC4) (specified with the :CALC{1-4}:PAR{1-4}:SEL command), returns marker statistics data.

Query response

	Description
Numeric 1	Span
Numeric 2	Average
Numeric 3	Standard Deviation
Numeric 4	Peak to Peak

{numeric1} {numeric2} {numeric3} {numeric4}<newline><^END>

Example of use
10 OUTPUT 717; ":CALC1:MARK:MATH:STAT:DATA?"
20 ENTER 717;A,B,C,D

Related commands :CALC{1-4}:MARK:MATH:STAT on page 257

Equivalent key No equivalent key is available on the front panel.

:CALC{1-4}:MARK:NOTC

Syntax :CALCulate{[1]2|3|4}[[:SELEcted]:MARKer:NOTCh[:STATe] {ON|OFF|1|0}
:CALCulate{[1]2|3|4}[[:SELEcted]:MARKer:NOTCh[:STATe]?

Description For the active trace of channel 1 (:CALC1) to channel 4 (:CALC4) (specified with the :CALC{1-4}:PAR{1-4}:SEL command), turns ON/OFF the notch search result display.

Parameters

	Description
ON or 1	Turns ON the notch search result display.
OFF or 0 (preset value)	Turns OFF the notch search result display.

Query response {1|0}<newline><^END>

Example of use
10 OUTPUT 717;":CALC1:MARK:NOTC ON"
20 OUTPUT 717;":CALC1:MARK:NOTC?"
30 ENTER 717;A

Related commands :CALC{1-4}:PAR{1-4}:SEL on page 284
:CALC{1-4}:MARK{1-10}:NOTC:DATA? on page 274
:CALC{1-4}:MARK{1-10}:NOTC:THR on page 275

Equivalent key **[Marker Search] - Notch**

:CALC{1-4}:MARK:REF

Syntax :CALCulate {[1]|2|3|4}[:SElected]:MARKer:REFerence[:STATe] {ON|OFF|1|0}
:CALCulate {[1]|2|3|4}[:SElected]:MARKer:REFerence[:STATe]?

Description For the active trace of channel 1 (:CALC1) to channel 4 (:CALC4) (specified with the :CALC{1-4}:PAR{1-4}:SEL command), turns ON/OFF the reference marker mode.
The reference marker mode is turned on or off when you turn on or off the display of the reference marker.

Parameters

	Description
ON or 1	Turns ON the reference marker mode.
OFF or 0 (preset value)	Turns OFF the reference marker mode.

Query response {1|0}<newline><^END>

Example of use
10 OUTPUT 717; ":CALC1:MARK:REF ON"
20 OUTPUT 717; ":CALC1:MARK:REF?"
30 ENTER 717;A

Related commands :CALC{1-4}:PAR{1-4}:SEL on page 284
:CALC{1-4}:MARK{1-10} on page 261

Equivalent key **[Marker] - Ref Maker Mode**

:CALC{1-4}:MARK{1-10}

Syntax :CALCulate{[1]|2|3|4}{:SELEcted}:MARKer{[1]|2|3|4|5|6|7|8|9|10}{[:STATe]
{ON|OFF|1|0}}
:CALCulate{[1]|2|3|4}{:SELEcted}:MARKer{[1]|2|3|4|5|6|7|8|9|10}{[:STATe]?

Description For the active trace of channel 1 (:CALC1) to channel 4 (:CALC4) (specified with the :CALC{1-4}:PAR{1-4}:SEL command), turns ON/OFF the display of marker 1 (:MARK1) to marker 9 (:MARK9) and reference marker (:MARK10).
The display of the reference marker is turned on or off when you turn on or off the reference marker mode.

Parameters

	Description
ON or 1	Turns ON the display of the marker.
OFF or 0 (preset value)	Turns OFF the display of the marker.

Query response {1|0}<newline><^END>

Example of use
10 OUTPUT 717;":CALC1:MARK1 ON"
20 OUTPUT 717;":CALC1:MARK1?"
30 ENTER 717;A

Related commands :CALC{1-4}:PAR{1-4}:SEL on page 284
:CALC{1-4}:MARK:REF on page 260

Equivalent key When turning ON the display of the marker
[Marker] - Marker 1|Marker 2|Marker 3|Marker 4|Ref Marker
[Marker] - More Markers - Marker 5|Marker 6|Marker 7|Marker 8|Marker 9

NOTE When performing the operation from the front panel, a marker set to ON is automatically set to the active marker.

When turning OFF the display of the marker
[Marker] - Clear Marker Menu - Marker 1|Marker 2|Marker 3|Marker 4|Marker 5|Marker 6|Marker 7|Marker 8|Marker 9|Ref Marker

:CALC{1-4}:MARK{1-10}:ACT

Syntax	:CALCulate {[1] 2 3 4}[:SELEcted]:MARKer {[1] 2 3 4 5 6 7 8 9 10}:ACTivate
Description	For the active trace of channel 1 (:CALC1) to channel 4 (:CALC4) (specified with the :CALC{1-4}:PAR{1-4}:SEL command), sets marker 1 (:MARK1) to marker 9 (:MARK9) and reference marker (:MARK10) to the active marker. (No query)

NOTE If you set a marker set to OFF to the active marker, it is automatically set to ON.

Example of use 10 OUTPUT 717; ":CALC1:MARK1:ACT"

Related commands :DISP:WIND{1-4}:ACT on page 316
 :CALC{1-4}:PAR{1-4}:SEL on page 284

Equivalent key **[Marker] - Marker 1|Marker 2|Marker 3|Marker 4|Ref Marker**
 [Marker] - More Markers - Marker 5|Marker 6|Marker 7|Marker 8|Marker 9

:CALC{1-4}:MARK{1-10}:BWID:DATA?

Syntax :CALCulate{[1]|2|3|4}[:SELEcted]:MARKer{[1]|2|3|4|5|6|7|8|9|10}:BWIDth:DATA?

Description For the active trace of channel 1 (:CALC1) to channel 4 (:CALC4) (specified with the :CALC{1-4}:PAR{1-4}:SEL command), reads out the bandwidth search result of marker 1 (:MARK1) to marker 9 (:MARK9) and reference marker (:MARK10).

If the bandwidth search is impossible, an error occurs and the command is ignored. In this case, no query response is obtained. (Query only)

Query response {numeric 1},{numeric 2},{numeric 3},{numeric 4}<newline><<^END>

	Description
{numeric 1}	The bandwidth.
{numeric 2}	The center frequency.
{numeric 3}	The Q value.
{numeric 4}	The loss.

Example of use
10 OUTPUT 717;" :CALC1:MARK1:BWID:DATA?"
20 ENTER 717;A,B,C,D

Related commands :CALC{1-4}:MARK:BWID on page 241
:CALC{1-4}:MARK{1-10}:BWID:THR on page 264
:CALC{1-4}:PAR{1-4}:SEL on page 284

Equivalent key No equivalent key is available on the front panel.

:CALC{1-4}:MARK{1-10}:BWID:THR

Syntax :CALCulate{[1]|2|3|4}[:SElected]:MARKer{[1]|2|3|4|5|6|7|8|9|10}:BWIDth: THReshold <numeric>

:CALCulate{[1]|2|3|4}[:SElected]:MARKer{[1]|2|3|4|5|6|7|8|9|10}:BWIDth: THReshold?

Description For the active trace of channel 1 (:CALC1) to channel 4 (:CALC4) (specified with the :CALC{1-4}:PAR{1-4}:SEL command), sets the bandwidth definition value of marker 1 (:MARK1) to marker 9 (:MARK9) and reference marker (:MARK10).

Parameters

	<numeric>
Description	Bandwidth definition value
Range	-5E8 to 5E8
Preset value	-3
Unit	Varies depending on the data format as follows: Logarithmic Magnitude: dB (decibel) Phase, Expand Phase, Positive Phase: ° (degree) Group Delay: s (second) Others: No unit

If the specified parameter is out of the allowable setup range, the minimum value (if the lower limit of the range is not reached) or the maximum value (if the upper limit of the range is exceeded) is set.

Query response {numeric}<newline><^END>

Example of use

```
10 OUTPUT 717; ":CALC1:MARK1:BWID:THR 6"
20 OUTPUT 717; ":CALC1:MARK1:BWID:THR?"
30 ENTER 717;A
```

Related commands :CALC{1-4}:MARK:BWID on page 241
:CALC{1-4}:PAR{1-4}:SEL on page 284

Equivalent key **[Marker Search] - Bandwidth Value**

:CALC{1-4}:MARK{1-10}:DISC

Syntax :CALCulate{[1]|2|3|4}[[:SELEcted]:MARKer{[1]|2|3|4|5|6|7|8|9|10}]:DISCrete
{ON|OFF|1|0}

:CALCulate{[1]|2|3|4}[[:SELEcted]:MARKer{[1]|2|3|4|5|6|7|8|9|10}]:DISCrete?

Description For the active trace of channel 1 (:CALC1) to channel 4 (:CALC4) (specified with the :CALC{1-4}:PAR{1-4}:SEL command), turns ON/OFF the discrete mode (mode in which the marker moves only at the measurement points) with marker 1 (:MARK1) to marker 9 (:MARK9) and reference marker (:MARK10).

Parameters

	Description
ON or 1	Turn OFF the discrete mode.
OFF or 0 (preset value)	Turns OFF the discrete mode.

Query response {1|0}<newline><^END>

Example of use

```
10 OUTPUT 717;":CALC1:MARK1:DISC OFF"
20 OUTPUT 717;":CALC1:MARK1:DISC?"
30 ENTER 717;A
```

Equivalent key **[Marker Fctn] - Discrete**

:CALC{1-4}:MARK{1-10}:FUNC:EXEC

Syntax	:CALCulate {[1] 2 3 4}[:SELEcted]:MARKer {[1] 2 3 4 5 6 7 8 9 10}:FUNCtion:EXECute
Description	<p>For the active trace of channel 1 (:CALC1) to channel 4 (:CALC4) (specified with the :CALC{1-4}:PAR{1-4}:SEL command), executes the search with marker 1 (:MARK1) to marker 9 (:MARK9) and reference marker (:MARK10).</p> <p>To specify the type of the search, use the :CALC{1-4}:MARK{1-10}:FUNC:TYPE command. (No query)</p>
Example of use	10 OUTPUT 717; ":CALC1:MARK1:FUNC:EXEC"
Related commands	:CALC{1-4}:MARK{1-10}:FUNC:TYPE on page 272 :CALC{1-4}:PAR{1-4}:SEL on page 284 :CALC{1-4}:MARK:FUNC:DOM on page 243
Equivalent key	[Marker Search] - Max Min [Marker Search] - Peak - Search Peak Search Left Search Right [Marker Search] - Target - Search Target Search Left Search Right

NOTE When performing the operation from the front panel, you select the search type and execute the search at the same time.

:CALC{1-4}:MARK{1-10}:FUNC:PEXC

Syntax :CALCulate{[1]|2|3|4}[:SELEcted]:MARKer{[1]|2|3|4|5|6|7|8|9|10}:FUNCtion:
PEXCursion <numeric>

:CALCulate{[1]|2|3|4}[:SELEcted]:MARKer{[1]|2|3|4|5|6|7|8|9|10}:FUNCtion:
PEXCursion?

Description For the active trace of channel 1 (:CALC1) to channel 4 (:CALC4) (specified with the :CALC{1-4}:PAR{1-4}:SEL command), sets the lower limit for the peak excursion value of marker 1 (:MARK1) to marker 9 (:MARK9) and reference marker (:MARK10).

Parameters

	<numeric>
Description	Lower limit for the peak excursion value
Range	0 to 5E8
Preset value	3
Unit	Varies depending on the data format as follows: Logarithmic Magnitude: dB (decibel) Phase, Expand Phase, Positive Phase: ° (degree) Group Delay: s (second) Others: No unit

If the specified parameter is out of the allowable setup range, the minimum value (if the lower limit of the range is not reached) or the maximum value (if the upper limit of the range is exceeded) is set.

Query response {numeric}<newline><^END>

Example of use
10 OUTPUT 717;":CALC1:MARK1:FUNC:PEXC 0.2"
20 OUTPUT 717;":CALC1:MARK1:FUNC:PEXC?"
30 ENTER 717;A

Related commands :CALC{1-4}:MARK{1-10}:FUNC:PPOL on page 268
:CALC{1-4}:MARK{1-10}:FUNC:TYPE on page 272
:CALC{1-4}:PAR{1-4}:SEL on page 284

Equivalent key **[Marker Search] - Peak - Peak Excursion**

:CALC{1-4}:MARK{1-10}:FUNC:PPOL

Syntax :CALCulate {[1]|2|3|4}[:SELEcted]:MARKer {[1]|2|3|4|5|6|7|8|9|10}:FUNCtion: PPOLarity {POSitive|NEGative|BOTH}

:CALCulate {[1]|2|3|4}[:SELEcted]:MARKer {[1]|2|3|4|5|6|7|8|9|10}:FUNCtion: PPOLarity?

Description For the active trace of channel 1 (:CALC1) to channel 4 (:CALC4) (specified with the :CALC{1-4}:PAR{1-4}:SEL command), selects the polarity of the peak to be searched with marker 1 (:MARK1) to marker 9 (:MARK9) and reference marker (:MARK10).

Parameters

	Description
POSitive (preset value)	Specifies the positive peak.
NEGative	Specifies the negative peak.
BOTH	Specifies both the positive peak and the negative peak.

Query response {POS|NEG|BOTH}<newline><^END>

Example of use

```
10 OUTPUT 717; ":CALC1:MARK1:FUNC:PPOL NEG"
20 OUTPUT 717; ":CALC1:MARK1:FUNC:PPOL?"
30 ENTER 717;A$
```

Related commands :CALC{1-4}:MARK{1-10}:FUNC:PEXC on page 267
:CALC{1-4}:MARK{1-10}:FUNC:TYPE on page 272
:CALC{1-4}:PAR{1-4}:SEL on page 284

Equivalent key **[Marker Search] - Peak - Peak Polarity**

:CALC{1-4}:MARK{1-10}:FUNC:TARG

Syntax :CALCulate{[1]|2|3|4}[:SElected]:MARKer{[1]|2|3|4|5|6|7|8|9|10}:FUNCtion: TARGet <numeric>
:CALCulate{[1]|2|3|4}[:SElected]:MARKer{[1]|2|3|4|5|6|7|8|9|10}:FUNCtion: TARGet?

Description For the active trace of channel 1 (:CALC1) to channel 4 (:CALC4) (specified with the :CALC{1-4}:PAR{1-4}:SEL command), sets the target value to be searched with marker 1 (:MARK1) to marker 9 (:MARK9) and reference marker (:MARK10).

Parameters

	<numeric>
Description	Target value for target search
Range	-5E8 to 5E8
Preset value	0
Unit	Varies depending on the data format as follows: Logarithmic Magnitude: dB (decibel) Phase, Expand Phase, Positive Phase: ° (degree) Group Delay: s (second) Others: No unit

If the specified parameter is out of the allowable setup range, the minimum value (if the lower limit of the range is not reached) or the maximum value (if the upper limit of the range is exceeded) is set.

Query response {numeric}<newline><^END>

Example of use
10 OUTPUT 717;":CALC1:MARK1:FUNC:TARG -12.5"
20 OUTPUT 717;":CALC1:MARK1:FUNC:TARG?"
30 ENTER 717;A

Related commands :CALC{1-4}:MARK{1-10}:FUNC:TTR on page 271
:CALC{1-4}:MARK{1-10}:FUNC:TYPE on page 272
:CALC{1-4}:PAR{1-4}:SEL on page 284

Equivalent key **[Marker Search] - Target - Target Value**

:CALC{1-4}:MARK{1-10}:FUNC:TRAC

Syntax :CALCulate {[1]|2|3|4}[:SElected]:MARKer {[1]|2|3|4|5|6|7|8|9|10}:FUNCtion:TRACking {ON|OFF|1|0}

:CALCulate {[1]|2|3|4}[:SElected]:MARKer {[1]|2|3|4|5|6|7|8|9|10}:FUNCtion:TRACking?

Description For the active trace of channel 1 (:CALC1) to channel 4 (:CALC4) (specified with the :CALC{1-4}:PAR{1-4}:SEL command), turns ON/OFF the search tracking (function to repeat the search for each sweep) of marker 1 (:MARK1) to marker 9 (:MARK9) and reference marker (:MARK10).

Parameters

	Description
ON or 1	Turns ON the search tracking.
OFF or 0 (preset value)	Turns OFF the search tracking.

Query response {1|0}<newline><^END>

Example of use

```

10  OUTPUT 717; ":CALC1:MARK1:FUNC:TRAC ON"
20  OUTPUT 717; ":CALC1:MARK1:FUNC:TRAC?"
30  ENTER 717;A

```

Related commands :CALC{1-4}:MARK{1-10}:FUNC:EXEC on page 266
:CALC{1-4}:MARK{1-10}:FUNC:TYPE on page 272
:CALC{1-4}:PAR{1-4}:SEL on page 284

Equivalent key **[Marker Search] - Tracking**

:CALC{1-4}:MARK{1-10}:FUNC:TTR

Syntax :CALCulate{[1]|2|3|4}[[:SElected]:MARKer{[1]|2|3|4|5|6|7|8|9|10}:FUNCtion:
TTRansition {POSitive| NEGative|BOTH}
:CALCulate{[1]|2|3|4}[[:SElected]:MARKer{[1]|2|3|4|5|6|7|8|9|10}:FUNCtion:
TTRansition?

Description For the active trace of channel 1 (:CALC1) to channel 4 (:CALC4) (specified with the :CALC{1-4}:PAR{1-4}:SEL command), selects the transition type when performing the target search with marker 1 (:MARK1) to marker 9 (:MARK9) and reference marker (:MARK10).

Parameters

	Description
POSitive	Specifies positive.
NEGative	Specifies negative.
BOTH (preset value)	Specifies both positive and negative.

Query response {POS|NEG|BOTH}<newline><^END>

Example of use
10 OUTPUT 717;":CALC1:MARK1:FUNC:TTR NEG"
20 OUTPUT 717;":CALC1:MARK1:FUNC:TTR?"
30 ENTER 717;A\$

Related commands :CALC{1-4}:MARK{1-10}:FUNC:TARG on page 269
:CALC{1-4}:MARK{1-10}:FUNC:TYPE on page 272
:CALC{1-4}:PAR{1-4}:SEL on page 284

Equivalent key **[Marker Search] - Target - Target Transition**

:CALC{1-4}:MARK{1-10}:FUNC:TYPE

Syntax :CALCulate {[1]|2|3|4}[:SELEcted]:MARKer {[1]|2|3|4|5|6|7|8|9|10}:FUNCtion
:TYPE {MAXimum|MINimum|PEAK|LPEak|RPEak|TARGet|LTARget|RTARget}
:CALCulate {[1]|2|3|4}[:SELEcted]:MARKer {[1]|2|3|4|5|6|7|8|9|10}:FUNCtion
:TYPE?

Description For the active trace of channel 1 (:CALC1) to channel 4 (:CALC4) (specified with the :CALC{1-4}:PAR{1-4}:SEL command), selects the search type of marker 1 (:MARK1) to marker 9 (:MARK9) and reference marker (:MARK10).

Parameters

	Description
MAXimum (preset value)	Specifies the maximum value search.
MINimum	Specifies the minimum value search.
PEAK	Specifies the maximum positive (minimum negative) peak ^{*1} search.
LPEak	Specifies the peak ^{*1} search to the left from the marker position.
RPEak	Specifies the peak ^{*1} search to the right from the marker position.
TARGet	Specifies the search for the target ^{*2} closest to the current marker position.
LTARget	Specifies the target ^{*2} search to the left from the marker position.
RTARget	Specifies the target ^{*2} search to the right from the marker position.

*1. To specify the conditions of the peak, use the :CALC{1-4}:MARK{1-10}:FUNC:PEXC command and the :CALC{1-4}:MARK{1-10}:FUNC:PPOL command.

*2. To specify the conditions of the target, use the :CALC{1-4}:MARK{1-10}:FUNC:TARG command and the :CALC{1-4}:MARK{1-10}:FUNC:TTR command.

Query response {MAX|MIN|PEAK|LPE|RPE|TARG|LTAR|RTAR}<newline><<^END>

Example of use
10 OUTPUT 717; ":CALC1:MARK1:FUNC:TYPE PEAK"
20 OUTPUT 717; ":CALC1:MARK1:FUNC:TYPE?"
30 ENTER 717;A\$

Related commands :CALC{1-4}:MARK{1-10}:FUNC:EXEC on page 266
:CALC{1-4}:MARK{1-10}:FUNC:PEXC on page 267
:CALC{1-4}:MARK{1-10}:FUNC:PPOL on page 268
:CALC{1-4}:MARK{1-10}:FUNC:TARG on page 269
:CALC{1-4}:MARK{1-10}:FUNC:TTR on page 271
:CALC{1-4}:PAR{1-4}:SEL on page 284

Equivalent key **[Marker Search] - Max|Min**
[Marker Search] - Peak - Search Peak|Search Left|Search Right

[Marker Search] - Target - Search Target|Search Left|Search Right

NOTE

When performing the operation from the front panel, you select the search type and execute the search at the same time.

:CALC{1-4}:MARK{1-10}:NOTC:DATA?

Syntax :CALCulate {[1]|2|3|4}[:SElected]:MARKer {[1]|2|3|4|5|6|7|8|9|10}:NOTCh:DATA?

Description For the active trace of channel 1 (:CALC1) to channel 4 (:CALC4) (specified with the :CALC{1-4}:PAR{1-4}:SEL command), reads out the notch search result of marker 1 (:MARK1) to marker 9 (:MARK9) and reference marker (:MARK10).

If the notch search is impossible, an error occurs and the command is ignored.

In this case, no query response is obtained. (Query only)

Query response {value 1},{value 2},{value 3},{value 4}<newline><^END>

	Description
{value 1}	Bandwidth.
{value 2}	Center frequency.
{value 3}	Q value.
{value 4}	Loss.

Example of use

```
10 OUTPUT 717; ":CALC1:MARK1:NOTC:DATA?"
20 ENTER 717;A,B,C,D
```

Related commands :CALC{1-4}:PAR{1-4}:SEL on page 284
:CALC{1-4}:MARK:NOTC on page 259
:CALC{1-4}:MARK{1-10}:NOTC:THR on page 275

Equivalent key No equivalent key is available on the front panel.

:CALC{1-4}:MARK{1-10}:NOTC:THR

Syntax :CALCulate{[1]2|3|4}{[:SELEcted]:MARKer{[1]2|3|4|5|6|7|8|9|10}:NOTCh:THReshold
<value>
:CALCulate{[1]2|3|4}{[:SELEcted]:MARKer{[1]2|3|4|5|6|7|8|9|10}:NOTCh:THReshold?

Description For the active trace of channel 1 (:CALC1) to channel 4 (:CALC4) (specified with the :CALC{1-4}:PAR{1-4}:SEL command), sets the notch definition value of marker 1 (:MARK1) to marker 9 (:MARK9) and reference marker (:MARK10).

Parameters

	<value>
Description	Notch definition value
Range	-5E8 to 5E8
Preset value	-3
Unit	Varies depending on the data format as follows: Amplitude (MLOG): dB (decibel) Phase (PHAS), expanded phase (UPH), positive phase (PPH): ° (degree) Group delay (GDEL): s (second) Others: No unit

If the specified parameter is out of the allowable setup range, the minimum value (if the lower limit of the range is not reached) or the maximum value (if the upper limit of the range is exceeded) is set.

Query response {value}<newline><^END>

Example of use
10 OUTPUT 717;":CALC1:MARK1:NOTC:THR 5"
20 OUTPUT 717;":CALC1:MARK1:NOTC:THR?"
30 ENTER 717;A

Related commands :CALC{1-4}:PAR{1-4}:SEL on page 284
:CALC{1-4}:MARK:NOTC on page 259
:CALC{1-4}:MARK{1-10}:NOTC:DATA? on page 274

Equivalent key **[Marker Search] - Notch Value**

:CALC{1-4}:MARK{1-10}:SET

Syntax :CALCulate {[1]|2|3|4}[:SElected]:MARKer {[1]|2|3|4|5|6|7|8|9|10}:SET {START|STOP|CENTer|RLEVel|DELay}

Description For the active trace of channel 1 (:CALC1) to channel 4 (:CALC4) (specified with the :CALC{1-4}:PAR{1-4}:SEL command), sets the value of the specified item to the value of the position of marker 1 (:MARK1) to marker 9 (:MARK9) and reference marker (:MARK10).

Regardless of the ON/OFF of the reference marker mode (specified with the :CALC{1-4}:MARK:REF command), the value when the reference marker mode is OFF is always set. (No query)

Parameters

	Description
START	Sets the sweep start value to the stimulus value at the marker position.
STOP	Sets the sweep stop value to the stimulus value at the marker position.
CENTer	Sets the sweep center value to the stimulus value at the marker position.
RLEVel	Sets the reference line value to the response value at the marker position.
DELay	Sets the electrical delay time value to the group delay value at the marker position.

Example of use 10 OUTPUT 717;":CALC1:MARK1:SET CENT"

Related commands :CALC{1-4}:PAR{1-4}:SEL on page 284

:CALC{1-4}:MARK:REF on page 260

Equivalent key **[Marker Fctn] - Marker -> Start|Marker -> Stop|Marker -> Center|Marker -> Reference|Marker -> Delay**

:CALC{1-4}:MARK{1-10}:X

Syntax :CALCulate{[1]|2|3|4}{[:SELEcted]:MARKer{[1]|2|3|4|5|6|7|8|9|10}:X <numeric>
:CALCulate{[1]|2|3|4}{[:SELEcted]:MARKer{[1]|2|3|4|5|6|7|8|9|10}:X?

Description For the active trace of channel 1 (:CALC1) to channel 4 (:CALC4) (specified with the :CALC{1-4}:PAR{1-4}:SEL command), sets the stimulus value of marker 1 (:MARK1) to marker 9 (:MARK9) and reference marker (:MARK10).

Parameters

	<numeric>
Description	Stimulus value ^{*1}
Range	Sweep start value to sweep stop value ^{*2}
Preset value	Sweep start value ^{*3}
Unit	Hz (hertz), dBm or second

- *1. When the reference marker mode is ON (ON is specified with the :CALC{1-4}:MARK:REF command), it is the value relative to the reference marker.
- *2. When the span value of the sweep range is 0, the range is from 0 to sweep time value.
- *3. When the span value of the sweep range is 0, the unit is 0.

If the specified parameter is out of the allowable setup range, the minimum value (if the lower limit of the range is not reached) or the maximum value (if the upper limit of the range is exceeded) is set.

Query response {numeric}<newline><^END>

Example of use
10 OUTPUT 717;":CALC1:MARK1:X 1E9"
20 OUTPUT 717;":CALC1:MARK1:X?"
30 ENTER 717;A

Related commands :CALC{1-4}:MARK{1-10}:Y? on page 278
:CALC{1-4}:PAR{1-4}:SEL on page 284
:CALC{1-4}:MARK:REF on page 260

Equivalent key **[Marker] - Marker 1|Marker 2|Marker 3|Marker 4|Ref Marker**
[Marker] - More Markers - Marker 5|Marker 6|Marker 7|Marker 8|Marker 9

NOTE When performing the operation from the front panel, you turn ON the marker and set the stimulus value at the same time.

:CALC{1-4}:MARK{1-10}:Y?

Syntax :CALCulate {[1]|2|3|4}[:SElected]:MARKer {[1]|2|3|4|5|6|7|8|9|10}:Y?

Description For the active trace of channel 1 (:CALC1) to channel 4 (:CALC4) (specified with the :CALC{1-4}:PAR{1-4}:SEL command), reads out the response value of marker 1 (:MARK1) to marker 9 (:MARK9) and reference marker (:MARK10).
When the reference marker mode is ON (ON is specified with the :CALC{1-4}:MARK:REF command), the readout value is the value relative to the reference marker. (Query only)

Query response {numeric 1}, {numeric 2}<newline><^END>

	Description
{numeric 1}	Response value (primary value) at the marker position.
{numeric 2}	Response value (secondary value) at the marker position. Always 0 when the data format is not the Smith chart format or the polar format.

Example of use
10 OUTPUT 717; ":CALC1:MARK1:Y?"
30 ENTER 717;A,B

Related commands :CALC{1-4}:MARK{1-10}:X on page 277
:CALC{1-4}:PAR{1-4}:SEL on page 284
:CALC{1-4}:MARK:REF on page 260

Equivalent key No equivalent key is available on the front panel.

:CALC{1-4}:MATH:FUNC

Syntax :CALCulate{[1]|2|3|4}[[:SELEcted]:MATH:FUNCtion {NORMal|SUBTract|DIVide|ADD|MULTiply}
:CALCulate{[1]|2|3|4}[[:SELEcted]:MATH:FUNCtion?

Description For the active trace of channel 1 (:CALC1) to channel 4 (:CALC4) (specified with the :CALC{1-4}:PAR{1-4}:SEL command), selects the data trace display method (math method between measurement data and memory trace data).
The math result according to this setting is displayed on the data trace.

Parameters

	Description
NORMal (preset value)	Specifies <i>Data</i> (no math).
DIVide	Specifies <i>Data</i> / <i>Mem</i> .
MULTiply	Specifies <i>Data</i> × <i>Mem</i> .
SUBTract	Specifies <i>Data</i> - <i>Mem</i> .
ADD	Specifies <i>Data</i> + <i>Mem</i> .

Where *Data* is the measurement data and *Mem* is the data stored in the memory trace.

Query response {NORM|DIV|MULT|SUBT|ADD}<newline><^END>

Example of use
10 OUTPUT 717;":CALC1:MATH:FUNC DIV"
20 OUTPUT 717;":CALC1:MATH:FUNC?"
30 ENTER 717;A\$

Related commands :CALC{1-4}:PAR{1-4}:SEL on page 284

Equivalent key **[Display] - Data Math - OFF|Data / Mem|Data * Mem|Data – Mem|Data + Mem**

:CALC{1-4}:MATH:MEM

Syntax :CALCulate{[1]|2|3|4}[[:SELEcted]:MATH:MEMorize

Description For the active trace of channel 1 (:CALC1) to channel 4 (:CALC4) (specified with the :CALC{1-4}:PAR{1-4}:SEL command), copies the measurement data at the execution of the command to the memory trace. (No query)

Example of use 10 OUTPUT 717;":CALC1:MATH:MEM"

Related commands :CALC{1-4}:PAR{1-4}:SEL on page 284

Equivalent key **[Display] - Data → Mem**

:CALC{1-4}:MST

Syntax :CALCulate {[1]|2|3|4}[:SELEcted]:MSTatistics[:STATe] {ON|OFF|1|0}
:CALCulate {[1]|2|3|4}[:SELEcted]:MSTatistics[:STATe]?

Description For the active trace of channel 1 (:CALC1) to channel 4 (:CALC4) (specified with the :CALC{1-4}:PAR{1-4}:SEL command), turns ON/OFF the statistics value display (the mean value, the standard deviation, and the difference between the maximum value and the minimum value).

Parameters

	Description
ON or 1	Turns ON the statistics value display.
OFF or 0 (preset value)	Turns OFF the statistics value display.

Query response {1|0}<newline><^END>

Example of use

```
10 OUTPUT 717; ":CALC1:MST ON"
20 OUTPUT 717; ":CALC1:MST?"
30 ENTER 717;A
```

Related commands :CALC{1-4}:MST:DATA? on page 281
:CALC{1-4}:PAR{1-4}:SEL on page 284

Equivalent key **[Marker Fctn] - Statistics**

:CALC{1-4}:MST:DATA?

Syntax :CALCulate{[1]|2|3|4}[[:SElected]:MSTatistics:DATA?

Description For the active trace of channel 1 (:CALC1) to channel 4 (:CALC4) (specified with the :CALC{1-4}:PAR{1-4}:SEL command), reads out the statistics values (the mean value, the standard deviation, and the difference between the maximum value and the minimum value) display. (Query only)

Query response {numeric 1},{numeric 2},{numeric 3}<newline><<^END>

	Description
{numeric 1}	Mean value
{numeric 2}	Standard deviation
{numeric 3}	Difference between the maximum value and the minimum value (Peak to Peak)

Example of use
10 OUTPUT 717;":CALC1:MST:DATA?"
20 ENTER 717;A,B,C

Related commands :CALC{1-4}:MST on page 280
:CALC{1-4}:PAR{1-4}:SEL on page 284

Equivalent key No equivalent key is available on the front panel.

:CALC{1-4}:PAR:COUN

Syntax :CALCulate{[1]|2|3|4}:PARAmeter:COUNt <numeric>
:CALCulate{[1]|2|3|4}:PARAmeter:COUNt?

Description Sets the number of traces of channel 1 (:CALC1) to channel 4 (:CALC4).

Parameters

	<numeric>
Description	Number of traces
Range	1 to 4
Preset value	1
Resolution	1

If the specified parameter is out of the allowable setup range, the minimum value (if the lower limit of the range is not reached) or the maximum value (if the upper limit of the range is exceeded) is set.

Query response {numeric}<newline><^END>

Example of use
10 OUTPUT 717; ":CALC1:PAR:COUN 4"
20 OUTPUT 717; ":CALC1:PAR:COUN?"
30 ENTER 717;A

Equivalent key **[Display] - Num of Traces**

:CALC{1-4}:PAR{1-4}:DEF

Syntax :CALCulate{[1]|2|3|4}:PARAmeter{[1]|2|3|4}:DEFine {S11|S21|S12|S22}
:CALCulate{[1]|2|3|4}:PARAmeter{[1]|2|3|4}:DEFine?

Description Sets the measurement parameter of trace 1 (:PAR1) to trace 4 (:PAR4) of channel 1 (:CALC1) to channel 4 (:CALC4).

Parameters

	Description
S11 (preset value)	Specifies S11.
S21	Specifies S21.
S12	Specifies S12.
S22	Specifies S22.

Query response {S11|S21|S12|S22}<newline><^END>

Example of use

```
10 OUTPUT 717;":CALC1:PAR1:DEF S21"
20 OUTPUT 717;":CALC1:PAR1:DEF?"
30 ENTER 717;A$
```

Equivalent key **[Meas] - S11|S21|S12|S22**

:CALC{1-4}:PAR{1-4}:SEL

Syntax	:CALCulate{[1] 2 3 4}:PARAmeter{[1] 2 3 4}:SELect
Description	<p>Sets trace 1 (:PAR1) to trace 4 (:PAR4) of channel 1 (:CALC1) to channel 4 (:CALC4) to the active trace.</p> <p>You can set only the displayed trace to the active trace. If you execute this command trying to set a not displayed trace to the active trace, an error occurs and the command is ignored. (No query)</p>
Example of use	10 OUTPUT 717; ":CALC1:PAR1:SEL"
Related commands	:DISP:WIND{1-4}:ACT on page 316
Equivalent key	[Trace Prev] / [Trace Next]

:CALC{1-4}:RLIM

Syntax	:CALCulate{[1] 2 3 4}[:SELected]:RLIMit[:STATe] {ON OFF 1 0} :CALCulate{[1] 2 3 4}[:SELected]:RLIMit[:STATe]?
Description	For the active trace of channel 1 (:CALC1) to channel 4 (:CALC4) (specified with the :CALC{1-4}:PAR{1-4}:SEL command), turns ON/OFF the ripple test function.
Parameters	

	Description
ON or 1	Turns ON the ripple test function.
OFF or 0 (preset value)	Turns OFF the ripple test function.

Query response	{1 0}<newline><^END>
Example of use	<pre>10 OUTPUT 717; ":CALC1:RLIM ON" 20 OUTPUT 717; ":CALC1:RLIM?" 30 ENTER 717;A</pre>
Related commands	<p>:CALC{1-4}:PAR{1-4}:SEL on page 284</p> <p>:CALC{1-4}:RLIM:DATA on page 285</p> <p>:CALC{1-4}:RLIM:DISP:LINE on page 286</p> <p>:CALC{1-4}:RLIM:DISP:SEL on page 287</p> <p>:CALC{1-4}:RLIM:DISP:VAL on page 288</p> <p>:CALC{1-4}:RLIM:FAIL? on page 289</p> <p>:CALC{1-4}:RLIM:REP? on page 290</p>
Equivalent key	[Analysis] - Ripple Limit - Ripple Limit Test

:CALC{1-4}:RLIM:DATA

Syntax :CALCulate{[1]2|3|4}[:SELEcted]:RLIMit:DATA <numeric 1>,...,<numeric 1+(N×4)>
:CALCulate{[1]2|3|4}[:SELEcted]:RLIMit:DATA?

Description For the active trace of channel 1 (:CALC1) to channel 4 (:CALC4) (specified with the :CALC{1-4}:PAR{1-4}:SEL command), sets the ripple limit table.

The data transfer format when this command is executed depends on the setting with the :FORM:DATA command.

Parameters

	Description
<numeric 1>	The number of ripple limit bands. (0 to 12)
<numeric 1+(n×4)-3>	The type of the n-th ripple limit band. Specify an integer 0 to 1: 0: Off 1: On
<numeric 1+(n×4)-2>	The value on the horizontal axis (frequency/power/time) of the start point of the n-th line.
<numeric 1+(n×4)-1>	The value on the horizontal axis (frequency/power/time) of the end point of the n-th line.
<numeric 1+(n×4)>	The value of maximum ripple (dB) range.

Where N is the number of lines (specified with <numeric 1>) and n is an integer between 1 and N.

If you set the number of lines to 0 (clear the limit table), this command needs only <numeric 1> as the parameter.

Query response {numeric 1},...,{numeric 1+(N×4)}<newline><^END>

Example of use

```

10 DIM B(1:2,1:4)
20 OUTPUT 717;":CALC1:RLIM:DATA 2,1,1E9,3E9,3,1,5E9,7E9,3"
30 OUTPUT 717;":CALC1:RLIM:DATA?"
40 ENTER 717;A,B(*)

10 OUTPUT 717;":CALC1:RLIM:DATA 0" ! Clear Ripple Limit Table

```

Related commands :CALC{1-4}:PAR{1-4}:SEL on page 284
:CALC{1-4}:RLIM on page 284

Equivalent key **[Analysis] - Ripple Limit - Edit Ripple Limit - Add**

:CALC{1-4}:RLIM:DISP:LINE

Syntax :CALCulate{[1][2][3][4]}[:SELEcted]:RLIMit:DISPlay:LINE {ON|OFF|1|0}
 :CALCulate{[1][2][3][4]}[:SELEcted]:RLIMit:DISPlay:LINE?

Description For the active trace of channel 1 (:CALC1) to channel 4 (:CALC4) (specified with the :CALC{1-4}:PAR{1-4}:SEL command), turns ON/OFF the ripple limit line display.

Parameters

	Description
ON or 1	Turns ON the ripple limit line display.
OFF or 0 (preset value)	Turns OFF the ripple limit line display.

Query response {1|0}<newline><^END>

Example of use
 10 OUTPUT 717; ":CALC1:RLIM:DISP:LINE ON"
 20 OUTPUT 717; ":CALC1:RLIM:DISP:LINE?"
 30 ENTER 717;A

Related commands :CALC{1-4}:PAR{1-4}:SEL on page 284
 :CALC{1-4}:RLIM on page 284
 :CALC{1-4}:RLIM:DISP:SEL on page 287
 :CALC{1-4}:RLIM:DISP:VAL on page 288

Equivalent key **[Analysis] - Ripple Limit - Ripple Limit**

:CALC{1-4}:RLIM:DISP:SEL

Syntax :CALCulate{[1]2|3|4}{[:SElected]:RLIMit:DISPlay:SElect <numeric>
:CALCulate{[1]2|3|4}{[:SElected]:RLIMit:DISPlay:SElect?

Description For channel 1 (:CALC1) to channel 4 (:CALC4) (specified with the :CALC{1-4}:PAR{1-4}:SEL command), sets the ripple limit band for ripple value display.

Parameters

	<numeric>
Description	The ripple limit band.
Range	1 to 12
Preset value	1

Query response {numeric}<newline><^END>

Example of use
 10 OUTPUT 717;":CALC1:RLIM:DISP:SEL 5"
 20 OUTPUT 717;":CALC1:RLIM:DISP:SEL?"
 30 ENTER 717;A

Related commands :CALC{1-4}:PAR{1-4}:SEL on page 284
 :CALC{1-4}:RLIM on page 284
 :CALC{1-4}:RLIM:DISP:LINE on page 286
 :CALC{1-4}:RLIM:DISP:VAL on page 288

Equivalent key **[Analysis] - Ripple Limit - Ripple Band**

:CALC{1-4}:RLIM:DISP:VAL

Syntax :CALCulate{[1][2][3][4]}[:SElected]:RLIMit:DISPlay:VALue {OFF|ABS|MAR}
:CALCulate{[1][2][3][4]}[:SElected]:RLIMit:DISPlay:VALue?

Description For the active trace of channel 1 (:CALC1) to channel 4 (:CALC4) (specified with the :CALC{1-4}:PAR{1-4}:SEL command), selects the display type for the ripple value.

Parameters

	Description
OFF (preset value)	Specifies the display off.
ABS	Specifies the absolute value for display type.
MAR	Specifies the margin for display type.

Query response {OFF|ABS|MAR}<newline><^END>

Example of use
 10 OUTPUT 717;":CALC1:RLIM:DISP:VAL ABS"
 20 OUTPUT 717;":CALC1:RLIM:DISP:VAL?"
 30 ENTER 717;A\$

Related commands :CALC{1-4}:PAR{1-4}:SEL on page 284
 :CALC{1-4}:RLIM on page 284
 :CALC{1-4}:RLIM:DISP:LINE on page 286
 :CALC{1-4}:RLIM:DISP:SEL on page 287

Equivalent key **[Analysis] - Ripple Limit - Ripple Value - OFF | Absolute | Margin**

:CALC{1-4}:RLIM:FAIL?

Syntax :CALCulate{[1]|2|3|4}[:SElected]:RLIMit:FAIL?

Description For the active trace of channel 1 (:CALC1) to channel 4 (:CALC4) (specified with the :CALC{1-4}:PAR{1-4}:SEL command), reads out the ripple test result. (Query only)

Query response {1|0}<newline><^END>

	Description
1	The ripple test result is FAIL.
0	The ripple test result is PASS.

When the ripple test is set to OFF, 0 is always read out.

Example of use
10 OUTPUT 717;":CALC1:RLIM:FAIL?"
20 ENTER 717;A

Related commands :CALC{1-4}:PAR{1-4}:SEL on page 284
:CALC{1-4}:RLIM on page 284

Equivalent key No equivalent key is available on the front panel.

:CALC{1-4}:RLIM:REP?

Syntax :CALCulate{[1][2][3][4]}[:SElected]:RLIMit:REPort[:DATA]?

Description For the active trace of channel 1 (:CALC1) to channel 4 (:CALC4) (specified with the :CALC{1-4}:PAR{1-4}:SEL command), reads out the ripple value of the ripple test.
The data transfer format when this command is executed depends on the setting with the :FORM:DATA command. (Query only)

Query response {numeric 1},...,{numeric 1+N×3}<newline><^END>

	Description
<numeric 1>	Number of ripple limit line (1 to 12)
<numeric 1+(n×3)-2>	Number of ripple limit bands
<numeric 1+(n×3)-1>	Ripple value
<numeric 1+(n×3)>	Results of ripple test 0: Pass 1: Fail

Where N is the number of lines (specified with <numeric 1>) and n is an integer between 1 and 12.

Example of use

```
10 DIM B(1:2,1:3)
20 OUTPUT 717;":CALC1:RLIM:REP?"
30 ENTER 717;A,B(*)
```

Related commands :CALC{1-4}:PAR{1-4}:SEL on page 284

:CALC{1-4}:RLIM on page 284

Equivalent key No equivalent key is available on the front panel.

:CALC{1-4}:SMO

Syntax :CALCulate{[1]|2|3|4}[:SELEcted]:SMOothing[:STATe] {ON|OFF|1|0}
:CALCulate{[1]|2|3|4}[:SELEcted]:SMOothing[:STATe]?

Description For the active trace of channel 1 (:CALC1) to channel 4 (:CALC4) (specified with the :CALC{1-4}:PAR{1-4}:SEL command), turns ON/OFF the smoothing.

Parameters

	Description
ON or 1	Turns ON the smoothing.
OFF or 0 (preset value)	Turns OFF the smoothing.

Query response {1|0}<newline><^END>

Example of use
10 OUTPUT 717;":CALC1:SMO:STAT ON"
20 OUTPUT 717;":CALC1:SMO:STAT?"
30 ENTER 717;A

Related commands :CALC{1-4}:PAR{1-4}:SEL on page 284
:CALC{1-4}:SMO:APER on page 292

Equivalent key **[Avg] - Smoothing**

:CALC{1-4}:SMO:APER

Syntax :CALCulate {[1]2|3|4}[:SELEcted]:SMOothing:APERture <numeric>
 :CALCulate {[1]2|3|4}[:SELEcted]:SMOothing:APERture?

Description Sets the smoothing aperture for channel 1 (:CALC1) to channel 4 (:CALC4) (specified with the :CALC{1-4}:PAR{1-4}:SEL command).

Parameters

	<numeric>
Description	Percentage relative to the sweep span value
Range	0.05 to 25
Preset value	1.5
Unit	% (percent)
Resolution	1E-14

If the specified parameter is out of the allowable setup range, the minimum value (if the lower limit of the range is not reached) or the maximum value (if the upper limit of the range is exceeded) is set.

Query response {numeric}<newline><^END>

Example of use
 10 OUTPUT 717;":CALC1:SMO:APER 2.5"
 20 OUTPUT 717;":CALC1:SMO:APER?"
 30 ENTER 717;A

Related commands :CALC{1-4}:PAR{1-4}:SEL on page 284
 :CALC{1-4}:SMO on page 291

Equivalent key **[Avg] - Smo Aperture**

:CONT:HAND:A

Syntax :CONTrol:HANDler:A[:DATA] <numeric>

Description Outputs data to output port A (A0 to A7) of the handler I/O. Data is outputted as 8-bit binary using A0 as LSB and A7 as MSB. (No query)

For details about the handler I/O, see Chapter 10.

Parameters

	<numeric>
Description	Output data
Range	0 to 255
Resolution	1

If the specified parameter is out of the allowable setup range, the minimum value (if the lower limit of the range is not reached) or the maximum value (if the upper limit of the range is exceeded) is set.

Example of use 10 OUTPUT 717;":CONT:HAND:A 15"

Equivalent key No equivalent key is available on the front panel.

:CONT:HAND:B

Syntax :CONTrol:HANDler:B[:DATA] <numeric>

Description Outputs data to output port B (B0 to B7) of the handler I/O. Data is outputted as 8-bit binary using B0 as LSB and B7 as MSB. (No query)

For details about the handler I/O, see Chapter 10.

Parameters

	<numeric>
Description	Output data
Range	0 to 255
Resolution	1

If the specified parameter is out of the allowable setup range, the minimum value (if the lower limit of the range is not reached) or the maximum value (if the upper limit of the range is exceeded) is set.

Example of use 10 OUTPUT 717;":CONT:HAND:B 15"

Equivalent key No equivalent key is available on the front panel.

:CONT:HAND:C

Syntax :CONTrol:HANDler:C[:DATA] <numeric>
:CONTrol:HANDler:C[:DATA]?

Description When input/output port C of the handler I/O is set to the output port, outputs data to output port C (C0 to C3).
When input/output port C is set to the input port, reads out data inputted to port C (C0 to C3).
Data is outputted as 4-bit binary using C0 as LSB and C3 as MSB.
For details about the handler I/O, see Chapter 10.

Parameters

	<numeric>
Description	Output data/input data
Range	0 to 15
Resolution	1

If the specified parameter is out of the allowable setup range, the minimum value (if the lower limit of the range is not reached) or the maximum value (if the upper limit of the range is exceeded) is set.

Query response {numeric}<newline><^END>

Example of use

```
10 OUTPUT 717;":CONT:HAND:C:MODE OUTP"
20 OUTPUT 717;":CONT:HAND:C 15"

10 OUTPUT 717;":CONT:HAND:C:MODE INP"
20 OUTPUT 717;":CONT:HAND:C?"
30 ENTER 717;A
```

Related commands :CONT:HAND:C:MODE on page 295

Equivalent key No equivalent key is available on the front panel.

:CONT:HAND:C:MODE

Syntax :CONTRol:HANDler:C:MODE {INPut|OUTPut}
:CONTRol:HANDler:C:MODE?

Description Sets the input/output direction of port C of the handler I/O.
For details about the handler I/O, see Chapter 10.

Parameters

	Description
INPut (preset value)	Specifies input.
OUTPut	Specifies output.

Query response {INP|OUTP}<newline><^END>

Example of use
10 OUTPUT 717;":CONT:HAND:C:MODE OUTP"
20 OUTPUT 717;":CONT:HAND:C:MODE?"
30 ENTER 717;A\$

Related commands :CONT:HAND:C on page 294

Equivalent key No equivalent key is available on the front panel.

:CONT:HAND:D

Syntax :CONTrol:HANDler:D[:DATA] <numeric>
:CONTrol:HANDler:D[:DATA]?

Description When input/output port D of the handler I/O is set to the output port, outputs data to output port D (D0 to D3).
When input/output port D is set to the input port, reads out data inputted to port D (D0 to D3).
Data is outputted as 4-bit binary using D0 as LSB and D3 as MSB.
For details about the handler I/O, see Chapter 10.

Parameters

	<numeric>
Description	Output data/input data
Range	0 to 15
Resolution	1

If the specified parameter is out of the allowable setup range, the minimum value (if the lower limit of the range is not reached) or the maximum value (if the upper limit of the range is exceeded) is set.

Query response {numeric}<newline><^END>

Example of use

```
10 OUTPUT 717;":CONT:HAND:D:MODE OUTP"
20 OUTPUT 717;":CONT:HAND:D 15"

10 OUTPUT 717;":CONT:HAND:D:MODE INP"
20 OUTPUT 717;":CONT:HAND:D?"
30 ENTER 717;A
```

Related commands :CONT:HAND:D:MODE on page 297

Equivalent key No equivalent key is available on the front panel.

:CONT:HAND:D:MODE

Syntax :CONTRol:HANDler:C:MODE {INPut|OUTPut}
:CONTRol:HANDler:C:MODE?

Description Sets the input/output direction of port D of the handler I/O.
For details about the handler I/O, see Chapter 10.

Parameters

	Description
INPut (preset value)	Specifies input.
OUTPut	Specifies output.

Query response {INP|OUTP}<newline><^END>

Example of use
10 OUTPUT 717;":CONT:HAND:D:MODE OUTP"
20 OUTPUT 717;":CONT:HAND:D:MODE?"
30 ENTER 717;A\$

Related commands :CONT:HAND:D on page 296

Equivalent key No equivalent key is available on the front panel.

:CONT:HAND:E

Syntax :CONTrol:HANDler:E[:DATA] <numeric>
:CONTrol:HANDler:E[:DATA]?

Description When input/output port E (port C + port D) of the handler I/O is set to the output port, outputs data to output port E.
When input/output port E is set to the input port, reads out data inputted to port E.
Data is outputted as 8-bit binary using C0 as LSB and D3 as MSB.
For details about the handler I/O, see Chapter 10.

Parameters

	<numeric>
Description	Output data/input data
Range	0 to 255
Resolution	1

If the specified parameter is out of the allowable setup range, the minimum value (if the lower limit of the range is not reached) or the maximum value (if the upper limit of the range is exceeded) is set.

Query response {numeric}<newline><^END>

Example of use

```

10 OUTPUT 717;":CONT:HAND:C:MODE OUTP"
20 OUTPUT 717;":CONT:HAND:D:MODE OUTP"
30 OUTPUT 717;":CONT:HAND:E 128"

10 OUTPUT 717;":CONT:HAND:C:MODE INP"
20 OUTPUT 717;":CONT:HAND:D:MODE INP"
30 OUTPUT 717;":CONT:HAND:E?"
40 ENTER 717;A

```

Related commands :CONT:HAND:C:MODE on page 295
:CONT:HAND:D:MODE on page 297
:CONT:HAND:C on page 294
:CONT:HAND:D on page 296

Equivalent key No equivalent key is available on the front panel.

:CONT:HAND:F

Syntax :CONTrol:HANDler:F[:DATA] <numeric>

Description Outputs data to output port F (port A + port B) of the handler I/O. Data is outputted as 16-bit binary using A0 as LSB and B7 as MSB. (No query)

For details about the handler I/O, see Chapter 10.

Parameters

	<numeric>
Description	Output data
Range	0 to 65535
Resolution	1

If the specified parameter is out of the allowable setup range, the minimum value (if the lower limit of the range is not reached) or the maximum value (if the upper limit of the range is exceeded) is set.

Example of use 10 OUTPUT 717;":CONT:HAND:F 511"

Related commands :CONT:HAND:A on page 293

:CONT:HAND:B on page 293

Equivalent key No equivalent key is available on the front panel.

:CONT:HAND:IND:STAT

Syntax :CONTrol:HANDler[:EXTension]:INDex:STATe {ON|OFF|1|0}
:CONTrol:HANDler[:EXTension]:INDex:STATe?

Description Turns ON/OFF outputting the INDEX signal to B6 of the handler I/O.
For details about the handler I/O, see Chapter 10.

Parameters

	Description
ON or 1	Turns ON the INDEX signal output.
OFF or 0 (preset value)	Turns OFF the INDEX signal output.

Query response {1|0}<newline><^END>

Example of use
10 OUTPUT 717;":CONT:HAND:IND:STAT ON"
20 OUTPUT 717;":CONT:HAND:IND:STAT?"
30 ENTER 717;A

Related commands :CONT:HAND:RTR:STAT on page 301

Equivalent key No equivalent key is available on the front panel.

:CONT:HAND:OUTP{1-2}

Syntax :CONTrol:HANDler:OUTPut{[1]|2}[:DATA] {1|0}
:CONTrol:HANDler:OUTPut{[1]|2}[:DATA]?

Description Sets HIGH/LOW of OUTPUT1 (:OUTP1) or OUTPUT2 (:OUTP2) of the handler I/O.
For details about the handler I/O, see Chapter 10.

Parameters

	Description
1	Specifies LOW.
0	Specifies HIGH.

Query response {1|0}<newline><^END>

Example of use
10 OUTPUT 717;":CONT:HAND:OUTP1 1"
20 OUTPUT 717;":CONT:HAND:OUTP1?"
30 ENTER 717;A

Equivalent key No equivalent key is available on the front panel.

:CONT:HAND:RTR:STAT

Syntax :CONTrOl:HANDler[:EXTension]:RTRigger:STATe {ON|OFF|1|0}
:CONTrOl:HANDler[:EXTension]:RTRigger:STATe?

Description Turns ON/OFF outputting the READY FOR TRIGGER signal to B7 of the handler I/O.
For details about the handler I/O, see Chapter 10.

Parameters

	Description
ON or 1	Turns ON the READY FOR TRIGGER signal output.
OFF or 0 (preset value)	Turns OFF the READY FOR TRIGGER signal output.

Query response {1|0}<newline><^END>

Example of use
10 OUTPUT 717;":CONT:HAND:RTR:STAT ON"
20 OUTPUT 717;":CONT:HAND:RTR:STAT?"
30 ENTER 717;A

Related commands :CONT:HAND:IND:STAT on page 300

Equivalent key No equivalent key is available on the front panel.

:DISP:ANN:FREQ

Syntax :DISPlay:ANNotation:FREQuency[:STATe] {ON|OFF|1|0}
:DISPlay:ANNotation:FREQuency[:STATe]?

Description Turns ON/OFF the frequency display on the LCD display.

Parameters

	Description
ON or 1 (preset value)	Turns ON the frequency display.
OFF or 0	Turns OFF the frequency display.

Query response {1|0}<newline><^END>

Example of use
10 OUTPUT 717;":DISP:ANN:FREQ OFF"
20 OUTPUT 717;":DISP:ANN:FREQ?"
30 ENTER 717;A

Equivalent key **[Display] - Frequency**

:DISP:CCL

Syntax :DISPlay:CCLear

Description Clears the error message display on the instrument status bar (at the bottom of the LCD display). (No query)

Example of use 10 OUTPUT 717;":DISP:CCL"

Equivalent key All front panel keys.

:DISP:CLOC

Syntax :DISPlay:CLOCK {ON|OFF|1|0}
 :DISPlay:CLOCK?

Description Turns ON/OFF the clock display at the right edge of the instrument status bar (at the bottom of the LCD display).

Parameters

	Description
ON or 1 (preset value)	Turns ON the clock display.
OFF or 0	Turns OFF the clock display.

Query response {1|0}<newline><^END>

Example of use

```
10  OUTPUT 717;":DISP:CLOC OFF"
20  OUTPUT 717;":DISP:CLOC?"
30  ENTER 717;A
```

Equivalent key **[System] - Misc Setup - Clock Setup - Show Clock**

:DISP:COL{1-2}:BACK

Syntax :DISPlay:COLor{[1]2}:BACK <numeric 1>,<numeric 2>,<numeric 3>
 :DISPlay:COLor{[1]2}:BACK?

Description Sets the background color for normal display (:COL1) and inverted display (:COL2).

Parameters

	<numeric 1>	<numeric 2>	<numeric 3>
Description	Amount of red	Amount of green	Amount of blue
Range	0 to 5	0 to 5	0 to 5
Resolution	1	1	1

If the specified parameter is out of the allowable setup range, the minimum value (if the lower limit of the range is not reached) or the maximum value (if the upper limit of the range is exceeded) is set.

Query response {numeric 1},{numeric 2},{numeric 3}<newline><^END>

Example of use
 10 OUTPUT 717;":DISP:COL:BACK 1,2,3"
 20 OUTPUT 717;":DISP:COL:BACK?"
 30 ENTER 717;A,B,C

Related commands :DISP:COL{1-2}:RES on page 306

Equivalent key **[System] - Misc Setup - Color Setup - Normal|Invert - Background**

:DISP:COL{1-2}:GRAT{1-2}

Syntax :DISPlay:COLor{[1]2}:GRATicule{[1]2} <numeric 1>,<numeric 2>,<numeric 3>
:DISPlay:COLor{[1]2}:GRATicule{[1]2}?

Description Sets the color of the graticule label and the outer frame line of the graph (:GRAT1) and the color of the grid line of the graph (:GRAT2) for normal display (:COL1) and inverted display (:COL2).

Parameters

	<numeric 1>	<numeric 2>	<numeric 3>
Description	Amount of red	Amount of green	Amount of blue
Range	0 to 5	0 to 5	0 to 5
Resolution	1	1	1

If the specified parameter is out of the allowable setup range, the minimum value (if the lower limit of the range is not reached) or the maximum value (if the upper limit of the range is exceeded) is set.

Query response {numeric 1},{numeric 2},{numeric 3}<newline><^END>

Example of use
10 OUTPUT 717;":DISP:COL1:GRAT1 1,2,3"
20 OUTPUT 717;":DISP:COL1:GRAT1?"
30 ENTER 717;A,B,C

Related commands :DISP:COL{1-2}:RES on page 306

Equivalent key [System] - Misc Setup - Color Setup - Normal|Invert - Graticule Main|Graticule Sub

:DISP:COL{1-2}:LIM{1-2}

Syntax :DISPlay:COLor{[1]|2}:LIMit{[1]|2} <numeric 1>,<numeric 2>,<numeric 3>
:DISPlay:COLor{[1]|2}:LIMit{[1]|2}?

Description Sets the fail display color used for the limit test result (:LIM1) and the color of the limit line (:LIM2) for normal display (:COL1) and inverted display (:COL2).

Parameters

	<numeric 1>	<numeric 2>	<numeric 3>
Description	Amount of red	Amount of green	Amount of blue
Range	0 to 5	0 to 5	0 to 5
Resolution	1	1	1

If the specified parameter is out of the allowable setup range, the minimum value (if the lower limit of the range is not reached) or the maximum value (if the upper limit of the range is exceeded) is set.

Query response {numeric 1},{numeric 2},{numeric 3}<newline><^END>

Example of use
10 OUTPUT 717;":DISP:COL1:LIM1 1,2,3"
20 OUTPUT 717;":DISP:COL1:LIM1?"
30 ENTER 717;A,B,C

Related commands :DISP:COL{1-2}:RES on page 306

Equivalent key **[System] - Misc Setup - Color Setup - Normal|Invert - Limit Fail|Limit Line**

:DISP:COL{1-2}:RES

Syntax :DISPlay:COLor{[1]|2}:RESet

Description Resets the display color settings for all the items to the factory preset state for normal display (:COL1) and inverted display (:COL2). (No query)

Example of use 10 OUTPUT 717;":DISP:COL1:RES"

Related commands :DISP:COL{1-2}:BACK on page 304
:DISP:COL{1-2}:GRAT{1-2} on page 305
:DISP:COL{1-2}:LIM{1-2} on page 306
:DISP:COL{1-2}:BACK on page 304
:DISP:COL{1-2}:BACK on page 304

Equivalent key **[System] - Misc Setup - Color Setup - Normal|Invert - Reset Color - OK**

:DISP:COL{1-2}:TRAC{1-4}:DATA

Syntax :DISPlay:COLor{[1]2}:TRAC{[1]2|3|4}:DATA <numeric 1>,<numeric 2>,<numeric 3>
:DISPlay:COLor{[1]2}:TRAC{[1]2|3|4}:DATA?

Description Sets the color of the data trace of trace 1 (:TRAC1) to trace 4 (:TRAC4) for normal display (:COL1) and inverted display (:COL2).

Parameters

	<numeric 1>	<numeric 2>	<numeric 3>
Description	Amount of red	Amount of green	Amount of blue
Range	0 to 5	0 to 5	0 to 5
Resolution	1	1	1

If the specified parameter is out of the allowable setup range, the minimum value (if the lower limit of the range is not reached) or the maximum value (if the upper limit of the range is exceeded) is set.

Query response {numeric 1},{numeric 2},{numeric 3}<newline><^END>

Example of use
10 OUTPUT 717;":DISP:COL1:TRAC1:DATA 1,2,3"
20 OUTPUT 717;":DISP:COL1:TRAC1:DATA?"
30 ENTER 717;A,B,C

Related commands :DISP:COL{1-2}:RES on page 306

Equivalent key [System] - Misc Setup - Color Setup - Normal|Invert - Data Trace 1|Data Trace 2|Data Trace 3|Data Trace 4

:DISP:COL{1-2}:TRAC{1-4}:MEM

Syntax :DISPlay:COLor{[1]|2}:TRAC{[1]|2|3|4}:MEMory <numeric 1>,<numeric 2>,<numeric 3>

:DISPlay:COLor{[1]|2}:TRAC{[1]|2|3|4}:MEMory?

Description Sets the color of the memory trace of trace 1 (:TRAC1) to trace 4 (:TRAC4) for normal display (:COL1) and inverted display (:COL2).

Parameters

	<numeric 1>	<numeric 2>	<numeric 3>
Description	Amount of red	Amount of green	Amount of blue
Range	0 to 5	0 to 5	0 to 5
Resolution	1	1	1

If the specified parameter is out of the allowable setup range, the minimum value (if the lower limit of the range is not reached) or the maximum value (if the upper limit of the range is exceeded) is set.

Query response {numeric 1},{numeric 2},{numeric 3}<newline><^END>

Example of use
 10 OUTPUT 717;":DISP:COL1:TRAC1:MEM 1,2,3"
 20 OUTPUT 717;":DISP:COL1:TRAC1:MEM?"
 30 ENTER 717;A,B,C

Related commands :DISP:COL{1-2}:RES on page 306

Equivalent key **[System] - Misc Setup - Color Setup - Normal|Invert - Mem Trace 1|Mem Trace 2|Mem Trace 3|Mem Trace 4**

:DISP:ECHO

- Syntax :DISPlay:ECHO[:DATA] <string>
- Description Displays a character string in the echo window. (No query)
- Parameters

	<string>
Description	Character string you want to display
Range	254 characters or less

- Example of use 10 OUTPUT 717;":DISP:ECHO ""TEST RESULT""
- Related commands :DISP:ECHO:CLE on page 309
:DISP:TABL on page 314
:DISP:TABL:TYPE on page 315
- Equivalent key No equivalent key is available on the front panel.

:DISP:ECHO:CLE

- Syntax :DISPlay:ECHO:CLEar
- Description Clears all character strings displayed in the echo window. (No query)
- Example of use 10 OUTPUT 717;":DISP:ECHO:CLE"
- Related commands :DISP:ECHO on page 309
- Equivalent key **[Macro Setup] - Clear Echo**

:DISP:ENAB

Syntax :DISPlay:ENABle {ON|OFF|1|0}
:DISPlay:ENABle?

Description Turns ON/OFF the update of the LCD display.
When the update of the LCD display is OFF, You can update the LCD display once using :DISP:UPD command.

Parameters

	Description
ON or 1 (preset value)	Turns ON the update.
OFF or 0	Turns OFF the update.

Query response {1|0}<newline><^END>

Example of use
10 OUTPUT 717;":DISP:ENAB OFF"
20 OUTPUT 717;":DISP:ENAB?"
30 ENTER 717;A

Related commands :DISP:UPD on page 316

Equivalent key **[Display] - Update**

:DISP:FSIG

Syntax :DISPlay:FSIGn {ON|OFF|1|0}
:DISPlay:FSIGn?

Description Turns on or off the Fail display when the limit test fails.

Parameters

	Description
ON or 1 (preset value)	Turns on the Fail display.
OFF or 0	Turns off the Fail display.

Query response {1|0}<newline><^END>

Example of use
10 OUTPUT 717;":DISP:FSIG OFF"
20 OUTPUT 717;":DISP:FSIG?"
30 ENTER 717;A

Related commands :CALC{1-4};LIM on page 230

Equivalent key **[Analysis] - Limit Test - Fail Sign**

:DISP:IMAG

Syntax :DISPlay:IMAGe {NORMal|INVert}
:DISPlay:IMAGe?

Description Selects the display type of the LCD display.

Parameters

	Description
NORMal (preset value)	Specifies the normal display (background color: black).
INVert	Specifies the display in which the color of the normal display is inverted (background color: white).

Query response {NORM|INV}<newline><^END>

Example of use
10 OUTPUT 717;":DISP:IMAG INV"
20 OUTPUT 717;":DISP:IMAG?"
30 ENTER 717;A\$

Equivalent key **[Display] - Invert Color**

:DISP:MAX

Syntax :DISPlay:MAXimize {ON|OFF|1|0}
:DISPlay:MAXimize?

Description Turns ON/OFF the window maximization of the active channel (specified with the :DISP:WIND{1-4}:ACT command).
If you turned ON the maximization, only the window of the active channel is maximized on the LCD display and the windows of the other channels are not displayed.

Parameters

	Description
ON or 1	Turns ON the maximization.
OFF or 0 (preset value)	Turns OFF the maximization.

Query response {1|0}<newline><^END>

Example of use
10 OUTPUT 717;":DISP:MAX ON"
20 OUTPUT 717;":DISP:MAX?"
30 ENTER 717;A

Related commands :DISP:WIND{1-4}:ACT on page 316

Equivalent key **[Channel Max]**

:DISP:SKEY

Syntax :DISPlay:SKEY[:STATe] {ON|OFF|1|0}
:DISPlay:SKEY[:STATe]?

Description Turns ON/OFF the display of the softkey labels.

Parameters

	Description
ON or 1 (preset value)	Specifies ON.
OFF or 0	Specifies OFF.

Query response {1|0}<newline><^END>

Example of use
10 OUTPUT 717;":DISP:MAX ON"
20 OUTPUT 717;":DISP:MAX?"
30 ENTER 717;A

Equivalent key **[Entry Off] ([Softkey On/Off])**

:DISP:SPL

Syntax :DISPlay:SPLit {D1|D12|D1_2|D112|D1_1_2|D123|D1_2_3|D12_33|D11_23|D13_23|D12_13|D1234|D1_2_3_4|D12_34}
:DISPlay:SPLit?

Description Sets the layout of the windows on the LCD display. For details about the window layout, refer to Figure 3-1 on page 43.

Parameters

	Description
D1 (preset value)	Specifies the layout in which the window for channel 1 only is displayed on the entire display.
D12	Specifies the layout in which the window for channel 1 is displayed on the left side of the display area and the window for channel 2 on the right side.
D1_2	Specifies the layout in which the window for channel 1 is displayed in the upper part and the window for channel 2 in the lower part.
D112	Specifies the layout in which the window for channel 1 is displayed on the left side of 2/3 and the window for channel 2 on the right side of 1/3.
D1_1_2	Specifies the layout in which the window for channel 1 is displayed in the upper part of 2/3 and the window for channel 2 in the lower part of 1/3.
D123	Specifies the layout in which the windows for channel 1, 2, and 3 are displayed in the left side, middle part, and right side, respectively.
D1_2_3	Specifies the layout in which the windows for channel 1, 2, and 3 are displayed in the upper part, middle part, and the lower part, respectively.
D12_33	Specifies the layout in which the windows for channel 1, 2, and 3 are displayed in the upper left, upper right, and lower part, respectively.
D11_23	Specifies the layout in which the windows for channel 1, 2, and 3 are displayed in the upper part, lower left, and lower right, respectively.
D13_23	Specifies the layout in which the windows for channel 1, 2, and 3 are displayed in the upper left, lower left, and right side, respectively.
D12_13	Specifies the layout in which the windows for channel 1, 2, and 3 are displayed in the left side, upper right, and lower right, respectively.
D1234	Specifies the layout in which the windows for channel 1, 2, 3 and 4 are displayed by splitting the screen horizontally into four equal parts.
D1_2_3_4	Specifies the layout in which the windows for channel 1, 2, 3 and 4 are displayed by splitting the screen vertically into four equal parts.
D12_34	Specifies the layout in which the windows for channel 1, 2, 3, and 4 are displayed in the upper left, upper right, lower left, and lower right, respectively.

Query response {D1|D12|D1_2|D112|D1_1_2|D123|D1_2_3|D12_33|D11_23|D13_23|D12_13|D1234|D1_2_3_4|D12_34}<newline><^END>

Example of use
10 OUTPUT 717;":DISP:SPL D1_2"
20 OUTPUT 717;":DISP:SPL?"
30 ENTER 717;A\$

Related commands :DISP:WIND{1-4}:SPL on page 321

Equivalent key [Display] - Allocate Channels

:DISP:TABL

Syntax :DISPlay:TABLE[:STATe] {ON|OFF|1|0}
:DISPlay:TABLE[:STATe]?

Description Turns ON/OFF the display of the window selected with the :DISP:TABL:TYPE command.

Parameters

	Description
ON or 1	Turns ON the display.
OFF or 0 (preset value)	Turns OFF the display.

Query response {1|0}<newline><^END>

Example of use
10 OUTPUT 717;":DISP:TABL ON"
20 OUTPUT 717;":DISP:TABL?"
30 ENTER 717;A

Related commands :DISP:TABL:TYPE on page 315

Equivalent key **[Sweep Setup] - Edit Segment Table**
[Marker] - Marker Table
[Analysis] - Limit Test - Edit Limit Line
[Macro Setup] - Echo Window

NOTE When performing the operation from the front panel, you select the window and turn ON/OFF the display at the same time.

:DISP:TABL:TYPE

Syntax :DISPlay:TABLE:TYPE {MARKer|LIMit|SEGMENT|ECHO}
:DISPlay:TABLE:TYPE?

Description Selects the window whose display is turned ON/OFF with the :DISP:TABL command.

Parameters

	Description
MARKer (preset value)	Specifies the marker table window.
LIMit	Specifies the limit test table window.
SEGMENT	Specifies the segment table window.
ECHO	Specifies the echo window.

Query response {MARK|LIM|SEGM|ECHO}<newline><<^END>

Example of use
10 OUTPUT 717;":DISP:TABL:TYPE SEGM"
20 OUTPUT 717;":DISP:TABL:TYPE?"
30 ENTER 717;A\$

Related commands :DISP:TABL on page 314

Equivalent key
[Sweep Setup] - Edit Segment Table
[Marker] - Marker Table
[Analysis] - Limit Test - Edit Limit Line
[Macro Setup] - Echo Window

NOTE When performing the operation from the front panel, you select the window and turn ON/OFF the display at the same time.

:DISP:UPD

Syntax	:DISPlay:UPDate[:IMMediate]
Description	Updates the LCD display once when the update of the LCD display is OFF (OFF is specified with the :DISP:ENAB command). (No query)
Example of use	10 OUTPUT 717;":DISP:UPD"
Related commands	:DISP:ENAB on page 310
Equivalent key	No equivalent key is available on the front panel.

:DISP:WIND{1-4}:ACT

Syntax	:DISPlay:WINDow{[1] 2 3 4}:ACTivate
Description	Sets one of channel 1 (:WIND1) to channel 4 (:WIND4) to the active channel. You can set only the displayed channel to the active channel. If you execute this command trying to set a not displayed channel to the active channel, an error occurs and the command is ignored. (No query)
Example of use	10 OUTPUT 717;":DISP:WIND1:ACT"
Related commands	:CALC{1-4}:PAR{1-4}:SEL on page 284
Equivalent key	[Channel Prev] / [Channel Next]

:DISP:WIND{1-4}:ANN:MARK:ALIG

Syntax :DISPlay:WINDow{[1]2|3|4}:ANNotation:MARKer:ALIGn[:STATe] {ON|OFF|1|0}
:DISPlay:WINDow{[1]2|3|4}:ANNotation:MARKer:ALIGn[:STATe]?

Description For channel 1 (:WIND1) to channel 4 (:WIND4), turns ON/OFF the alignment mode in which the display positions of the marker values for each trace are aligned relative to trace 1.

Parameters

	Description
ON or 1 (preset value)	Turns ON the alignment mode using trace 1 as the reference.
OFF or 0	Turn OFF the alignment mode.

Query response {1|0}<newline><^END>

Example of use

```
10  OUTPUT 717;":DISP:WIND1:ANN:MARK:ALIG OFF"
20  OUTPUT 717;":DISP:WIND1:ANN:MARK:ALIG?"
30  ENTER 717;A
```

Equivalent key **[Marker Fctn] - Annotation Options - Align**

:DISP:WIND{1-4}:ANN:MARK:SING

Syntax :DISPlay:WINDow{[1][2][3][4]:ANNotation:MARKer:SINGle[:STATe] {ON|OFF|1|0}
:DISPlay:WINDow{[1][2][3][4]:ANNotation:MARKer:SINGle[:STATe]?

Description For channel 1 (:WIND1) to channel 4 (:WIND4), turns ON/OFF the active trace marker value display.

When set to OFF, the marker values of all displayed traces (markers) are displayed.

Parameters

	Description
ON or 1 (preset value)	Displays the marker value of the active trace only (ON).
OFF or 0	Displays the marker values of all traces (OFF).

Query response {1|0}<newline><^END>

Example of use
10 OUTPUT 717;":DISP:WIND1:ANN:MARK:SING OFF"
20 OUTPUT 717;":DISP:WIND1:ANN:MARK:SING?"
30 ENTER 717;A

Equivalent key **[Marker Fctn] - Annotation Options - Active Only**

:DISP:WIND{1-4}:LAB

Syntax :DISPlay:WINDow{[1]2|3|4}:LABel {ON|OFF|1|0}
:DISPlay:WINDow{[1]2|3|4}:LABel?

Description Turns ON/OFF the display of the graticule label of channel 1 (:WIND1) to channel 4 (:WIND4).

Parameters

	Description
ON or 1 (preset value)	Turns ON the graticule label display.
OFF or 0	Turns OFF the graticule label display.

Query response {1|0}<newline><^END>

Example of use

```
10  OUTPUT 717;":DISP:WIND1:LAB ON"
20  OUTPUT 717;":DISP:WIND1:LAB?"
30  ENTER 717;A
```

Equivalent key **[Display] - Graticule Label**

:DISP:WIND{1-4}:MAX

Syntax :DISPlay:WINDow{[1]|2|3|4}:MAXimize {ON|OFF}|1|0}
:DISPlay:WINDow{[1]|2|3|4}:MAXimize?

Description Turns ON/OFF the maximization of the active trace of channel 1 (:WIND1) to channel 4 (:WIND4) (specified with the :CALC{1-4}:PAR{1-4}:SEL command).
If you turned ON the maximization, only the maximized active trace is displayed in the window and the other traces are not displayed.

Parameters

	Description
ON or 1	Turns ON the maximization.
OFF or 0 (preset value)	Turns OFF the maximization.

Query response {1|0}<newline><^END>

Example of use
10 OUTPUT 717;":DISP:WIND1:MAX ON"
20 OUTPUT 717;":DISP:WIND1:MAX?"
30 ENTER 717;A

Related commands :CALC{1-4}:PAR{1-4}:SEL on page 284
:DISP:MAX on page 312

Equivalent key **[Trace Max]**

:DISP:WIND{1-4}:SPL

Syntax :DISPlay:WINDow{[1]2|3|4}:SPLit {D1|D12|D1_2|D112|D1_1_2|D123|D1_2_3|D12_33|D11_23|D13_23|D12_13|D1234|D1_2_3_4|D12_34}
:DISPlay:WINDow{[1]2|3|4}:SPLit?

Description Sets the graph layout of channel 1 (:WIND1) to channel 4 (:WIND4). For details about the graph layout, refer to Figure 3-1 on page 43.

Parameters

	Description
D1 (preset value)	Specifies the layout in which one graph is displayed in the entire window.
D12	Specifies the layout in which 2 graphs in total are displayed on the left side and right side of the window.
D1_2	Specifies the layout in which 2 graphs in total are displayed in the upper part and lower part of the window.
D112	Specifies the layout in which 2 graphs in total are displayed on the left side of 2/3 and right side of 1/3 of the window.
D1_1_2	Specifies the layout in which 2 graphs in total are displayed in the upper part of 2/3 and lower part of 1/3 of the window.
D123	Specifies the layout in which 3 graphs in total are displayed on the left side, middle part, and right side of the window.
D1_2_3	Specifies the layout in which 3 graphs in total are displayed in the upper part, middle part, and lower part of the window.
D12_33	Specifies the layout in which 3 graphs in total are displayed in the upper left, upper right, and lower part of the window.
D11_23	Specifies the layout in which 3 graphs in total are displayed in the upper part, lower left, and lower right of the window.
D13_23	Specifies the layout in which 3 graphs in total are displayed in the upper left, lower left, and right side of the window.
D12_13	Specifies the layout in which 3 graphs in total are displayed in the left side, upper right, and lower right of the window.
D1234	Specifies the layout in which 4 graphs in total are displayed by splitting the window horizontally into four equal parts.
D1_2_3_4	Specifies the layout in which 4 graphs in total are displayed by splitting the window vertically into four equal parts.
D12_34	Specifies the layout in which 4 graphs in total are displayed in the upper left, upper right, lower left, and lower right of the window.

Query response {D1|D12|D1_2|D112|D1_1_2|D123|D1_2_3|D12_33|D11_23|D13_23|D12_13|D1234|D1_2_3_4|D12_34}<newline><^END>

Example of use

```
10 OUTPUT 717;":DISP:WIND:SPL D1_2"
20 OUTPUT 717;":DISP:WIND:SPL?"
30 ENTER 717;A$
```

Related commands :DISP:SPL on page 313

Equivalent key [Display] - Allocate Traces

:DISP:WIND{1-4}:TITL

Syntax :DISPlay:WINDow{[1]|2|3|4}:TITLe[:STATe] {ON|OFF|1|0}
:DISPlay:WINDow{[1]|2|3|4}:TITLe[:STATe]?

Description Turns ON/OFF the display of the title label of channel 1 (:WIND1) to channel 4 (:WIND4) in the title area.

Parameters

	Description
ON or 1	Turns ON the title label display.
OFF or 0 (preset value)	Turns OFF the title label display.

Query response 10 OUTPUT 717;":DISP:WIND1:TITL ON"
20 OUTPUT 717;":DISP:WIND1:TITL?"
30 ENTER 717;A

Related commands :DISP:WIND{1-4}:TITL:DATA on page 322

Equivalent key **[Display] - Title Label**

:DISP:WIND{1-4}:TITL:DATA

Syntax :DISPlay:WINDow{[1]|2|3|4}:TITLe:DATA <string>
:DISPlay:WINDow{[1]|2|3|4}:TITLe:DATA?

Description Sets the title label displayed in the title area of channel 1 (:WIND1) to channel 4 (:WIND4).

Parameters

	<string>
Description	Title label
Range	254 characters or less
Preset value	""

Query response {string}<newline><^END>

Example of use 10 OUTPUT 717;":DISP:WIND1:TITL:DATA "Title"
20 OUTPUT 717;":DISP:WIND1:TITL?"
30 ENTER 717;A\$

Related commands :DISP:WIND{1-4}:TITL on page 322

Equivalent key **[Display] - Edit Title Label**

:DISP:WIND{1-4}:TRAC{1-4}:ANN:MARK:POS:X

Syntax :DISPlay:WINDow{[1]|2|3|4}:TRACe{[1]|2|3|4}:ANNotation:MARKer:POSition:X
<value>

:DISPlay:WINDow{[1]|2|3|4}:TRACe{[1]|2|3|4}:ANNotationMARKer:POSition:X?

Description For trace 1 (:TRAC1) through trace 4 (:TRAC4) of channel 1 (:WIND1) to channel 4 (:WIND4), sets the X-axis position where the marker value is displayed as the percentage of the display area width.

Parameters

	<value>
Description	The X-axis position where the marker value is displayed.
Range	-15 to 100
Preset value	1
Unit	% (percent)
Resolution	1

Query response {value}<newline><^END>

Example of use

```
10  OUTPUT 717;":DISP:WIND1:TRAC1:ANN:MARK:POS:X 20"
20  OUTPUT 717;":DISP:WIND1:TRAC1:ANN:MARK:POS:X?"
30  ENTER 717;A
```

Related commands :DISP:WIND{1-4}:TRAC{1-4}:ANN:MARK:POS:Y on page 324

Equivalent key **[Marker Fctn] - Annotation Options - Marker Info X Pos**

:DISP:WIND{1-4}:TRAC{1-4}:ANN:MARK:POS:Y

Syntax :DISPlay:WINDow{[1]|2|3|4}:TRACe{[1]|2|3|4}:ANNotation:MARKer:POSition:Y
<value>

:DISPlay:WINDow{[1]|2|3|4}:TRACe{[1]|2|3|4}:ANNotationMARKer:POSition:Y?

Description For trace 1 (:TRAC1) through trace 4 (:TRAC4) of channel 1 (:WIND1) to channel 4 (:WIND4), sets the Y-axis position where the marker value is displayed as the percentage of the display area height.

Parameters

	<value>
Description	Y-axis position where the marker value is displayed.
Range	-15 to 100
Preset value	1
Unit	% (percent)
Resolution	1

Query response {value}<newline><^END>

Example of use

```

10 OUTPUT 717;":DISP:WIND1:TRAC1:ANN:MARK:POS:Y 40"
20 OUTPUT 717;":DISP:WIND1:TRAC1:ANN:MARK:POS:Y?"
30 ENTER 717;A

```

Related commands :DISP:WIND{1-4}:TRAC{1-4}:ANN:MARK:POS:X on page 323

Equivalent key **[Marker Fctn] - Annotation Options - Marker Info Y Pos**

:DISP:WIND{1-4}:TRAC{1-4}:ANN:YAX:MODE

Syntax	:DISPlay:WINDow{[1] 2 3 4}:TRACe{[1] 2 3 4}:ANNotation:YAXis:MODE {AUTO RELative} :DISPlay:WINDow{[1] 2 3 4}:TRACe{[1] 2 3 4}:ANNotation:YAXis:MODE?						
Description	For trace 1 (:TRAC1) through trace 4 (:TRAC4) of channel 1 (:WIND1) to channel 4 (:WIND4), sets the graticule label display format on the left side of the Y-axis in the rectangular display format.						
Parameters	<table border="1" style="width: 100%; border-collapse: collapse;"> <thead> <tr> <th style="width: 30%;"></th> <th style="text-align: left;">Description</th> </tr> </thead> <tbody> <tr> <td>AUTO (preset value)</td> <td>Specifies the normal display format.</td> </tr> <tr> <td>RELative</td> <td>Specifies the relative display, based on the reference value.</td> </tr> </tbody> </table>		Description	AUTO (preset value)	Specifies the normal display format.	RELative	Specifies the relative display, based on the reference value.
	Description						
AUTO (preset value)	Specifies the normal display format.						
RELative	Specifies the relative display, based on the reference value.						
Query response	{value}<newline><^END>						
Example of use	<pre>10 OUTPUT 717;" :DISP:WIND1:TRAC1:ANN:YAX:MODE REL" 20 OUTPUT 717;" :DISP:WIND1:TRAC1:ANN:YAX:MODE?" 30 ENTER 717;A</pre>						
Related commands	:DISP:WIND{1-4}:Y:DIV on page 334 :DISP:WIND{1-4}:TRAC{1-4}:Y:RLEV on page 329 :DISP:WIND{1-4}:TRAC{1-4}:Y:RPOS on page 330						
Equivalent key	[Display] - Graticule Label						

:DISP:WIND{1-4}:TRAC{1-4}:MEM

Syntax :DISPlay:WINDow{[1]|2|3|4}:TRACe{[1]|2|3|4} :MEMory[:STATe] {ON|OFF|1|0}
:DISPlay:WINDow{[1]|2|3|4}:TRACe{[1]|2|3|4} :MEMory[:STATe]?

Description For trace 1 (:TRAC1) to trace 4 (:TRAC4) of channel 1 (:WIND1) to channel 4 (:WIND4), turns ON/OFF the display of the memory trace.

Parameters

	Description
ON or 1	Turns ON the memory trace display.
OFF or 0 (preset value)	Turns OFF the memory trace display.

Query response {1|0}<newline><^END>

Example of use
10 OUTPUT 717;":DISP:WIND1:TRAC1:MEM ON"
20 OUTPUT 717;":DISP:WIND1:TRAC1:MEM?"
30 ENTER 717;A

Related commands :DISP:WIND{1-4}:TRAC{1-4}:STAT on page 327
:CALC{1-4}:MATH:MEM on page 279

Equivalent key **[Display] - Display - Mem** (when the data trace display is OFF)
[Display] - Display - Data & Mem (when the data trace display is ON)

:DISP:WIND{1-4}:TRAC{1-4}:STAT

Syntax :DISPlay:WINDow{[1]|2|3|4}:TRACe{[1]|2|3|4} :STATe {ON|OFF|1|0}
:DISPlay:WINDow{[1]|2|3|4}:TRACe{[1]|2|3|4} :STATe?

Description For trace 1 (:TRAC1) to trace 4 (:TRAC4) of channel 1 (:WIND1) to channel 4 (:WIND4), turns ON/OFF the display of the data trace.

Parameters

	Description
ON or 1 (preset value)	Turns ON the data trace display.
OFF or 0	Turns OFF the data trace display.

Query response {1|0}<newline><^END>

Example of use
10 OUTPUT 717;":DISP:WIND1:TRAC1:STAT ON"
20 OUTPUT 717;":DISP:WIND1:TRAC1:STAT?"
30 ENTER 717;A

Related commands :DISP:WIND{1-4}:TRAC{1-4}:MEM on page 326

Equivalent key **[Display] - Display - Data** (when the memory trace display is OFF)
[Display] - Display - Data & Mem (when the memory trace display is ON)

:DISP:WIND{1-4}:TRAC{1-4}:Y:AUTO

Syntax :DISPlay:WINDow{[1]|2|3|4}:TRACe{[1]|2|3|4} :Y[:SCALE]:AUTO

Description For trace 1 (:TRAC1) to trace 4 (:TRAC4) of channel 1 (:WIND1) to channel 4 (:WIND4), executes the auto scale (function to automatically adjust the value of the reference graticule line and the scale per division to display the trace appropriately). (No query)

Example of use 10 OUTPUT 717;":DISP:WIND1:TRAC1:Y:AUTO"

Related commands :DISP:WIND{1-4}:TRAC{1-4}:Y:PDIV on page 328
:DISP:WIND{1-4}:TRAC{1-4}:Y:RLEV on page 329

Equivalent key **[Scale] - Auto Scale**

:DISP:WIND{1-4}:TRAC{1-4}:Y:PDIV

Syntax :DISPlay:WINDow{[1]|2|3|4}:TRACe{[1]|2|3|4} :Y[:SCALe]:PDIVision <numeric>
:DISPlay:WINDow{[1]|2|3|4}:TRACe{[1]|2|3|4} :Y[:SCALe]:PDIVision?

Description For trace 1 (:TRAC1) to trace 4 (:TRAC4) of channel 1 (:WIND1) to channel 4 (:WIND4): when the data format is not the Smith chart format or the polar format, sets the scale per division; when the data format is the Smith chart format or the polar format, sets the full scale value (the value of the outermost circle).

Parameters

	<numeric>
Description	Scale value
Range	1E-18 to 1E8
Preset value	Varies depending on the data format as follows: Logarithmic Magnitude: 10 Phase, Expand Phase, Positive Phase: 90 Group Delay: 1E-8 Smith, Polar, SWR: 1 Linear Magnitude: 0.1 Real, Imaginary: 0.2
Unit	Varies depending on the data format as follows: Logarithmic Magnitude: dB (decibel) Phase, Expand Phase, Positive Phase: ° (degree) Group Delay: s (second) Others: No unit

If the specified parameter is out of the allowable setup range, the minimum value (if the lower limit of the range is not reached) or the maximum value (if the upper limit of the range is exceeded) is set.

Query response {numeric}<newline><^END>

Example of use
10 OUTPUT 717; ":DISP:WIND1:TRAC1:Y:PDIV 2.5"
20 OUTPUT 717; ":DISP:WIND1:TRAC1:Y:PDIV?"
30 ENTER 717;A

Related commands :DISP:WIND{1-4}:Y:DIV on page 334
:DISP:WIND{1-4}:TRAC{1-4}:Y:RLEV on page 329
:DISP:WIND{1-4}:TRAC{1-4}:Y:RPOS on page 330

Equivalent key [Scale] - Scale/Div

:DISP:WIND{1-4}:TRAC{1-4}:Y:RLEV

Syntax :DISPlay:WINDow{[1]|2|3|4}:TRACe{[1]|2|3|4} :Y[:SCALE]:RLEVel <numeric>
:DISPlay:WINDow{[1]|2|3|4}:TRACe{[1]|2|3|4} :Y[:SCALE]:RLEVel?

Description For trace 1 (:TRAC1) to trace 4 (:TRAC4) of channel 1 (:WIND1) to channel 4 (:WIND4), sets the value of the reference graticule line.

Parameters

	<numeric>
Description	Value of reference graticule line
Range	-5E8 to 5E8
Preset value	0*1
Unit	Varies depending on the data format as follows: Logarithmic Magnitude: dB (decibel) Phase, Expand Phase, Positive Phase: ° (degree) Group Delay: s (second) Others: No unit

*1. When the data format is "SWR," the preset value is 1.

If the specified parameter is out of the allowable setup range, the minimum value (if the lower limit of the range is not reached) or the maximum value (if the upper limit of the range is exceeded) is set.

Query response {numeric}<newline><^END>

Example of use
10 OUTPUT 717;":DISP:WIND1:TRAC1:Y:RLEV 1E2"
20 OUTPUT 717;":DISP:WIND1:TRAC1:Y:RLEV?"
30 ENTER 717;A

Related commands :DISP:WIND{1-4}:Y:DIV on page 334
:DISP:WIND{1-4}:TRAC{1-4}:Y:PDIV on page 328
:DISP:WIND{1-4}:TRAC{1-4}:Y:RPOS on page 330

Equivalent key **[Scale] - Reference Value**

:DISP:WIND{1-4}:TRAC{1-4}:Y:RPOS

Syntax :DISPlay:WINDow{[1]|2|3|4}:TRACe{[1]|2|3|4} :Y[:SCALe]:RPOSition <numeric>
:DISPlay:WINDow{[1]|2|3|4}:TRACe{[1]|2|3|4} :Y[:SCALe]:RPOSition?

Description For trace 1 (:TRAC1) to trace 4 (:TRAC4) of channel 1 (:WIND1) to channel 4 (:WIND4), specifies a reference graticule line with its number (an integer assigned starting from 0 from the lowest division).

Parameters

	<numeric>
Description	Number of graticule line
Range	0 to the number of divisions*1
Preset value	5*2
Resolution	1

*1. Set with the :DISP:WIND{1-4}:Y:DIV commands.

*2. When the data format is "Linear Magnitude" or "SWR," the preset value is 1.

If the specified parameter is out of the allowable setup range, the minimum value (if the lower limit of the range is not reached) or the maximum value (if the upper limit of the range is exceeded) is set.

Query response {numeric}<newline><^END>

Example of use
10 OUTPUT 717; ":DISP:WIND1:TRAC1:Y:RPOS 6"
20 OUTPUT 717; ":DISP:WIND1:TRAC1:Y:RPOS?"
30 ENTER 717;A

Related commands :DISP:WIND{1-4}:Y:DIV on page 334
:DISP:WIND{1-4}:TRAC{1-4}:Y:PDIV on page 328
:DISP:WIND{1-4}:TRAC{1-4}:Y:RLEV on page 329

Equivalent key [Scale] - Reference Position

:DISP:WIND{1-4}:TRAC{1-4}:Y:TRAC:FREQ

Syntax :DISPlay:WINDow{[1]|2|3|4}:TRACe{[1]|2|3|4}:Y:TRACk:FREQuency <value>
:DISPlay:WINDow{[1]|2|3|4}:TRACe{[1]|2|3|4}:Y:TRACk:FREQuency?

Description For trace 1 (:TRAC1) through trace 4 (:TRAC4) of channel 1 (:WIND1) to channel 4 (:WIND4), sets a frequency when you want to specify a frequency on trace data as the reference value. Tracking is not performed when the specified frequency lies outside the preset range. When a frequency that does not match any measurement point is specified, interpolation is performed using the preceding and following measurement points, and the resulting value is used as the reference value for tracking.

Parameters

	<value>
Description	Frequency for tracking
Range	-1E12 to 1E12
Preset value	0
Unit	Hz (hertz), dBm, or s (seconds)

Query response {value}<newline><^END>

Example of use 10 OUTPUT 717;":DISP:WIND1:TRAC1:Y:TRAC:FREQ 1E9"
20 OUTPUT 717;":DISP:WIND1:TRAC1:Y:TRAC:FREQ?"
30 ENTER 717;A

Related commands :DISP:WIND{1-4}:Y:DIV on page 334
:DISP:WIND{1-4}:TRAC{1-4}:Y:TRAC:MODE on page 332

Equivalent key **[Scale] - Reference Tracking - Track Frequency**

:DISP:WIND{1-4}:TRAC{1-4}:Y:TRAC:MODE

Syntax :DISPlay:WINDow{[1]|2|3|4}:TRACe{[1]|2|3|4}:Y:TRACk:MODE
 {OFF|PEAK|FREQuency}
 :DISPlay:WINDow{[1]|2|3|4}:TRACe{[1]|2|3|4}:Y:TRACk:MODE?

Description For trace 1 (:TRAC1) and trace 4 (:TRAC4) of channel 1 (:WIND1) to channel 4 (:WIND4), sets the tracking method to offset the trace data after sweep.

Parameters

	Description
OFF (preset value)	Does not perform tracking for trace data.
PEAK	Specifies the peak value as the reference value.
FREQuency	Specifies the specified frequency as the reference value.

Query response {OFF|PEAK|FREQ}<newline><^END>

Example of use

```

10  OUTPUT 717;":DISP:WIND1:TRAC1:Y:TRAC:MODE PEAK"
20  OUTPUT 717;":DISP:WIND1:TRAC1:Y:TRAC:MODE?"
30  ENTER 717;A

```

Related commands :DISP:WIND{1-4}:Y:DIV on page 334
 :DISP:WIND{1-4}:TRAC{1-4}:Y:TRAC:FREQ on page 331

Equivalent key **[Scale] - Reference Tracking - Tracking**

:DISP:WIND{1-4}:X:SPAC

Syntax :DISPlay:WINDow{[1]2|3|4}:X:SPACing {LINear|OBASe}
:DISPlay:WINDow{[1]2|3|4}:X:SPACing?

Description Selects the display method of the graph horizontal axis of channel 1 (:WIND1) to channel 4 (:WIND4) for segment sweep.

Parameters

	Description
LINear	Specifies the frequency base (linear frequency axis with the minimum frequency at the left edge and the maximum frequency at the right edge).
OBASe (preset value)	Specifies the order base (axis in which the measurement point numbers are positioned evenly in the order of measurement).

Query response {LIN|OBAS}<newline><^END>

Example of use

```
10  OUTPUT 717;":DISP:WIND1:X:SPAC OBAS"
20  OUTPUT 717;":DISP:WIND1:X:SPAC?"
30  ENTER 717;A$
```

Related commands :SENS{1-4}:SWE:TYPE on page 426

Equivalent key **[Sweep Setup] - Segment Display**

:DISP:WIND{1-4}:Y:DIV

Syntax :DISPlay:WINDow{[1]|2|3|4}:Y[:SCALe]:DIVisions <numeric>
:DISPlay:WINDow{[1]|2|3|4}:Y[:SCALe]:DIVisions?

Description Sets the number of divisions of all the graphs of channel 1 (:WIND1) to channel 4 (:WIND4).
The number of graticule line (specified with the :DISP:WIND{1-4}:TRAC{1-4}:Y:RPOS command) depends on this setting.

Parameters

	<numeric>
Description	Divisions
Range	4 to 30
Preset value	10
Resolution	2

If the specified parameter is out of the allowable setup range, the minimum value (if the lower limit of the range is not reached) or the maximum value (if the upper limit of the range is exceeded) is set.

Query response {numeric}<newline><^END>

Example of use 10 OUTPUT 717;":DISP:WIND1:Y:DIV 12"
20 OUTPUT 717;":DISP:WIND1:Y:DIV?"
30 ENTER 717;A

Related commands :DISP:WIND{1-4}:TRAC{1-4}:Y:PDIV on page 328
:DISP:WIND{1-4}:TRAC{1-4}:Y:RLEV on page 329
:DISP:WIND{1-4}:TRAC{1-4}:Y:RPOS on page 330

Equivalent key **[Scale] - Divisions**

:FORM:BORD

Syntax :FORMat:BORDer {NORMal|SWAPped}
:FORMat:BORDer?

Description When the data transfer format is set to the binary transfer format, sets the transfer order of each byte in data (byte order).
For details about the data transfer format, refer to “Data Transfer Format” on page 102.

Parameters

	Description
NORMal (preset value)	Specifies the byte order in which transfer starts from the byte including MSB (Most Significant Bit).
SWAPped	Specifies the byte order in which transfer starts from the byte including LSB (Least Significant Bit).

Query response {NORM|SWAP}<newline><^END>

Example of use
10 OUTPUT 717;":FORM:BORD SWAP"
20 OUTPUT 717;":FORM:BORD?"
30 ENTER 717;A\$

Related commands :FORM:DATA on page 336

Equivalent key No equivalent key is available on the front panel.

:FORM:DATA

Syntax :FORMat:DATA {ASCii|REAL|REAL32}
:FORMat:DATA?

Description Use the following commands to set the format to transfer data.

- :CALC{1-4}:DATA:FDAT on page 213
- :CALC{1-4}:DATA:FMEM on page 214
- :CALC{1-4}:DATA:SDAT on page 215
- :CALC{1-4}:DATA:SMEM on page 216
- :CALC{1-4}:FUNC:DATA? on page 219
- :CALC{1-4}:LIM:DATA on page 231
- :CALC{1-4}:LIM:REP? on page 240
- :SENS{1-4}:FREQ:DATA? on page 414
- :SENS{1-4}:SEGM:DATA on page 419

For details about the data transfer format, refer to “Data Transfer Format” on page 102.

Parameters

	Description
ASCii (preset value)	Specifies the ASCII transfer format.
REAL	Specifies the IEEE 64-bit floating point binary transfer format.
REAL32	Specifies the IEEE 32-bit floating point binary transfer format.

Query response {ASC|REAL|REAL32}<newline><^END>

Example of use

```
10 OUTPUT 717; ":FORM:DATA REAL"
20 OUTPUT 717; ":FORM:DATA?"
30 ENTER 717;A$
```

Related commands :FORM:BORD on page 335

Equivalent key No equivalent key is available on the front panel.

:HCOP

Syntax	:HCOPy[:IMMediate]
Description	Outputs the display image on the LCD display to the printer connected to the E5061A/E5062A. (No query)
Example of use	10 OUTPUT 717;":HCOP"
Related commands	:HCOP:ABOR on page 337 :HCOP:IMAG on page 337
Equivalent key	[System] - Print

:HCOP:ABOR

Syntax	:HCOPy:ABORt
Description	Aborts the print output. (No query)
Example of use	10 OUTPUT 717;":HCOP:ABOR"
Related commands	:HCOP on page 337
Equivalent key	[System] - Abort Printing

:HCOP:IMAG

Syntax	:HCOPy:IMAGe {NORMal INVert} :HCOPy:IMAGe?
Description	Selects the print color for output to the printer.
Parameters	

	Description
NORMal	Specifies printing in close color to the display color.
INVert (preset value)	Specifies printing in the inverted color of the display color.

Query response	{NORM INV}<newline><^END>
Example of use	10 OUTPUT 717;":HCOP:IMAG NORM" 20 OUTPUT 717;":HCOP:IMAG?" 30 ENTER 717;A\$
Related commands	:HCOP on page 337
Equivalent key	[System] - Invert Image

:INIT{1-4}

Syntax	<code>:INITiate {[1] 2 3 4}[:IMMediate]</code>
Description	<p>Changes the state of each channel of channel 1 (:INIT1) to channel 4 (:INIT4) to the startup state in the trigger system.</p> <p>When this command is executed for a channel in the idle state, it goes into the initiate state immediately. Then, after measurement is executed once, it goes back to the idle state.</p> <p>If this command is executed for a channel that is not in the idle state or for which the continuous initiation mode is set to ON (ON is specified with the <code>:INIT{1-4}:CONT</code> command), an error occurs and the command is ignored.</p> <p>For details about the trigger system, refer to “Trigger system” on page 78. (No query)</p>
Example of use	<code>10 OUTPUT 717;":INIT1"</code>
Related commands	<code>:INIT{1-4}:CONT</code> on page 339
Equivalent key	[Trigger] - Single

:INIT{1-4}:CONT

Syntax :INITiate{[1]|2|3|4}:CONTinuous {ON|OFF|1|0}
:INITiate{[1]|2|3|4}:CONTinuous?

Description Turns ON/OFF of the continuous initiation mode of channel 1 (:INIT1) to channel 4 (:INIT4) in the trigger system.
For details about the trigger system, refer to “Trigger system” on page 78.

Parameters

	Description
ON or 1	Turns ON the continuous initiation mode.
OFF or 0	Turns OFF the continuous initiation mode.

Regarding to this setting, only channel 1 is initialized to ON with the :SYST:PRES command; all the channels are initialized to OFF with the *RST command.

Query response {1|0}<newline><<^END>

Example of use 10 OUTPUT 717;":INIT1:CONT OFF"
20 OUTPUT 717;":INIT1:CONT?"
30 ENTER 717;A

Related commands :INIT{1-4} on page 338

Equivalent key **[Trigger] - Continuous** (continuous initiation mode ON)
[Trigger] - Hold (continuous initiation mode OFF)

:MMEM:CAT?

Syntax :MMEMory:CATalog? <string 1>

Description Reads out the following information on the built-in storage device of the E5061A/E5062A.

To read out the information in the root directory (folder), specify “\” (backslash). If you want to specify a directory on the floppy disk drive, you need to add “A:” at the beginning of the file name. Separate directory names with “/” (slash) or “\” (backslash). (Query only)

- Space in use
- Available space
- Name and size of all files (including directories) in the specified directory.

Parameters

	<string 1>
Description	Directory name whose information you want to read out
Range	254 characters or less

Query response {string 2}<newline><^END>

The format of the readout character string is as follows:

"{used_size},{free_size},{name 1},{size 1},...,{name N},{size N}"

Where N is the number of all files in the specified directory and n is an integer between 1 and N.

{used_size}: Space in use of the built-in storage device (byte)*1.

{free_size}: Available space of the built-in storage device (byte)*1.

{name n}: Name of the n-th file (directory).

{size n}: Size (byte) of the n-th file (directory). Always 0 for directories.

Example of use

```
10 DIM A$(1000)
20 OUTPUT 717;":MMEM:CAT? ""\ ""
30 ENTER 717;A$
```

Equivalent key No equivalent key is available on the front panel.

*1. If you specify a directory on the floppy disk drive, it is the capacity of the floppy disk in the drive.

:MMEM:COPY

Syntax :MMEMory:COPY <string 1>,<string 2>

Description Copies a file.

Specify the file name with the extension. If you want to specify a file on the floppy disk drive, you need to add "A:" at the beginning of the file name. When you use directory (folder) names and file name, separate them with "/" (slash) or "\" (backslash).

If the specified copy source file does not exist, an error occurs and the command is ignored. Notice that, if a file with the same name as the specified copy destination file name exists, its contents are overwritten. (No query)

Parameters

	<string 1>	<string 2>
Description	Copy source file name	Copy destination file name
Range	254 characters or less	254 characters or less

Example of use 10 OUTPUT 717;":MMEM:COPY ""Test1/State01.sta",""A:Test1_01.sta""

Equivalent key Practical front key operation is not available.

:MMEM:DEL

Syntax :MMEMory:DELeTe <string>

Description Deletes an existing file or directory (folder).

When you delete a directory, all the files and directories in it are deleted.

Specify the file name with the extension. If you want to specify a file or directory on the floppy disk drive, you need to add "A:" at the beginning of its name. When you specify a file (directory) under an existing directory, separate them with "/" (slash) or "\" (backslash).

If the specified file or directory does not exist, an error occurs and the command is ignored. (No query)

Parameters

	<string>
Description	File name or directory name you want to delete
Range	254 characters or less

Example of use

```
10 OUTPUT 717;":MMEM:DEL ""Test1/State01.sta""  
10 OUTPUT 717;":MMEM:DEL ""A:State01.sta""
```

Equivalent key Practical front key operation is not available.

:MMEM:LOAD

Syntax :MMEMory:LOAD[:STATe] <string>

Description Recalls the specified instrument state file (file with the .sta extension saved with the :MMEM:STOR command).

Specify the file name with the extension. If you want to specify a file on the floppy disk drive, you need to add "A:" at the beginning of the file name. When you use directory names and file name, separate them with "/" (slash) or "\" (backslash).

If the specified file does not exist, an error occurs and the command is ignored. (No query)

Parameters

	<string>
Description	Instrument state file name
Range	254 characters or less

Example of use

```
10 OUTPUT 717;":MMEM:LOAD ""Test1/State01.sta""
10 OUTPUT 717;":MMEM:LOAD ""A:State01.sta""
```

Related commands :MMEM:STOR on page 351

Equivalent key **[Save/Recall] - Recall State**

:MMEM:LOAD:CHAN

Syntax :MMEMory:LOAD:CHANnel[:STATe] {A|B|C|D}

Description Recalls the instrument state for an individual channel (saved with the :MMEM:STOR:CHAN command) from the specified register as the setting of the active channel (specified with the :DISP:WIND{1-4}:ACT command).

It is possible to recall the register from a different channel where it was saved.

If no instrument state has been saved in the specified register, an error occurs and the command is ignored. (No query)

Parameters

	Description
A	Specifies register A.
B	Specifies register B.
C	Specifies register C.
D	Specifies register D.

Example of use 10 OUTPUT 717;":MMEM:LOAD:CHAN A"

Related commands :MMEM:STOR:CHAN on page 352

:DISP:WIND{1-4}:ACT on page 316

Equivalent key **[Save/Recall] - Recall Channel - A|B|C|D**

:MMEM:LOAD:CHAN:COEF

Syntax :MMEMory:LOAD:CHANnel:COEFficient {A|B|C|D}

Description Recalls the calibration coefficient for an individual channel (saved with the :MMEM:STOR:CHAN:COEF command) from the specified register as the setting of the active channel (specified with the :DISP:WIND{1-4}:ACT command).

It is possible to recall the register from a different channel where it was saved.

If no instrument state has been saved in the specified register, an error occurs and the command is ignored. (No query)

Parameters

	Description
A	Specifies register A.
B	Specifies register B.
C	Specifies register C.
D	Specifies register D.

Example of use 10 OUTPUT 717; ":MMEM:LOAD:CHAN:COEF A"

Related commands

Equivalent key **[Save/Recall] - Recall Channel - Cal Only A|B|C|D**

NOTE The calibration coefficient registers A to D are different from the channel state registers A to D. :MMEM:STOR:CHAN command does not affect the calibration coefficient registers.

:MMEM:LOAD:LIM

Syntax :MMEMory:LOAD:LIMit <string>

Description As the limit table for the active trace (specified with the :CALC{1-4}:PAR{1-4}:SEL command) of the active channel (specified with the :DISP:WIND{1-4}:ACT command), recalls the specified limit table file (file with the .csv extension saved with the :MMEM:STOR:LIM command).

Specify the file name with the extension. If you want to specify a file on the floppy disk drive, you need to add "A:" at the beginning of the file name. When you use directory names and file name, separate them with "/" (slash) or "\" (backslash).

If the specified file does not exist, an error occurs and the command is ignored. (No query)

Parameters

	<string>
Description	File name of limit table
Range	254 characters or less

Example of use
10 OUTPUT 717;":MMEM:LOAD:LIM ""Test1/Limit01.csv""
10 OUTPUT 717;":MMEM:LOAD:LIM ""A:Limit01.csv""

Related commands :MMEM:STOR:LIM on page 356
:DISP:WIND{1-4}:ACT on page 316

Equivalent key **[Analysis] - Limit Test - Edit Limit Line - Import from CSV File**

:MMEM:LOAD:PROG

Syntax :MMEMory:LOAD:PROGram <string>

Description Loads (or imports) a VBA project (a file with the .vba extension), a module (a file with the .bas extension), a user form (a file with the .frm extension) or a class module (a file with the .cls extension).

Specify the file name with the extension. If you want to specify a file on the floppy disk drive, you need to add "A:" at the beginning of the file name. When you use directory names and file name, separate them with "/" (slash) or "\" (backslash).

If the specified file does not exist, an error occurs and the command is ignored. (No query)

Parameters

	<string>
Description	File name
Range	254 characters or less

Example of use

```
10 OUTPUT 717;":MMEM:LOAD:PROG ""Test1/Test1_01.vba""
10 OUTPUT 717;":MMEM:LOAD:PROG ""A:Test1_01.vba""
```

Related commands :MMEM:STOR:PROG on page 357

Equivalent key **[Macro Setup] - Load VBA Project**

:MMEM:LOAD:RLIM

Syntax :MMEMory:LOAD:RLIMit <string>

Description As the ripple limit table for the active trace (specified with the :CALC{1-4}:PAR{1-4}:SEL command) of the active channel (specified with the :DISP:WIND{1-4}:ACT command), recalls the specified ripple limit table file (file with the .csv extension saved with the :MMEM:STOR:RLIM command).

Specify the file name with the extension. If you want to specify a file on the floppy disk drive, you need to add "A:" at the beginning of the file name. When you write directory names and the file name, separate them with a "/" (slash) or "\" (backslash).

If the specified file does not exist, an error occurs and the command is ignored. (No query)

Parameters

	<string>
Description	File name of the ripple limit table.
Range	254 characters or less

Example of use

```
10 OUTPUT 717;":MMEM:LOAD:RLIM ""RTest1/Rlim01.csv""
10 OUTPUT 717;":MMEM:LOAD:RLIM ""A:Rlim01.csv""
```

Related commands :MMEM:STOR:RLIM on page 358
:DISP:WIND{1-4}:ACT on page 316
:CALC{1-4}:PAR{1-4}:SEL on page 284

Equivalent key **[Analysis] - Ripple Limit - Edit Ripple Limit - Import from CSV File**

:MMEM:LOAD:SEGM

Syntax :MMEMory:LOAD:SEGMent <string>

Description As the segment sweep table for the active channel (specified with the :DISP:WIND{1-4}:ACT command), recalls the specified segment sweep table file (a file with the .csv extension saved with the :MMEM:STOR:SEGM command).

Specify the file name with the extension. If you want to specify a file on the floppy disk drive, you need to add "A:" at the beginning of the file name. When you use directory names and file name, separate them with "/" (slash) or "\" (backslash).

If the specified file does not exist, an error occurs and the command is ignored. (No query)

Parameters

	<string>
Description	File name of segment sweep table
Range	254 characters or less

Example of use

```
10 OUTPUT 717;":MMEM:LOAD:SEGM ""Test1/Segm01.csv""
10 OUTPUT 717;":MMEM:LOAD:SEGM ""A:Segm01.csv""
```

Related commands :MMEM:STOR:SEGM on page 360
:DISP:WIND{1-4}:ACT on page 316

Equivalent key **[Sweep Setup] - Edit Segment Table - Import from CSV File**

:MMEM:MDIR

Syntax :MMEMory:MDIRectory <string>

Description Creates a new directory (folder).

If you want to create a directory on the floppy disk drive, you need to add "A:" at the beginning of the directory name. When you create a directory under an existing directory, separate between the directory names with "/" (slash) or "\" (backslash).

If a directory with the same name as the specified directory name exists, an error occurs and the command is ignored. (No query)

Parameters

	<string>
Description	Directory name you want to create
Range	254 characters or less

Example of use

```
10 OUTPUT 717;":MMEM:MDIR ""Test1""  
10 OUTPUT 717;":MMEM:MDIR ""A:Test1""
```

Equivalent key Practical front key operation is not available.

:MMEM:STOR

Syntax :MMEMory:STORe[:STATe] <string>

Description Saves the instrument state (data to be saved specified with the :MMEM:STOR:STYP command) into a file.

Specify the file name with the .sta extension. If you want to specify a file on the floppy disk drive, you need to add "A:" at the beginning of the file name. When you use directory names and file name, separate them with "/" (slash) or "\" (backslash).

Notice that, if a file with the specified file name exists, its contents are overwritten. (No query)

NOTE The instrument setting file saved with the autorec.sta (or A:autorec.sta) file name is automatically recalled when turning on the E5061A/E5062A.

Parameters

	<string>
Description	File name in which you want to save the instrument state
Range	254 characters or less

Example of use

```
10 OUTPUT 717;":MMEM:STOR ""Test1/State01.sta"""
```

```
10 OUTPUT 717;":MMEM:STOR ""A:State01.sta"""
```

Related commands :MMEM:LOAD on page 343
:MMEM:STOR:STYP on page 361

Equivalent key **[Save/Recall] - Save State|Re-Save State**

:MMEM:STOR:CHAN

Syntax :MMEMory:STORe:CHANnel[:STATe] {A|B|C|D}

Description Saves the instrument state of the items set for the active channel (specified with the :DISP:WIND{1-4}:ACT command) specific to that channel only into the specified register (volatile memory).

Notice that, if an instrument state has been saved already in the specified register, its contents are overwritten. (No query)

Parameters

	Description
A	Specifies register A.
B	Specifies register B.
C	Specifies register C.
D	Specifies register D.

Example of use 10 OUTPUT 717; ":MMEM:STOR:CHAN A"

Related commands :MMEM:LOAD:CHAN on page 344
:DISP:WIND{1-4}:ACT on page 316

Equivalent key **[Save/Recall] - Save Channel - A|B|C|D**

:MMEM:STOR:CHAN:CLE

Syntax :MMEMory:STORe:CHANnel:CLEar

Description Deletes the instrument state for each channel (saved with the :MMEM:STOR:CHAN command) in all the registers. (No query)

Example of use 10 OUTPUT 717; ":MMEM:STOR:CHAN:CLE"

Related commands :MMEM:STOR:CHAN on page 352

Equivalent key **[Save/Recall] - Save Channel - Clear States - OK**

:MMEM:STOR:CHAN:COEF

Syntax :MMEMory:STORe:CHANnel:COEFFicient {A|B|C|D}

Description Saves the calibration coefficient of the active channel (specified with the :DISP:WIND{1-4}:ACT command) into the specified register (volatile memory).

Notice that, if an instrument state has been saved already in the specified register, its contents are overwritten. (No query)

Parameters

	Description
A	Specifies register A.
B	Specifies register B.
C	Specifies register C.
D	Specifies register D.

Example of use 10 OUTPUT 717; ":MMEM:STOR:CHAN:COEF A"

Related commands :MMEM:LOAD:CHAN:COEF on page 345

Equivalent key **[Save/Recall] - Save Channel - Cal Only A|B|C|D**

NOTE The calibration coefficient registers A to D are different from the channel state registers A to D. :MMEM:STOR:CHAN command does not affect the calibration coefficient registers.

:MMEM:STOR:FDAT

Syntax :MMEMory:STORe:FDATa <string>

Description Saves the formatted data array of the active trace (specified with the :CALC{1-4}:PAR{1-4}:SEL command) of the active channel (specified with the :DISP:WIND{1-4}:ACT command) into a file in the CSV format.

Specify the file name with the .csv extension. If you want to specify a file on the floppy disk drive, you need to add "A:" at the beginning of the file name. When you use directory names and file name, separate them with "/" (slash) or "\" (backslash).

Notice that, if a file with the specified file name exists, its contents are overwritten. (No query)

Parameters

	<string>
Description	File name in which you want to save the formatted data array
Range	254 characters or less

Example of use

```
10 OUTPUT 717;":MMEM:STOR:FDAT "Result/Trace01.csv""
10 OUTPUT 717;":MMEM:STOR:FDAT "A:Trace01.csv""
```

Related commands :DISP:WIND{1-4}:ACT on page 316
:CALC{1-4}:PAR{1-4}:SEL on page 284

Equivalent key **[Save/Recall] - Save Trace Data**

:MMEM:STOR:IMAG

Syntax :MMEMory:STORe:IMAGe <string>

Description Saves the display image on the LCD display at the execution of the command into a file in the bitmap (.bmp) or portable network graphics (.png) format.

Specify the file name with the .bmp or .png extension. If you want to specify a file on the floppy disk drive, you need to add "A:" at the beginning of the file name. When you use directory names and file name, separate them with "/" (slash) or "\" (backslash).

Notice that, if a file with the specified file name exists, its contents are overwritten. (No query)

Parameters

	<string>
Description	File name in which you want to save the display image on the LCD display
Range	254 characters or less

Example of use

```
10 OUTPUT 717;":MMEM:STOR:IMAG ""Result/Image01.bmp""
10 OUTPUT 717;":MMEM:STOR:IMAG ""A:Image01.png""
```

Equivalent key **[System] - Dump Screen Image**

When performing the operation from the front panel, the image on the LCD display memorized in the volatile memory (clipboard) (the image on the LCD display when the **[Capture]** key is pressed) is saved. Notice that, if no image is memorized in the clipboard, in the same way as the command, the image on the LCD display at the execution is memorized in the clipboard and then it is saved.

:MMEM:STOR:LIM

Syntax :MMEMory:STORe:LIMit <string>

Description Saves the limit table for the active trace (specified with the :CALC{1-4}:PAR{1-4}:SEL command) of the active channel (specified with the :DISP:WIND{1-4}:ACT command) into a file in the CSV format.

Specify the file name with the .csv extension. If you want to specify a file on the floppy disk drive, you need to add "A:" at the beginning of the file name. When you use directory names and file name, separate them with "/" (slash) or "\" (backslash).

Notice that, if a file with the specified file name exists, its contents are overwritten. (No query)

Parameters

	<string>
Description	File name in which you want to save the limit table
Range	254 characters or less

Example of use

```
10 OUTPUT 717;":MMEM:STOR:LIM ""Test1/Limit01.csv""  
10 OUTPUT 717;":MMEM:STOR:LIM ""A:Limit01.csv""
```

Related commands :DISP:WIND{1-4}:ACT on page 316
:CALC{1-4}:PAR{1-4}:SEL on page 284

Equivalent key **[Analysis] - Limit Test - Edit Limit Line - Export to CSV File**

:MMEM:STOR:PROG

Syntax :MMEMory:STORe:PROGram <string>

Description Saves a VBA project opened on the VBA editor into a file.

Specify the file name with the .vba extension. If you want to specify a file on the floppy disk drive, you need to add "A:" at the beginning of the file name. When you use directory names and file name, separate them with "/" (slash) or "\" (backslash).

Notice that, if a file with the specified file name exists, its contents are overwritten. (No query)

Parameters

	<string>
Description	File name in which you want to save the VBA project
Range	254 characters or less

Example of use

```
10 OUTPUT 717;":MMEM:STOR:PROG ""Test1/Test1_01.vba""
10 OUTPUT 717;":MMEM:STOR:PROG ""A:Test1_01.vba""
```

Related commands :MMEM:LOAD:PROG on page 347

Equivalent key **[Macro Setup] - Save VBA Project**

:MMEM:STOR:RLIM

Syntax :MMEMory:STORe:RLIMit <string>

Description Saves the ripple limit table of the active trace (specified with the :CALC{1-4}:PAR{1-4}:SEL command) of the active channel (specified with the :DISP:WIND{1-4}:ACT command) into a file in the CSV format.

Specify the file name with the .sta extension. If you want to specify a file on the floppy disk drive, you need to add "A:" at the beginning of the file name. When you write directory names and the file name, separate them with a "/" (slash) or "\" (backslash).

Note that if a file with the specified file name already exists, its contents will be overwritten. (No query)

Parameters

	<string>
Description	File name used to save the ripple limit table.
Range	254 characters or less

Example of use

```
10 OUTPUT 717;":MMEM:STOR:RLIM ""RTest1/Rlim01.csv""
10 OUTPUT 717;":MMEM:STOR:RLIM ""A:Rlim01.csv""
```

Related commands :MMEM:LOAD:RLIM on page 348
:DISP:WIND{1-4}:ACT on page 316
:CALC{1-4}:PAR{1-4}:SEL on page 284

Equivalent key **[Analysis] - Ripple Limit - Edit Ripple Limit - Export to CSV File**

:MMEM:STOR:SALL

Syntax :MMEMory:STORe:SALL {ON|OFF|1|0}
:MMEMory:STORe:SALL?

Description Selects whether to save the setting of all channels/traces or that of the displayed channels/traces only as the instrument state to be saved.

Parameters

	Description
ON or 1	Specifies the setting of all channels/traces as the target to be saved.
OFF or 0 (preset value)	Specifies the setting of displayed channels/traces only as the target to be saved.

Query response {1|0}<newline><^END>

Example of use

```
10 OUTPUT 717;":MMEM:STOR:SALL ON"
20 OUTPUT 717;":MMEM:STOR:SALL?"
30 ENTER 717;A
```

Related commands :MMEM:STOR on page 351

Equivalent key **[Save/Recall] - Channel/Trace**

:MMEM:STOR:SEGM

Syntax :MMEMory:STORe:SEGMent <string>

Description Saves the segment sweep table for the active channel (specified with the :DISP:WIND{1-4}:ACT command) into a file in the CSV format.

Specify the file name with the .csv extension. If you want to specify a file on the floppy disk drive, you need to add "A:" at the beginning of the file name. When you use directory names and file name, separate them with "/" (slash) or "\" (backslash).

Notice that, if a file with the specified file name exists, its contents are overwritten. (No query)

Parameters

	<string>
Description	File name in which you want to save the segment sweep table
Range	254 characters or less

Example of use

```
10 OUTPUT 717;":MMEM:STOR:SEGM ""Test1/Segm01.csv""
10 OUTPUT 717;":MMEM:STOR:SEGM ""A:Segm01.csv""
```

Related commands :MMEM:LOAD:SEGM on page 349
:DISP:WIND{1-4}:ACT on page 316

Equivalent key **[Sweep Setup] - Edit Segment Table - Export to CSV File**

:MMEM:STOR:STYP

Syntax :MMEMory:STORe:STYPe {STATe|CSTate|DSTate|CDSTate}
:MMEMory:STORe:STYPe?

Description Selects the contents saved when saving the instrument state into a file with the :MMEM:STOR command.

Parameters

	Description
STATe	Specifies the save of the measurement conditions ^{*1} only.
CSTate (preset value)	Specifies the save of the measurement conditions ^{*1} and the calibration state.
DSTate	Specifies the save of the measurement conditions ^{*1} and the formatted data array.
CDSTate	Specifies the save of the measurement conditions ^{*1} , the calibration state, and the formatted data array.

*1. For details about the measurement conditions that can be saved, refer to the *User's Guide*.

Query response {STAT|CST|DST|CDST}<newline><^END>

Example of use

```
10 OUTPUT 717;":MMEM:STOR:STYP CDST"
20 OUTPUT 717;":MMEM:STOR:STYP?"
30 ENTER 717;A$
```

Related commands :MMEM:STOR on page 351

Equivalent key **[Save/Recall] - Save Type - State Only|State & Cal|State & Trace|All**

:MMEM:TRAN

Syntax :MMEMory:TRANsfer <string>,<block>
 :MMEMory:TRANsfer? <string>

Description Writes/reads data to/from a file on the built-in storage device of the E5061A/E5062A.

By reading out data with this command and writing it to a file on the external controller, file transfer from the E5061A/E5062A to the external controller can be realized. On the other hand, by reading out data from the external controller and writing it to a file on the E5061A/E5062A with this command, file transfer from the external controller to the E5061A/E5062A can be realized.

Specify the file name with the extension. If you want to specify a file on the floppy disk drive, you need to add "A:" at the beginning of the file name. When you use directory names and file name, separate them with "/" (slash) or "\" (backslash).

If a file with the specified file name already exists for writing or if the specified file does not exist for reading out (Query), an error occurs and the command is ignored.

Parameters

	<string>	<block>
Description	File name on the E5061A/E5062A	Data written on/read out from the file.
Range	254 characters or less	GPIB: 20 Mbytes or less LAN: 100 Kbytes or less

Query response {block}<newline><^END>

Example of use

```

10 OUTPUT 717;":MMEM:TRAN ""Trace01.csv"",#6012345";Dat$
10 OUTPUT 717;":MMEM:TRAN? ""Trace01.csv""
20 ENTER 717 USING "#,A";A$
30 ENTER 717 USING "#,A";Digit$
40 Img$="#,"&Digit$&"A"
50 ENTER 717 USING Img$;Byte$
60 Img$=Byte$&"A"
70 ALLOCATE Dat$[VAL(Byte$)]
80 ENTER 717 USING Img$;Dat$
  
```

Equivalent key No equivalent key is available on the front panel.

:OUTP

Syntax :OUTPut[:STATe] {ON|OFF|1|0}
:OUTPut[:STATe]?

Description Turns on/off of the stimulus signal output. You cannot perform measurement until you turn on the stimulus signal output.

Parameters

	Description
ON or 1 (preset value)	Turns on the stimulus signal output.
OFF or 0	Turns off the stimulus signal output.

Query response {1|0}<newline><^END>

Example of use
10 OUTPUT 717;":OUTP ON"
20 OUTPUT 717;":OUTP?"
30 ENTER 717;A

Equivalent key **[Sweep Setup] - Power - RF Out**

:PROG:CAT?

Syntax :PROG:CATalog?

Description Reads out the list of all executable VBA macros (procedures defined by Public including the VBA project loaded on the VBA editor). (Query only)

Query response {string}<newline><^END>

The character string in the following format, in which each macro is separated by a comma (.), is read out.

"{macro 1},{macro 2},...,{macro N}"

Where N is the total number of VBA macros.

{macro n}: VBA macro name (module name.procedure name)

Example of use
10 DIM A\$[1000]
20 OUTPUT 717;":PROG:CAT?"
30 ENTER 717;A\$

Equivalent key **[Macro Setup] - Select Macro**

:PROG:NAME

Syntax :PROG:NAME[:SELEcted]:NAME <string>
:PROG:NAME[:SELEcted]:NAME?

Description Selects the VBA macro controlled with the :PROG:STAT command.
Selectable VBA macro names can be read out with the :PROG:CAT? command.

Parameters

	<string>
Description	VBA macro name (module name.procedure name)
Range	254 characters or less
Preset value	""

Query response {string}<newline><^END>

Example of use

```

10 OUTPUT 717;":PROG:NAME ""Module1.main""
20 OUTPUT 717;":PROG:NAME?"
30 ENTER 717;A$

```

Related commands :PROG:CAT? on page 363
:PROG:STAT on page 365

Equivalent key **[Macro Setup] - Select Macro**

NOTE When performing the operation from the front panel, you select the VBA macro and execute it at the same time.

:PROG:STAT

Syntax :PROG:STAT[:SELection]:STATe {STOP|RUN}
:PROG:STAT[:SELection]:STATe?

Description Reads out the control/state of the VBA macro selected with the :PROG:STAT command.

Parameters

	Description
STOP (preset value)	Specifies stop.
RUN	Specifies run.

Query response {STOP|RUN}<newline><^END>

Example of use

```
10 OUTPUT 717;":PROG:STAT RUN"
20 OUTPUT 717;":PROG:STAT?"
30 ENTER 717;A$
```

Related commands :PROG:NAME on page 364

Equivalent key **[Macro Break]** (to stop)
[Macro Setup] - Select Macro (to run)

NOTE When performing the operation from the front panel, you select the VBA macro and execute it at the same time.

:SENS:CORR:COLL:ECAL:PATH?

Syntax :SENSe:CORRection:COLLect:ECAL:PATH? <numeric>

Description Reads out which port of the ECal module is connected with the specified port of the E5061A/E5062A. (Query only)

Parameters

	<numeric>
Description	Port number
Range	1 to 2
Resolution	1

Query response {0|1|2|3|4}<newline><^END>

	Description
0	Nothing is connected.
1	Port A is connected.
2	Port B is connected.
3	Port C is connected.
4	Port D is connected.

Example of use
10 OUTPUT 717;":SENS1:CORR:COLL:ECAL:PATH? 1"
20 ENTER 717;A

Equivalent key No equivalent key is available on the front panel.

:SENS:CORR:IMP

Syntax :SENSe:CORRection:IMPedance[:INPut][:MAGNitude] <numeric>
:SENSe:CORRection:IMPedance[:INPut][:MAGNitude]?

Description Sets the system characteristic impedance (Z0) value.

NOTE This command is available with the firmware version 3.01 or greater.

Parameters

	<numeric>
Description	System Z0 value
Range	1E-3 to 1000
Preset value	50 or 75
Unit	Ω (ohm)
Resolution	0.001

If the specified parameter is out of the allowable setup range, the minimum value (if the lower limit of the range is not reached) or the maximum value (if the upper limit of the range is exceeded) is set.

Query response {numeric}<newline><^END>

Example of use

```
10  OUTPUT 717;":SENS:CORR:IMP 75"
20  OUTPUT 717;":SENS:CORR:IMP?"
30  ENTER 717;A
```

Equivalent key **[Cal] - Set Z0**

:SENS{1-4}:AVER:CLE

Syntax	:SENSe{[1] 2 3 4}:AVERage:CLEar
Description	Clears the measurement data used for averaging of channel 1 (:SENS1) to channel 4 (:SENS4). Measurement data before the execution of this command is not used for averaging. (No query)
Example of use	10 OUTPUT 717; ":SENS1:AVER:CLE"
Related commands	:SENS{1-4}:AVER on page 368 :SENS{1-4}:AVER:COUN on page 369

Equivalent key **[Avg] - Averaging Restart**

:SENS{1-4}:AVER

Syntax	:SENSe{[1] 2 3 4}:AVERage[:STATe] {ON OFF 1 0} :SENSe{[1] 2 3 4}:AVERage[:STATe]?
Description	Turns ON/OFF the averaging function of channel 1 (:SENS1) to channel 4 (:SENS4).
Parameters	

	Description
ON or 1	Turns ON the averaging function.
OFF or 0 (preset value)	Turns OFF the averaging function.

Query response	{1 0}<newline><^END>
Example of use	10 OUTPUT 717; ":SENS1:AVER ON" 20 OUTPUT 717; ":SENS1:AVER?" 30 ENTER 717;A
Related commands	:SENS{1-4}:AVER:CLE on page 368 :SENS{1-4}:AVER:COUN on page 369
Equivalent key	[Avg] - Averaging

:SENS{1-4}:AVER:COUN

Syntax :SENSe{[1]2|3|4}:AVERage:COUNT <numeric>
:SENSe{[1]2|3|4}:AVERage:COUNT?

Description Sets the averaging factor of channel 1 (:SENS1) to channel 4 (:SENS4).

Parameters

	<numeric>
Description	Averaging factor
Range	1 to 999
Preset value	16
Resolution	1

If the specified parameter is out of the allowable setup range, the minimum value (if the lower limit of the range is not reached) or the maximum value (if the upper limit of the range is exceeded) is set.

Query response {numeric}<newline><^END>

Example of use
10 OUTPUT 717;":SENS1:AVER:COUN 4"
20 OUTPUT 717;":SENS1:AVER:COUN?"
30 ENTER 717;A

Related commands :SENS{1-4}:AVER on page 368
:SENS{1-4}:AVER:CLE on page 368

Equivalent key **[Avg] - Avg Factor**

:SENS{1-4}:BAND

Syntax :SENSe{[1]|2|3|4}:BANDwidth[:RESolution] <numeric>
:SENSe{[1]|2|3|4}:BANDwidth[:RESolution]?

Description Sets the IF bandwidth of channel 1 (:SENS1) to channel 4 (:SENS4).
This command provides the same function as the :SENS{1-4}:BWID command.

Parameters

	<numeric>
Description	IF bandwidth
Range	10 to 30000
Preset value	30000
Unit	Hz (hertz)
Resolution	In steps of 1 or 3

If the specified parameter is out of the allowable setup range, the minimum value (if the lower limit of the range is not reached) or the maximum value (if the upper limit of the range is exceeded) is set.

Query response {numeric}<newline><^END>

Example of use
10 OUTPUT 717;":SENS1:BAND 1E3"
20 OUTPUT 717;":SENS1:BAND?"
30 ENTER 717;A

Related commands :SENS{1-4}:BWID on page 371

Equivalent key [Avg] - IF Bandwidth

:SENS{1-4}:BWID

Syntax :SENSe{[1]|2|3|4}:BWIDth[:RESolution] <numeric>
:SENSe{[1]|2|3|4}:BWIDth[:RESolution]?

Description Sets the IF bandwidth of channel 1 (:SENS1) to channel 4 (:SENS4).
This command provides the same function as the :SENS{1-4}:BAND command.

Parameters

	<numeric>
Description	IF bandwidth
Range	10 to 30000
Preset value	30000
Unit	Hz (hertz)
Resolution	In steps of 1 or 3

If the specified parameter is out of the allowable setup range, the minimum value (if the lower limit of the range is not reached) or the maximum value (if the upper limit of the range is exceeded) is set.

Query response {numeric}<newline><^END>

Example of use
10 OUTPUT 717;":SENS1:BWID 1E3"
20 OUTPUT 717;":SENS1:BWID?"
30 ENTER 717;A

Related commands :SENS{1-4}:BAND on page 370

Equivalent key **[Avg] - IF Bandwidth**

:SENS{1-4}:CORR:CLE

Syntax :SENSe{[1]|2|3|4}:CORRection:CLEar

Description Clears all calibration coefficient and measured standard data for calibration in the channel 1 (SENS 1) to channel 4 (SENS 4).

Example of use 10 OUTPUT 717;":SENS1:CORR:CLE"

Related commands

Equivalent key **[Cal] - Clear All**

:SENS{1-4}:CORR:COEF?

Syntax :SENSe{[1]|2|3|4}:CORRection:COEFFicient[:DATA]? {ES|ER|ED|EL|ET|EX}, <numeric 1>, <numeric 2>

Description Returns the calibration coefficient for specified channel.

Parameters

	<numeric>
ES	Source match
ER	Reflection tracking
ED	Directivity
EL	Load match
ET	Transmission tracking
EX	Isolation
numeric 1	Response port
numeric 2	Stimulus port

If ES, ER, or ED is used, the response port and the stimulus port must be the same, while EL, ET, or EX is used, the response port and the stimulus port must be different.

Query response {numeric 1},..., {numeric NOP×2} <newline><^END>

	Description
{numeric n×2-1}	Real part of the data (complex number) at the n-th measurement point.
{numeric n×2}	Imaginary part of the data (complex number) at the n-th measurement point.

Where NOP is the number of measurement points and n is an integer between 1 and NOP.

Example of use

```
10 DIM A(1:201)
20 OUTPUT 717; ":SENS1:CORR:COEF? EL, 1, 2"
30 ENTER 717; A(*)
```

Equivalent key No equivalent key is available on the front panel.

:SENS{1-4}:CORR:COLL:CKIT

Syntax :SENSe{[1]2|3|4}:CORRection:COLLect:CKIT[:SElect] <numeric>
:SENSe{[1]2|3|4}:CORRection:COLLect:CKIT[:SElect]?

Description Selects the calibration kit of channel 1 (:SENS1) to channel 4 (:SENS4).

Parameters

	<numeric>
Description	Number of calibration kit *1
Range	1 to 10
Preset value	50 ohm test set: 5, 75 ohm test set: 6
Resolution	1

*1. The numbers of 1 to 10 assigned from the top to the calibration kit names displayed on the softkey labels when performing **[Cal] - Cal Kit**.

If the specified parameter is out of the allowable setup range, an error occurs and the command is ignored.

Query response {numeric}<newline><^END>

Example of use

```
10 OUTPUT 717;":SENS1:CORR:COLL:CKIT 3"
20 OUTPUT 717;":SENS1:CORR:COLL:CKIT?"
30 ENTER 717;A
```

Equivalent key **[Cal] - Cal Kit**

:SENS{1-4}:CORR:COLL:CKIT:LAB

Syntax :SENSe{[1]|2|3|4}:CORRection:COLLect:CKIT:LABel <string>
 :SENSe{[1]|2|3|4}:CORRection:COLLect:CKIT:LABel?

Description Sets a calibration kit name for the calibration kit selected for channel 1 (:SENS1) to channel 4 (:SENS4).

Parameters

	<string>
Description	Calibration kit name
Range	254 characters or less
Preset value	Varies depending on the calibration kit number as follows: 1: "85033E" 2: "85033D" 3: "85052D" 4: "85032F" 5: "85032B" 6: "85036B/E" 7: "85039B" 8: "85038A/F/M" 9 to 10: "User"

Query response {string}<newline><^END>

Example of use
 10 OUTPUT 717;":SENS1:CORR:COLL:CKIT:LAB "MY_KIT"
 20 OUTPUT 717;":SENS1:CORR:COLL:CKIT:LAB?"
 30 ENTER 717;A\$

Related commands :SENS{1-4}:CORR:COLL:CKIT on page 373

Equivalent key **[Cal] - Modify Cal Kit - Label Kit**

:SENS{1-4}:CORR:COLL:CKIT:ORD:LOAD

Syntax :SENSe{[1]|2|3|4}:CORRection:COLLect:CKIT:ORDer:LOAD <numeric 1>,<numeric 2>

:SENSe{[1]|2|3|4}:CORRection:COLLect:CKIT:ORDer:LOAD? <numeric 1>

Description For the calibration kit selected for channel 1 (:SENS1) to channel 4 (:SENS4), selects the standard used for the load measurement of the specified port.

Parameters

	<numeric 1>	<numeric 2>
Description	Port number	Standard number
Range	1 to 2	1 to 21
Resolution	1	1

If the specified parameter is out of the allowable setup range, an error occurs and the command is ignored.

Query response {numeric 2}<newline><^END>

Example of use
 10 OUTPUT 717;":SENS1:CORR:COLL:CKIT:ORD:LOAD 1,9"
 20 OUTPUT 717;":SENS1:CORR:COLL:CKIT:ORD:LOAD? 1"
 30 ENTER 717;A

Related commands :SENS{1-4}:CORR:COLL:CKIT on page 373

Equivalent key [Cal] - Modify Cal Kit - Specify CLSs - Load - Port 1|Port 2

:SENS{1-4}:CORR:COLL:CKIT:ORD:OPEN

Syntax :SENSe{[1]|2|3|4}:CORRection:COLLect:CKIT:ORDer:OPEN <numeric 1>,<numeric 2>
:SENSe{[1]|2|3|4}:CORRection:COLLect:CKIT:ORDer:OPEN? <numeric 1>

Description For the calibration kit selected for channel 1 (:SENS1) to channel 4 (:SENS4), selects the standard used for the open measurement of the specified port.

Parameters

	<numeric 1>	<numeric 2>
Description	Port number	Standard number
Range	1 to 2	1 to 21
Resolution	1	1

If the specified parameter is out of the allowable setup range, an error occurs and the command is ignored.

Query response {numeric 2}<newline><^END>

Example of use
10 OUTPUT 717;":SENS1:CORR:COLL:CKIT:ORD:OPEN 1,2"
20 OUTPUT 717;":SENS1:CORR:COLL:CKIT:ORD:OPEN? 1"
30 ENTER 717;A

Related commands :SENS{1-4}:CORR:COLL:CKIT on page 373

Equivalent key **[Cal] - Modify Cal Kit - Specify CLSs - Open - Port 1|Port 2**

:SENS{1-4}:CORR:COLL:CKIT:ORD:SHOR

Syntax :SENSe{[1]|2|3|4}:CORRection:COLLect:CKIT:ORDer:SHORt <numeric 1>,<numeric 2>

:SENSe{[1]|2|3|4}:CORRection:COLLect:CKIT:ORDer:SHORt? <numeric 1>

Description For the calibration kit selected for channel 1 (:SENS1) to channel 4 (:SENS4), selects the standard used for the short measurement of the specified port.

Parameters

	<numeric 1>	<numeric 2>
Description	Port number	Standard number
Range	1 to 2	1 to 21
Resolution	1	1

If the specified parameter is out of the allowable setup range, an error occurs and the command is ignored.

Query response {numeric 2}<newline><^END>

Example of use

```
10 OUTPUT 717;":SENS1:CORR:COLL:CKIT:ORD:SHOR 1,1"
20 OUTPUT 717;":SENS1:CORR:COLL:CKIT:ORD:SHOR? 1"
30 ENTER 717;A
```

Related commands :SENS{1-4}:CORR:COLL:CKIT on page 373

Equivalent key **[Cal] - Modify Cal Kit - Specify CLSs - Short - Port 1|Port 2**

:SENS{1-4}:CORR:COLL:CKIT:ORD:THRU

Syntax :SENSe{[1]|2|3|4}:CORRection:COLLect:CKIT:ORDe:THRU <numeric 1>,<numeric 2>,<numeric 3>
:SENSe{[1]|2|3|4}:CORRection:COLLect:CKIT:ORDe:THRU? <numeric 1>,<numeric 2>

Description For the calibration kit selected for channel 1 (:SENS1) to channel 4 (:SENS4), selects the standard used for the thru measurement between the specified 2 ports.

Parameters

	<numeric 1>	<numeric 2>	<numeric 3>
Description	Port number 1	Port number 2	Standard number
Range	1 to 2	1 to 2	1 to 21
Resolution	1	1	1

For <numeric 1> and <numeric 2>, you must specify a different port number. If you specify the same port number, an error occurs and the command is ignored.

If the specified parameter is out of the allowable setup range, an error occurs and the command is ignored.

Query response {numeric 3}<newline><^END>

Example of use
10 OUTPUT 717;":SENS1:CORR:COLL:CKIT:ORD:THRU 1,2,11"
20 OUTPUT 717;":SENS1:CORR:COLL:CKIT:ORD:THRU? 1,2"
30 ENTER 717;A

Related commands :SENS{1-4}:CORR:COLL:CKIT on page 373

Equivalent key **[Cal] - Modify Cal Kit - Specify CLSs - Thru**

:SENS{1-4}:CORR:COLL:CKIT:RES

Syntax :SENSe{[1]|2|3|4}:CORRection:COLLect:CKIT:RESeT

Description Resets the calibration kit selected for channel 1 (:SENS1) to channel 4 (:SENS4) to the factory setting state. (No query)

Example of use 10 OUTPUT 717;":SENS1:CORR:COLL:CKIT:RES"

Related commands :SENS{1-4}:CORR:COLL:CKIT on page 373

Equivalent key **[Cal] - Modify Cal Kit - Restore Cal Kit**

:SENS{1-4}:CORR:COLL:CKIT:STAN{1-21}:ARB

Syntax :SENSe{[1]|2|3|4}:CORRection:COLLect:CKIT:STAN{[1]|2|3|4|5|6|7|8|9|10|11|12|13|14|15|16|17|18|19|20|21}:ARBitrary <numeric>
:SENSe{[1]|2|3|4}:CORRection:COLLect:CKIT:STAN{[1]|2|3|4|5|6|7|8|9|10|11|12|13|14|15|16|17|18|19|20|21}:ARBitrary?

Description For the calibration kit selected for channel 1 (:SENS1) to channel 4 (:SENS4), sets the value of the arbitrary impedance of the standard1 (:STAN1) to standard 21 (:STAN21).

Parameters

	<numeric>
Description	Arbitrary impedance
Range	-1E18 to 1E18
Preset value	Varies depending on the calibration kit and the standard.
Unit	Ω (ohm)

If the specified parameter is out of the allowable setup range, the minimum value (if the lower limit of the range is not reached) or the maximum value (if the upper limit of the range is exceeded) is set.

Query response {numeric}<newline><^END>

Example of use

```
10  OUTPUT 717;":SENS1:CORR:COLL:CKIT:STAN1:ARB 50.5"
20  OUTPUT 717;":SENS1:CORR:COLL:CKIT:STAN1:ARB?"
30  ENTER 717;A
```

Equivalent key **[Cal] - Modify Cal Kit - Define STDs - no. name^{*1} - Arb. Impedance**

^{*1}no: standard number (1 to 21), name: standard name (variable)

:SENS{1-4}:CORR:COLL:CKIT:STAN{1-21}:C0

Syntax :SENSe{[1]|2|3|4}:CORRection:COLLect:CKIT:STAN {[1]|2|3|4|5|6|7|8|9|10|11|12|13|14|15|16|17|18|19|20|21}:C0 <numeric>
:SENSe{[1]|2|3|4}:CORRection:COLLect:CKIT:STAN {[1]|2|3|4|5|6|7|8|9|10|11|12|13|14|15|16|17|18|19|20|21}:C0?

Description For the calibration kit selected for channel 1 (:SENS1) to channel 4 (:SENS4), sets the value of the C0 of the standard1 (:STAN1) to standard 21 (:STAN21).

Parameters

	<numeric>
Description	C0
Range	-1E18 to 1E18
Preset value	Varies depending on the calibration kit and the standard.
Unit	fF (femtofarad)

If the specified parameter is out of the allowable setup range, the minimum value (if the lower limit of the range is not reached) or the maximum value (if the upper limit of the range is exceeded) is set.

Query response {numeric}<newline><^END>

Example of use
10 OUTPUT 717;":SENS1:CORR:COLL:CKIT:STAN1:C0 12.3"
20 OUTPUT 717;":SENS1:CORR:COLL:CKIT:STAN1:C0?"
30 ENTER 717;A

Equivalent key **[Cal] - Modify Cal Kit - Define STDs - no. name^{*1} - C0**

*1.no: standard number (1 to 21), name: standard name (variable)

:SENS{1-4}:CORR:COLL:CKIT:STAN{1-21}:C1

Syntax :SENSe{[1]|2|3|4}:CORRection:COLLect:CKIT:STAN{[1]|2|3|4|5|6|7|8|9|10|11|12|13|14|15|16|17|18|19|20|21}:C1 <numeric>
:SENSe{[1]|2|3|4}:CORRection:COLLect:CKIT:STAN{[1]|2|3|4|5|6|7|8|9|10|11|12|13|14|15|16|17|18|19|20|21}:C1?

Description For the calibration kit selected for channel 1 (:SENS1) to channel 4 (:SENS4), sets the value of the C1 of the standard1 (:STAN1) to standard 21 (:STAN21).

Parameters

	<numeric>
Description	C1
Range	-1E18 to 1E18
Preset value	Varies depending on the calibration kit and the standard.
Unit	1E-27 F/Hz (1E-27 farad/hertz)

If the specified parameter is out of the allowable setup range, the minimum value (if the lower limit of the range is not reached) or the maximum value (if the upper limit of the range is exceeded) is set.

Query response {numeric}<newline><^END>

Example of use

```
10  OUTPUT 717;":SENS1:CORR:COLL:CKIT:STAN1:C1 12.3"
20  OUTPUT 717;":SENS1:CORR:COLL:CKIT:STAN1:C1?"
30  ENTER 717;A
```

Equivalent key **[Cal] - Modify Cal Kit - Define STDs - no. name^{*1} - C1**

^{*1}.no: standard number (1 to 21), name: standard name (variable)

:SENS{1-4}:CORR:COLL:CKIT:STAN{1-21}:C2

Syntax :SENSe{[1]|2|3|4}:CORRection:COLLect:CKIT:STAN{[1]|2|3|4|5|6|7|8|9|10|11|12|13|14|15|16|17|18|19|20|21}:C2 <numeric>
:SENSe{[1]|2|3|4}:CORRection:COLLect:CKIT:STAN{[1]|2|3|4|5|6|7|8|9|10|11|12|13|14|15|16|17|18|19|20|21}:C2?

Description For the calibration kit selected for channel 1 (:SENS1) to channel 4 (:SENS4), sets the value of the C2 of the standard1 (:STAN1) to standard 21 (:STAN21).

Parameters

	<numeric>
Description	C2
Range	-1E18 to 1E18
Preset value	Varies depending on the calibration kit and the standard.
Unit	1E-36 F/Hz ² (1E-36 farad/hertz ²)

If the specified parameter is out of the allowable setup range, the minimum value (if the lower limit of the range is not reached) or the maximum value (if the upper limit of the range is exceeded) is set.

Query response {numeric}<newline><^END>

Example of use
10 OUTPUT 717;":SENS1:CORR:COLL:CKIT:STAN1:C2 12.3"
20 OUTPUT 717;":SENS1:CORR:COLL:CKIT:STAN1:C2?"
30 ENTER 717;A

Equivalent key [Cal] - Modify Cal Kit - Define STDs - no. name^{*1} - C2

*1.no: standard number (1 to 21), name: standard name (variable)

:SENS{1-4}:CORR:COLL:CKIT:STAN{1-21}:C3

Syntax :SENSe{[1]|2|3|4}:CORRection:COLLect:CKIT:STAN{[1]|2|3|4|5|6|7|8|9|10|11|12|13|14|15|16|17|18|19|20|21}:C3 <numeric>
:SENSe{[1]|2|3|4}:CORRection:COLLect:CKIT:STAN{[1]|2|3|4|5|6|7|8|9|10|11|12|13|14|15|16|17|18|19|20|21}:C3?

Description For the calibration kit selected for channel 1 (:SENS1) to channel 4 (:SENS4), sets the value of the C3 of the standard1 (:STAN1) to standard 21 (:STAN21).

Parameters

	<numeric>
Description	C3
Range	-1E18 to 1E18
Preset value	Varies depending on the calibration kit and the standard.
Unit	1E-45 F/Hz ³ (1E-45 farad/hertz ³)

If the specified parameter is out of the allowable setup range, the minimum value (if the lower limit of the range is not reached) or the maximum value (if the upper limit of the range is exceeded) is set.

Query response {numeric}<newline><^END>

Example of use

```
10  OUTPUT 717;":SENS1:CORR:COLL:CKIT:STAN1:C3 12.3"
20  OUTPUT 717;":SENS1:CORR:COLL:CKIT:STAN1:C3?"
30  ENTER 717;A
```

Equivalent key **[Cal] - Modify Cal Kit - Define STDs - no. name^{*1} - C3**

^{*1}.no: standard number (1 to 21), name: standard name (variable)

:SENS{1-4}:CORR:COLL:CKIT:STAN{1-21}:DEL

Syntax :SENSe{[1]|2|3|4}:CORRection:COLLect:CKIT:STAN {[1]|2|3|4|5|6|7|8|9|10|11|12|13|14|15|16|17|18|19|20|21}:DELay <numeric>
:SENSe{[1]|2|3|4}:CORRection:COLLect:CKIT:STAN {[1]|2|3|4|5|6|7|8|9|10|11|12|13|14|15|16|17|18|19|20|21}:DELay?

Description For the calibration kit selected for channel 1 (:SENS1) to channel 4 (:SENS4), sets the value of the offset delay of the standard1 (:STAN1) to standard 21 (:STAN21).

Parameters

	<numeric>
Description	Offset delay
Range	-1E18 to 1E18
Preset value	Varies depending on the calibration kit and the standard.
Unit	s (second)

If the specified parameter is out of the allowable setup range, the minimum value (if the lower limit of the range is not reached) or the maximum value (if the upper limit of the range is exceeded) is set.

Query response {numeric}<newline><^END>

Example of use

```
10  OUTPUT 717; ":SENS1:CORR:COLL:CKIT:STAN1:DEL 12.3"
20  OUTPUT 717; ":SENS1:CORR:COLL:CKIT:STAN1:DEL?"
30  ENTER 717;A
```

Equivalent key **[Cal] - Modify Cal Kit - Define STDs - no. name^{*1} - Offset Delay**

^{*1}no: standard number (1 to 21), name: standard name (variable)

:SENS{1-4}:CORR:COLL:CKIT:STAN{1-21}:L0

Syntax :SENSe{[1]|2|3|4}:CORRection:COLLect:CKIT:STAN{[1]|2|3|4|5|6|7|8|9|10|11|12|13|14|15|16|17|18|19|20|21}:L0 <numeric>
:SENSe{[1]|2|3|4}:CORRection:COLLect:CKIT:STAN{[1]|2|3|4|5|6|7|8|9|10|11|12|13|14|15|16|17|18|19|20|21}:L0?

Description For the calibration kit selected for channel 1 (:SENS1) to channel 4 (:SENS4), sets the value of the L0 of the standard1 (:STAN1) to standard 21 (:STAN21).

Parameters

	<numeric>
Description	L0
Range	-1E18 to 1E18
Preset value	Varies depending on the calibration kit and the standard.
Unit	pH (picohenry)

If the specified parameter is out of the allowable setup range, the minimum value (if the lower limit of the range is not reached) or the maximum value (if the upper limit of the range is exceeded) is set.

Query response {numeric}<newline><^END>

Example of use

```
10  OUTPUT 717;":SENS1:CORR:COLL:CKIT:STAN1:L0 12.3"
20  OUTPUT 717;":SENS1:CORR:COLL:CKIT:STAN1:L0?"
30  ENTER 717;A
```

Equivalent key **[Cal] - Modify Cal Kit - Define STDs - no. name^{*1} - L0**

^{*1}no: standard number (1 to 21), name: standard name (variable)

:SENS{1-4}:CORR:COLL:CKIT:STAN{1-21}:L1

Syntax :SENSe{[1]|2|3|4}:CORRection:COLLect:CKIT:STAN {[1]|2|3|4|5|6|7|8|9|10|11|12|13|14|15|16|17|18|19|20|21}:L1 <numeric>
:SENSe{[1]|2|3|4}:CORRection:COLLect:CKIT:STAN {[1]|2|3|4|5|6|7|8|9|10|11|12|13|14|15|16|17|18|19|20|21}:L1?

Description For the calibration kit selected for channel 1 (:SENS1) to channel 4 (:SENS4), sets the value of the L1 of the standard1 (:STAN1) to standard 21 (:STAN21).

Parameters

	<numeric>
Description	L1
Range	-1E18 to 1E18
Preset value	Varies depending on the calibration kit and the standard.
Unit	1E-24 H/Hz (1E-24 henry/hertz)

If the specified parameter is out of the allowable setup range, the minimum value (if the lower limit of the range is not reached) or the maximum value (if the upper limit of the range is exceeded) is set.

Query response {numeric}<newline><^END>

Example of use
10 OUTPUT 717; ":SENS1:CORR:COLL:CKIT:STAN1:L1 12.3"
20 OUTPUT 717; ":SENS1:CORR:COLL:CKIT:STAN1:L1?"
30 ENTER 717;A

Equivalent key **[Cal] - Modify Cal Kit - Define STDs - no. name^{*1} - L1**

*1.no: standard number (1 to 21), name: standard name (variable)

:SENS{1-4}:CORR:COLL:CKIT:STAN{1-21}:L2

Syntax :SENSe{[1]|2|3|4}:CORRection:COLLEct:CKIT:STAN{[1]|2|3|4|5|6|7|8|9|10|11|12|13|14|15|16|17|18|19|20|21}:L2 <numeric>
:SENSe{[1]|2|3|4}:CORRection:COLLEct:CKIT:STAN{[1]|2|3|4|5|6|7|8|9|10|11|12|13|14|15|16|17|18|19|20|21}:L2?

Description For the calibration kit selected for channel 1 (:SENS1) to channel 4 (:SENS4), sets the value of the L2 of the standard1 (:STAN1) to standard 21 (:STAN21).

Parameters

	<numeric>
Description	L2
Range	-1E18 to 1E18
Preset value	Varies depending on the calibration kit and the standard.
Unit	1E-33 H/Hz ² (1E-33 henry/hertz ²)

If the specified parameter is out of the allowable setup range, the minimum value (if the lower limit of the range is not reached) or the maximum value (if the upper limit of the range is exceeded) is set.

Query response {numeric}<newline><^END>

Example of use
10 OUTPUT 717;":SENS1:CORR:COLL:CKIT:STAN1:L2 12.3"
20 OUTPUT 717;":SENS1:CORR:COLL:CKIT:STAN1:L2?"
30 ENTER 717;A

Equivalent key **[Cal] - Modify Cal Kit - Define STDs - no. name^{*1} - L2**

*1.no: standard number (1 to 21), name: standard name (variable)

:SENS{1-4}:CORR:COLL:CKIT:STAN{1-21}:L3

Syntax :SENSe{[1]|2|3|4}:CORRection:COLLect:CKIT:STAN {[1]|2|3|4|5|6|7|8|9|10|11|12|13|14|15|16|17|18|19|20|21}:L3 <numeric>
:SENSe{[1]|2|3|4}:CORRection:COLLect:CKIT:STAN {[1]|2|3|4|5|6|7|8|9|10|11|12|13|14|15|16|17|18|19|20|21}:L3?

Description For the calibration kit selected for channel 1 (:SENS1) to channel 4 (:SENS4), sets the value of the L3 of the standard1 (:STAN1) to standard 21 (:STAN21).

Parameters

	<numeric>
Description	L3
Range	-1E18 to 1E18
Preset value	Varies depending on the calibration kit and the standard.
Unit	1E-42 H/Hz ³ (1E-42 henry/hertz ³)

If the specified parameter is out of the allowable setup range, the minimum value (if the lower limit of the range is not reached) or the maximum value (if the upper limit of the range is exceeded) is set.

Query response {numeric}<newline><^END>

Example of use
10 OUTPUT 717;":SENS1:CORR:COLL:CKIT:STAN1:L3 12.3"
20 OUTPUT 717;":SENS1:CORR:COLL:CKIT:STAN1:L3?"
30 ENTER 717;A

Equivalent key **[Cal] - Modify Cal Kit - Define STDs - no. name^{*1} - L3**

*1.no: standard number (1 to 21), name: standard name (variable)

:SENS{1-4}:CORR:COLL:CKIT:STAN{1-21}:LAB

Syntax :SENSe{[1]|2|3|4}:CORRection:COLLect:CKIT:STAN{[1]|2|3|4|5|6|7|8|9|10|11|12|13|14|15|16|17|18|19|20|21}:LABel <string>
:SENSe{[1]|2|3|4}:CORRection:COLLect:CKIT:STAN{[1]|2|3|4|5|6|7|8|9|10|11|12|13|14|15|16|17|18|19|20|21}:LABel?

Description For the calibration kit selected for channel 1 (:SENS1) to channel 4 (:SENS4), sets the name of the standard1 (:STAN1) to standard 21 (:STAN21).

Parameters

	<string>
Description	Standard name
Range	254 characters or less
Preset value	Varies depending on the calibration kit and the standard.

Query response {string}<newline><^END>

Example of use
10 OUTPUT 717;":SENS1:CORR:COLL:CKIT:STAN1:LAB ""OPEN""
20 OUTPUT 717;":SENS1:CORR:COLL:CKIT:STAN1:LAB?"
30 ENTER 717;A\$

Equivalent key **[Cal] - Modify Cal Kit - Define STDs - no. name^{*1} - Label**

*1.no: standard number (1 to 21), name: standard name (variable)

:SENS{1-4}:CORR:COLL:CKIT:STAN{1-21}:LOSS

Syntax :SENSe{[1]|2|3|4}:CORRection:COLLect:CKIT:STAN {[1]|2|3|4|5|6|7|8|9|10|11|12|13|14|15|16|17|18|19|20|21}:LOSS <numeric>
:SENSe{[1]|2|3|4}:CORRection:COLLect:CKIT:STAN {[1]|2|3|4|5|6|7|8|9|10|11|12|13|14|15|16|17|18|19|20|21}:LOSS?

Description For the calibration kit selected for channel 1 (:SENS1) to channel 4 (:SENS4), sets the value of the offset loss of the standard1 (:STAN1) to standard 21 (:STAN21).

Parameters

	<numeric>
Description	Offset Loss
Range	-1E18 to 1E18
Preset value	Varies depending on the calibration kit and the standard.
Unit	Ω/s (ohm/second)

If the specified parameter is out of the allowable setup range, the minimum value (if the lower limit of the range is not reached) or the maximum value (if the upper limit of the range is exceeded) is set.

Query response {numeric}<newline><^END>

Example of use
10 OUTPUT 717;":SENS1:CORR:COLL:CKIT:STAN1:LOSS 12.3"
20 OUTPUT 717;":SENS1:CORR:COLL:CKIT:STAN1:LOSS?"
30 ENTER 717;A

Equivalent key **[Cal] - Modify Cal Kit - Define STDs - no. name^{*1} - Offset Loss**

*1.no: standard number (1 to 21), name: standard name (variable)

:SENS{1-4}:CORR:COLL:CKIT:STAN{1-21}:TYPE

Syntax :SENSe{[1]|2|3|4}:CORRection:COLLect:CKIT:STAN{[1]|2|3|4|5|6|7|8|9|10|11|12|13|14|15|16|17|18|19|20|21}:TYPE {OPEN|SHORt|LOAD|THRU|ARBI|NONE}
:SENSe{[1]|2|3|4}:CORRection:COLLect:CKIT:STAN{[1]|2|3|4|5|6|7|8|9|10|11|12|13|14|15|16|17|18|19|20|21}:TYPE?

Description For the calibration kit selected for channel 1 (:SENS1) to channel 4 (:SENS4), sets the standard type of the standard1 (:STAN1) to standard 21 (:STAN21).

Parameters

	Description
OPEN	Specifies open.
SHORt	Specifies short.
LOAD	Specifies load.
THRU	Specifies thru.
ARBI	Specify arbitrary impedance.
NONE	Specifies DUT of which theoretical values are 0.

Query response {OPEN|SHORt|LOAD|THRU|ARBI|NONE}<newline><^END>

Example of use 10 OUTPUT 717;" :SENS1:CORR:COLL:CKIT:STAN1:TYPE OPEN"
20 OUTPUT 717;" :SENS1:CORR:COLL:CKIT:STAN1:TYPE?"
30 ENTER 717;A\$

Equivalent key **[Cal] - Modify Cal Kit - Define STDs - no. name^{*1} - STD Type**

^{*1}no: standard number (1 to 21), name: standard name (variable)

:SENS{1-4}:CORR:COLL:CKIT:STAN{1-21}:Z0

Syntax :SENSe{[1]|2|3|4}:CORRection:COLLect:CKIT:STAN{[1]|2|3|4|5|6|7|8|9|10|11|12|13|14|15|16|17|18|19|20|21}:Z0 <numeric>
:SENSe{[1]|2|3|4}:CORRection:COLLect:CKIT:STAN{[1]|2|3|4|5|6|7|8|9|10|11|12|13|14|15|16|17|18|19|20|21}:Z0?

Description For the calibration kit selected for channel 1 (:SENS1) to channel 4 (:SENS4), sets the value of the Offset Z0 of the standard1 (:STAN1) to standard 21 (:STAN21).

Parameters

	<numeric>
Description	Offset Z0
Range	-1E18 to 1E18
Preset value	Varies depending on the calibration kit and the standard.
Unit	Ω (ohm)

If the specified parameter is out of the allowable setup range, the minimum value (if the lower limit of the range is not reached) or the maximum value (if the upper limit of the range is exceeded) is set.

Query response {numeric}<newline><^END>

Example of use

```
10  OUTPUT 717;":SENS1:CORR:COLL:CKIT:STAN1:Z0 50"
20  OUTPUT 717;":SENS1:CORR:COLL:CKIT:STAN1:Z0?"
30  ENTER 717;A
```

Equivalent key **[Cal] - Modify Cal Kit - Define STDs - no. name^{*1} - Offset Z0**

*1.no: standard number (1 to 21), name: standard name (variable)

:SENS{1-4}:CORR:COLL:ECAL:ERES

Syntax :SENSe{[1]|2|3|4}:CORRection:COLLect:ECAL:ERES <numeric 1>,<numeric 2>

Description Executes enhanced response calibration of channel 1 (:SENS1) to channel 4 (:SENS4) using the ECal (Electrical Calibration) module. If you execute this command when the ECal module is not connected, an error occurs and the command is ignored. (No query)

Parameters

	<numeric 1>	<numeric 2>
Description	Response port number	Stimulus port number
Range	1 to 2	1 to 2
Resolution	1	1

For each parameter, you must specify a different port number. If you specify the same port number for 2 or more parameters, an error occurs and the command is ignored.

Example of use

```
10 OUTPUT 717;":SENS1:CORR:COLL:ECAL:ERES 1,2"
20 OUTPUT 717;"*OPC?"
30 ENTER 717;A
```

Equivalent key **[Cal] - ECal - Enhanced Response - 2-1(S21)|1-2(S12)**

:SENS{1-4}:CORR:COLL:ECAL:ISOL

Syntax :SENSe{[1]|2|3|4}:CORRection:COLLect:ECAL:ISOLation[:STATe] {ON|OFF|1|0}
:SENSe{[1]|2|3|4}:CORRection:COLLect:ECAL:ISOLation[:STATe]?

Description For channel 1 (:SENS1) to channel 4 (:SENS4), turns ON/OFF the isolation measurement when executing Ecal (Electrical Calibration).

Parameters

	Description
ON or 1	Turns ON the isolation measurement.
OFF or 0 (preset value)	Turns OFF the isolation measurement.

Query response {1|0}<newline><^END>

Example of use

```
10 OUTPUT 717;":SENS1:CORR:COLL:ECAL:ISOL ON"
20 OUTPUT 717;":SENS1:CORR:COLL:ECAL:ISOL?"
30 ENTER 717;A
```

Related commands :SENS{1-4}:CORR:COLL:ECAL:SOLT1 on page 395
:SENS{1-4}:CORR:COLL:ECAL:SOLT2 on page 395

Equivalent key **[Cal] - ECal - Isolation**

:SENS{1-4}:CORR:COLL:ECAL:SOLT1

Syntax :SENSe{[1]|2|3|4}:CORRection:COLLect:ECAL:SOLT1 <numeric>

Description Executes full 1-port calibration of the specified port of channel 1 (:SENS1) to channel 4 (:SENS4) using the ECal (Electrical Calibration) module.

If you execute this command when the ECal module is not connected, an error occurs and the command is ignored. (No query)

Parameters

	<numeric>
Description	Port number
Range	1 to 2
Resolution	1

Example of use

```
10 OUTPUT 717;":SENS1:CORR:COLL:ECAL:SOLT1 1"
20 OUTPUT 717;"*OPC?"
30 ENTER 717;A
```

Equivalent key **[Cal] - ECal - 1-Port Cal - Port 1|Port 2**

:SENS{1-4}:CORR:COLL:ECAL:SOLT2

Syntax :SENSe{[1]|2|3|4}:CORRection:COLLect:ECAL:SOLT2 <numeric 1>,<numeric 2>

Description Executes full 2-port calibration between the 2 specified ports of channel 1 (:SENS1) to channel 4 (:SENS4) using the ECal (Electrical Calibration) module.

If you execute this command when the ECal module is not connected, an error occurs and the command is ignored. (No query)

Parameters

	<numeric 1>	<numeric 2>
Description	Port number	Port number
Range	1 to 2	1 to 2
Resolution	1	1

For each parameter, you must specify a different port number. If you specify the same port number for 2 or more parameters, an error occurs and the command is ignored.

Example of use

```
10 OUTPUT 717;":SENS1:CORR:COLL:ECAL:SOLT2 1,2"
20 OUTPUT 717;"*OPC?"
30 ENTER 717;A
```

Equivalent key **[Cal] - ECal - 2-Port Cal**

:SENS{1-4}:CORR:COLL:ECAL:THRU

Syntax :SENSe{[1]|2|3|4}:CORRection:COLLect:ECAL:THRU <numeric 1>,<numeric 2>

Description Executes response calibration (thru) between the 2 specified ports of channel 1 (:SENS1) to channel 4 (:SENS4) using the ECal (Electrical Calibration) module.

If you execute this command when the ECal module is not connected, an error occurs and the command is ignored. (No query)

Parameters

	<numeric 1>	<numeric 2>
Description	Response port number	Stimulus port number
Range	1 to 2	1 to 2
Resolution	1	1

For each parameter, you must specify a different port number. If you specify the same port number for 2 or more parameters, an error occurs and the command is ignored.

Example of use

```
10 OUTPUT 717;":SENS1:CORR:COLL:ECAL:SOLT2 1,2"  
20 OUTPUT 717;"*OPC?"  
30 ENTER 717;A
```

Equivalent key **[Cal] - ECal - Thru Cal - 2-1 (S21)|1-2 (S12)**

:SENS{1-4}:CORR:COLL:ISOL

Syntax :SENSe{[1]|2|3|4}:CORRection:COLLect[:ACQuire]:ISOLation <numeric 1>,<numeric 2>

Description For channel 1 (:SENS1) to channel 4 (:SENS4), measure the calibration data of the isolation from the stimulus port to the response port. (No query)

Parameters

	<numeric 1>	<numeric 2>
Description	Response port number	Stimulus port number
Range	1 to 2	1 to 2
Resolution	1	1

For each parameter, you must specify a different port number. If you specify the same port number for 2 or more parameters, an error occurs and the command is ignored.

Example of use

```
10 OUTPUT 717;":SENS1:CORR:COLL:ISOL 1,2"
20 OUTPUT 717;"*OPC?"
30 ENTER 717;A
```

Equivalent key **[Cal] - Calibrate - Response (Thru) - Isolation (Optional)**
[Cal] - Calibrate - n-Port Cal - Isolation (Optional) - Port m-n Isol

:SENS{1-4}:CORR:COLL:METH:ERES

Syntax :SENSe{[1]|2|3|4}:CORRection:COLLect:METHod:ERES <numeric 1>,<numeric 2>

Description For channel 1 (:SENS1) to channel 4 (:SENS4), sets the calibration type to the enhanced response calibration. (No query)

Parameters

	<numeric 1>	<numeric 2>
Description	Response port number	Stimulus port number
Range	1 to 2	1 to 2
Resolution	1	1

For each parameter, you must specify a different port number. If you specify the same port number for 2 or more parameters, an error occurs and the command is ignored.

Example of use

```
10 OUTPUT 717;":SENS1:CORR:COLL:METH:ERES 1,2"
```

Related commands

Equivalent key **[Cal] - Calibrate - Enhanced Response - Ports**

:SENS{1-4}:CORR:COLL:LOAD

Syntax :SENSe{[1]|2|3|4}:CORRection:COLLect[:ACQuire]:LOAD <numeric>

Description For channel 1 (:SENS1) to channel 4 (:SENS4), measures the calibration data of the load standard of the specified port. (No query)

Parameters

	<numeric>
Description	Port number
Range	1 to 2
Resolution	1

Example of use

```

10 OUTPUT 717;":SENS1:CORR:COLL:LOAD 1"
20 OUTPUT 717;"*OPC?"
30 ENTER 717;A

```

Equivalent key

- [Cal] - Calibrate - Response (Open)|Response (Short) - Load (Optional)**
- [Cal] - Calibrate - 1-Port Cal - Load**
- [Cal] - Calibrate - n-Port Cal - Reflection - Port m Load**

:SENS{1-4}:CORR:COLL:METH:OPEN

Syntax :SENSe{[1]|2|3|4}:CORRection:COLLect:METhod[:RESPonse]:OPEN <numeric>

Description For channel 1 (:SENS1) to channel 4 (:SENS4), sets the calibration type to the response calibration (open) of the specified port. (No query)

Parameters

	<numeric>
Description	Port number
Range	1 to 2
Resolution	1

Example of use 10 OUTPUT 717; ":SENS1:CORR:COLL:METH:OPEN 1"

Related commands :SENS{1-4}:CORR:COLL:METH:TYPE? on page 403

Equivalent key **[Cal] - Calibrate - Response (Open) - Port**

:SENS{1-4}:CORR:COLL:METH:SHOR

Syntax :SENSe{[1]|2|3|4}:CORRection:COLLect:METhod[:RESPonse]:SHORT <numeric>

Description For channel 1 (:SENS1) to channel 4 (:SENS4), sets the calibration type to the response calibration (short) of the specified port. (No query)

Parameters

	<numeric>
Description	Port number
Range	1 to 2
Resolution	1

Example of use 10 OUTPUT 717; ":SENS1:CORR:COLL:METH:SHOR 1"

Related commands :SENS{1-4}:CORR:COLL:METH:TYPE? on page 403

Equivalent key **[Cal] - Calibrate - Response (Short) - Port**

:SENS{1-4}:CORR:COLL:METH:SOLT1

Syntax :SENSe{[1]2|3|4}:CORRection:COLLect:METhod:SOLT1 <numeric>

Description For channel 1 (:SENS1) to channel 4 (:SENS4), sets the calibration type to the full 1-port calibration of the specified port. (No query)

Parameters

	<numeric>
Description	Port number
Range	1 to 2
Resolution	1

Example of use 10 OUTPUT 717;":SENS1:CORR:COLL:METH:SOLT1 1"

Related commands :SENS{1-4}:CORR:COLL:METH:TYPE? on page 403

Equivalent key **[Cal] - Calibrate - 1-Port Cal - Port**

:SENS{1-4}:CORR:COLL:METH:SOLT2

Syntax :SENSe{[1]2|3|4}:CORRection:COLLect:METhod:SOLT2 <numeric 1>,<numeric 2>

Description For channel 1 (:SENS1) to channel 4 (:SENS4), sets the calibration type to the full 2-port calibration between the 2 specified ports. (No query)

Parameters

	<numeric 1>	<numeric 2>
Description	Port number	Port number
Range	1 to 2	1 to 2
Resolution	1	1

For each parameter, you must specify a different port number. If you specify the same port number for 2 or more parameters, an error occurs and the command is ignored.

Example of use 10 OUTPUT 717;":SENS1:CORR:COLL:METH:SOLT2 1,2"

Related commands :SENS{1-4}:CORR:COLL:METH:TYPE? on page 403

Equivalent key **[Cal] - Calibrate - 2-Port Cal - Ports**

:SENS{1-4}:CORR:COLL:METH:THRU

Syntax :SENSe{[1]|2|3|4}:CORRection:COLLect:METhod[:RESPonse]:THRU <numeric 1>,<numeric 2>

Description For channel 1 (:SENS1) to channel 4 (:SENS4), sets the calibration type to the response calibration (thru) between the 2 specified ports. (No query)

Parameters

	<numeric 1>	<numeric 2>
Description	Port number	Port number
Range	1 to 2	1 to 2
Resolution	1	1

For each parameter, you must specify a different port number. If you specify the same port number for 2 or more parameters, an error occurs and the command is ignored.

Example of use 10 OUTPUT 717;":SENS1:CORR:COLL:METH:THRU 1,2"

Related commands :SENS{1-4}:CORR:COLL:METH:TYPE? on page 403

Equivalent key **[Cal] - Calibrate - Response (Thru) - Ports**

:SENS{1-4}:CORR:COLL:METH:TYPE?

Syntax :SENSe{[1]|2|3|4}:CORRection:COLLect:METhod:TYPE?

Description For channel 1 (:SENS1) to channel 4 (:SENS4), reads out the calibration type selected for calculation of the calibration coefficients. (Query only)

Query response {ERES|NONE|RESPO|RESPTS|RESPT|SOLT1|SOLT2}<newline><^END>

	Description
ERES	The calibration type is the enhanced response calibration.
NONE	The calibration type is set to nothing.
RESPO	The calibration type is the response calibration (open).
RESPTS	The calibration type is the response calibration (short).
RESPT	The calibration type is the response calibration (thru).
SOLT1	The calibration type is the full 1-port calibration.
SOLT2	The calibration type is the full 2-port calibration.

Example of use

```
10 OUTPUT 717;":SENS1:CORR:COLL:METH:TYPE?"
20 ENTER 717;A$
```

Equivalent key No equivalent key is available on the front panel.

:SENS{1-4}:CORR:COLL:OPEN

Syntax :SENSe{[1]|2|3|4}:CORRection:COLLect[:ACQuire]:OPEN <numeric>

Description For channel 1 (:SENS1) to channel 4 (:SENS4), measures the calibration data of the open standard of the specified port. (No query)

Parameters

	<numeric>
Description	Port number
Range	1 to 2
Resolution	1

Example of use

```
10 OUTPUT 717; ":SENS1:CORR:COLL:OPEN 1"  
20 OUTPUT 717; "*OPC?"  
30 ENTER 717;A
```

Equivalent key **[Cal] - Calibrate - Response (Open)|1-Port Cal - Open**
[Cal] - Calibrate - n-Port Cal - Reflection - Port m Open

:SENS{1-4}:CORR:COLL:SAVE

- Syntax** :SENSe{[1]2|3|4}:CORRection:COLLect:SAVE
- Description** From the measured calibration data, calculates the calibration coefficients depending on the selected calibration type.
- Calculating the calibration coefficients clears all calibration data whether or not used for the calculation and also clears the calibration type selections.
- If you execute this command before all necessary calibration data for calculating the calibration coefficients is measured, an error occurs and the command is ignored. (No query)
- Example of use** 10 OUTPUT 717;":SENS1:CORR:COLL:SAVE"
- Related commands** :SENS{1-4}:CORR:COLL:METH:OPEN on page 400
:SENS{1-4}:CORR:COLL:METH:SHOR on page 400
:SENS{1-4}:CORR:COLL:METH:THRU on page 402
:SENS{1-4}:CORR:COLL:METH:SOLT1 on page 401
:SENS{1-4}:CORR:COLL:METH:SOLT2 on page 401
- Equivalent key** **[Cal] - Calibrate - Response|n-Port Cal - Done**

:SENS{1-4}:CORR:COLL:SHOR

- Syntax** :SENSe{[1]2|3|4}:CORRection:COLLect[:ACQuire]:SHORT <numeric>
- Description** For channel 1 (:SENS1) to channel 4 (:SENS4), measures the calibration data of the short standard of the specified port. (No query)
- Parameters**

	<numeric>
Description	Port number
Range	1 to 2
Resolution	1

- Example of use** 10 OUTPUT 717;":SENS1:CORR:COLL:SHOR 1"
20 OUTPUT 717;"*OPC?"
30 ENTER 717;A
- Equivalent key** **[Cal] - Calibrate - Response (Short)|1-Port Cal - Short**
[Cal] - Calibrate - n-Port Cal - Reflection - Port m Short

:SENS{1-4}:CORR:COLL:THRU

Syntax :SENSe{[1]|2|3|4}:CORRection:COLLect[:ACQuire]:THRU <numeric 1>,<numeric 2>

Description For channel 1 (:SENS1) to channel 4 (:SENS4), measure the calibration data of the thru standard from the stimulus port to the response port. (No query)

Parameters

	<numeric 1>	<numeric 2>
Description	Response port number	Stimulus port number
Range	1 to 2	1 to 2
Resolution	1	1

For each parameter, you must specify a different port number. If you specify the same port number for 2 or more parameters, an error occurs and the command is ignored.

Example of use

```

10  OUTPUT 717;":SENS1:CORR:COLL:THRU 1,2"
20  OUTPUT 717;"*OPC?"
30  ENTER 717;A

```

Equivalent key **[Cal] - Calibrate - Response (Thru) - Thru**
[Cal] - Calibrate - n-Port Cal - Transmission - Port m-n Thru

:SENS{1-4}:CORR:EXT

Syntax :SENSe{[1]2|3|4}:CORRection:EXTension[:STATe] {ON|OFF|1|0}
:SENSe{[1]2|3|4}:CORRection:EXTension[:STATe]?

Description For channel 1 (:SENS1) to channel 4 (:SENS4), turns ON/OFF the port extension.

Parameters

	Description
ON or 1	Turns ON the port extension.
OFF or 0 (preset value)	Turns OFF the port extension.

Query response {1|0}<newline><^END>

Example of use
10 OUTPUT 717;":SENS1:CORR:EXT ON"
20 OUTPUT 717;":SENS1:CORR:EXT?"
30 ENTER 717;A

Related commands :SENS{1-4}:CORR:EXT:PORT{1-2} on page 408

Equivalent key **[Cal] - Port Extensions - Extensions**

:SENS{1-4}:CORR:EXT:PORT{1-2}

Syntax :SENSe{[1]|2|3|4}:CORRection:EXTension:PORT {[1]|2} <numeric>
 :SENSe{[1]|2|3|4}:CORRection:EXTension:PORT {[1]|2}?

Description For channel 1 (:SENS1) to channel 4 (:SENS4), sets the correction amount for the port extension of port 1 (:PORT1) to port 2 (:PORT2) as the delay time.

Parameters

	<numeric>
Description	Delay time
Range	-10 to 10
Preset value	0
Unit	s (second)

If the specified parameter is out of the allowable setup range, the minimum value (if the lower limit of the range is not reached) or the maximum value (if the upper limit of the range is exceeded) is set.

Query response {numeric}<newline><^END>

Example of use
 10 OUTPUT 717; ":SENS1:CORR:EXT:PORT1 1E-3"
 20 OUTPUT 717; ":SENS1:CORR:EXT?"
 30 ENTER 717;A

Related commands :SENS{1-4}:CORR:EXT on page 407

Equivalent key **[Cal] - Port Extensions - Extension Port 1|Extension Port 2**

:SENS{1-4}:CORR:PROP

Syntax
:SENSe{[1]2[3]4}:CORRection:PROPeRty {ON|OFF|1|0}
:SENSe{[1]2[3]4}:CORRection:PROPeRty?

Description
Turns ON/OFF the display of the calibration property of channel 1 (:SENS1) to channel 4 (:SENS4).

Parameters

	Description
ON or 1	Turns ON the calibration property display.
OFF or 0 (preset value)	Turns OFF the calibration property display.

Query response
{1|0}<newline><^END>

Example of use
10 OUTPUT 717;":SENS1:CORR:PROP ON"
20 OUTPUT 717;":SENS1:CORR:PROP?"
30 ENTER 717;A

Equivalent key
[Cal] - Property

:SENS{1-4}:CORR:RVEL:COAX

Syntax
:SENSe{[1]2[3]4}:CORRection:RVELocity:COAX <numeric>
:SENSe{[1]2[3]4}:CORRection:RVELocity:COAX?

Description
For channel 1 (:SENS1) to channel 4 (:SENS4), sets the velocity factor.

Parameters

	<numeric>
Description	Velocity factor
Range	0.01 to 10
Preset value	1

If the specified parameter is out of the allowable setup range, the minimum value (if the lower limit of the range is not reached) or the maximum value (if the upper limit of the range is exceeded) is set.

Query response
{numeric}<newline><^END>

Example of use
10 OUTPUT 717;":SENS1:CORR:RVEL:COAX 0.7"
20 OUTPUT 717;":SENS1:CORR:RVEL:COAX?"
30 ENTER 717;A

Equivalent key
[Cal] - Velocity Factor

:SENS{1-4}:CORR:STAT

Syntax :SENSe{[1]|2|3|4}:CORRection:STATe {ON|OFF|1|0}
:SENSe{[1]|2|3|4}:CORRection:STATe?

Description For channel 1 (:SENS1) to channel 4 (:SENS4), turns ON/OFF the error correction.

Parameters

	Description
ON or 1	Turns ON the error correction.
OFF or 0 (preset value)	Turns OFF the error correction.

Query response {1|0}<newline><^END>

Example of use
10 OUTPUT 717;":SENS1:CORR:STAT ON"
20 OUTPUT 717;":SENS1:CORR:STAT?"
30 ENTER 717;A

Equivalent key **[Cal] - Correction**

:SENS{1-4}:CORR:TYPE{1-4}?

Syntax :SENSe{[1]|2|3|4}:CORRection:TYPE{[1]|2|3|4}?

Description For trace 1 (:TYPE1) to trace 4 (:TYPE4) of channel 1 (:SENS1) to channel 4 (:SENS4), reads out the information (calibration type, port numbers) of the applied calibration coefficients for the actual error correction.

Query response {ERES|NONE|RESPO|RESPTS|RESPT|SOLT1|SOLT2},{numeric 1},{numeric 2}<newline><^END>

{ERES|NONE|RESPO|RESPTS|RESPT|SOLT1|SOLT2}:

	Description
ERES	The enhanced response calibration is applied.
NONE	Any calibration is not applied.
RESPO	The response calibration (open) is applied.
RESPTS	The response calibration (short) is applied.
RESPT	The response calibration (thru) is applied.
SOLT1	The full 1-port calibration is applied.
SOLT2	The full 2-port calibration is applied.

{numeric 1}: the calibration port number
(This parameter is 0 when the first parameter is NONE.)

{numeric 2}: the calibration port number
(This parameter is 0 when the first parameter is not ERES, RESPT and SOLT2.)

Example of use

```
10 OUTPUT 717;":SENS1:CORR:TYPE1?"
20 ENTER 717;A$
```

Equivalent key No equivalent key is available on the front panel.

:SENS{1-4}:FREQ

Syntax :SENSe{[1]|2|3|4}:FREQuency[:CW|FIXed] <numeric>
 :SENSe{[1]|2|3|4}:FREQuency[:CW|FIXed]?

Description Sets the fixed frequency (CW frequency) for the power sweep for channel 1 (:SENS1) to channel 4 (:SENS4).

Parameters

	<numeric>
Description	Fixed frequency
Range	3E5 to 3E9
Preset value	3E5
Unit	Hz (hertz)
Resolution	1

If the specified parameter is out of the allowable setup range, the minimum value (if the lower limit of the range is not reached) or the maximum value (if the upper limit of the range is exceeded) is set.

Query response {numeric}<newline><^END>

Example of use
 10 OUTPUT 717;":SENS1:FREQ 1E9"
 20 OUTPUT 717;":SENS1:FREQ?"
 30 ENTER 717;A

Related commands :SENS{1-4}:SWE:TYPE on page 426

Equivalent key **[Sweep Setup] - Power - CW Freq**

:SENS{1-4}:FREQ:CENT

Syntax :SENSe{[1]|2|3|4}:FREQuency:CENTer <numeric>
:SENSe{[1]|2|3|4}:FREQuency:CENTer?

Description Sets the center value of the sweep range of channel 1 (:SENS1) to channel 4 (:SENS4).

Parameters

	<numeric>
Description	Center value
Range	3E5 to 3E9
Preset value	4.25015E9
Unit	Hz (hertz)
Resolution	0.5 or 1

If the specified parameter is out of the allowable setup range, the minimum value (if the lower limit of the range is not reached) or the maximum value (if the upper limit of the range is exceeded) is set.

Query response {numeric}<newline><^END>

Example of use
10 OUTPUT 717;":SENS1:FREQ:CENT 2E9"
20 OUTPUT 717;":SENS1:FREQ:CENT?"
30 ENTER 717;A

Related commands :SENS{1-4}:FREQ:SPAN on page 415

Equivalent key **[Center]**

:SENS{1-4}:FREQ:DATA?

Syntax :SENSe{[1]|2|3|4}:FREQuency:DATA?

Description For channel 1 (:SENS1) to channel 4 (:SENS4), reads out the frequencies of all measurement point.

The data transfer format when this command is executed depends on the setting with the :FORM:DATA command. (Query only)

Query response {numeric 1},...,{numeric NOP}<newline><^END>

	Description
{numeric n}	Frequency at the n-th measurement point

Where NOP is the number of measurement points and n is an integer between 1 and NOP.

Example of use

```
10 DIM A(1:201)
20 OUTPUT 717;" :SENS1:FREQ:DATA?"
30 ENTER 717;A(*)
```

Related commands :FORM:DATA on page 336

Equivalent key No equivalent key is available on the front panel.

:SENS{1-4}:FREQ:SPAN

Syntax :SENSe{[1]2|3|4}:FREQuency:SPAN <numeric>
:SENSe{[1]2|3|4}:FREQuency:SPAN?

Description Sets the span value of the sweep range of channel 1 (:SENS1) to channel 4 (:SENS4).

Parameters

	<numeric>
Description	Span value
Range	0 to 2.9997E9
Preset value	2.9997E9
Unit	Hz (hertz)
Resolution	1

If the specified parameter is out of the allowable setup range, the minimum value (if the lower limit of the range is not reached) or the maximum value (if the upper limit of the range is exceeded) is set.

Query response {numeric}<newline><^END>

Example of use
10 OUTPUT 717;":SENS1:FREQ:SPAN 1E9"
20 OUTPUT 717;":SENS1:FREQ:SPAN?"
30 ENTER 717;A

Related commands :SENS{1-4}:FREQ:CENT on page 413

Equivalent key **[Span]**

:SENS{1-4}:FREQ:STAR

Syntax :SENSe{[1]|2|3|4}:FREQuency:STARt <numeric>
:SENSe{[1]|2|3|4}:FREQuency:STARt?

Description Sets the start value of the sweep range of channel 1 (:SENS1) to channel 4 (:SENS4).

Parameters

	<numeric>
Description	Start value
Range	3E5 to 3E9
Preset value	3E5
Unit	Hz (hertz)
Resolution	1

If the specified parameter is out of the allowable setup range, the minimum value (if the lower limit of the range is not reached) or the maximum value (if the upper limit of the range is exceeded) is set.

Query response {numeric}<newline><^END>

Example of use
10 OUTPUT 717;":SENS1:FREQ:STAR 100E6"
20 OUTPUT 717;":SENS1:FREQ:STAR?"
30 ENTER 717;A

Related commands :SENS{1-4}:FREQ:STOP on page 417

Equivalent key **[Start]**

:SENS{1-4}:FREQ:STOP

Syntax :SENSe{[1]2|3|4}:FREQuency:STOP <numeric>
:SENSe{[1]2|3|4}:FREQuency:STOP?

Description Sets the stop value of the sweep range of channel 1 (:SENS1) to channel 4 (:SENS4).

Parameters

	<numeric>
Description	Stop value
Range	3E5 to 3E9
Preset value	3E9
Unit	Hz (hertz)
Resolution	1

If the specified parameter is out of the allowable setup range, the minimum value (if the lower limit of the range is not reached) or the maximum value (if the upper limit of the range is exceeded) is set.

Query response {numeric}<newline><^END>

Example of use

```

10 OUTPUT 717;":SENS1:FREQ:STOP 100E6"
20 OUTPUT 717;":SENS1:FREQ:STOP?"
30 ENTER 717;A

```

Related commands :SENS{1-4}:FREQ:STAR on page 416

Equivalent key **[Stop]**

:SENS{1-4}:ROSC:SOUR?

Syntax :SENSe{[1]|2|3|4}:ROSCillator:SOURce?

Description Reads out whether the external reference signal is inputted to the Ref In connector on the rear panel. (Query only)

Query response {INTernal|EXTernal}<newline><^END>

	Description
INTernal	The external reference signal is not inputted.
EXTernal	The external reference signal is inputted.

Example of use
10 OUTPUT 717;":SENS1:ROSC:SOUR?"
20 ENTER 717;A\$

Equivalent key Displayed on the instrument status bar (at the bottom of the LCD display).

:SENS{1-4}:SEGM:DATA

- Syntax** :SENSe{[1]2|3|4}:SEGMent:DATA 5,<mode>,<ifbw>,<pow>,,<time>,<segm>,<star 1>,<stop 1>,<nop 1>,<ifbw 1>,<pow 1>,<del 1>,<time 1>,...,<star n>,<stop n>,<nop n>,<ifbw n>,<pow n>,<del n>,<time n>,...,<star N>,<stop N>,<nop N>,<ifbw N>,<pow N>,<del N>,<time N>
- :SENSe{[1]2|3|4}:SEGMent:DATA?
- Where N is the number of segments (specified with <segm>) and n is an integer between 1 and N.
- Description** Creates the segment sweep table for channel 1 (:SENS1) to channel 4 (:SENS4).
The data transfer format when this command is executed depends on the setting with the :FORM:DATA command.
- Parameters** The first value is 5 and the parameters listed below follow.

	Description
<mode>	Stimulus setting mode 0: Specifies with start/stop values 1: Specifies with center/span values
<ifbw>	ON/OFF of the IF bandwidth setting for each segment 0: Off, 1: On
<pow>	ON/OFF of the power setting for each segment 0: Off, 1: On
	ON/OFF of the sweep delay time setting for each segment 0: Off, 1: On
<time>	ON/OFF of the sweep time setting for each segment 0: Off, 1: On
<segm>	Number of segments (1 to 201)
<star n>	Start value/center value of the n-th segment
<stop n>	Stop value/span value of the n-th segment
<nop n>	Number of measurement points of the n-th segment
<ifbw n>	IF bandwidth of the n-th segment Not required when the IF bandwidth setting for each segment is OFF (<ifbw> = 0)
<pow n>	Power of the n-th segment Not required when the power setting for each segment is OFF (<pow> = 0)
<del n>	Sweep delay time of the n-th segment Not required when the sweep delay time setting for each segment is OFF (= 0)

	Description
<time n>	Sweep time of the n-th segment (specify 0 If you want to set “auto setting”) Not required when the sweep time setting for each segment is OFF (<time> = 0)

Query response 5, {mode}, {ifbw}, {pow}, {del}, {time}, {segm},
 {star 1}, {stop 1}, {nop 1}, {pow 1}, {del 1}, {time 1}, ...,
 {star n}, {stop n}, {nop n}, {pow n}, {del n}, {time n}, ...,
 {star N}, {stop N}, {nop N}, {pow N}, {del N}, {time N} <newline> <^END>

Example of use 10 DIM H(1:3,1:4)
 20 OUTPUT 717; ":SENS1:SEGM:DATA 5,0,1,0,0,0,3,";
 30 OUTPUT 717; "1E9,3E9,11,70e3,";
 40 OUTPUT 717; "3E9,4E9,51,7e3,";
 50 OUTPUT 717; "4E9,6E9,11,70e3"
 60 OUTPUT 717; ":SENS1:SEGM:DATA?"
 70 ENTER 717;A,B,C,D,E,F,G,H(*)

Related commands :SENS{1-4}:SWE:TYPE on page 426
 :FORM:DATA on page 336

Equivalent key **[Sweep Setup] - Edit Segment Table**

:SENS{1-4}:SEGM:SWE:POIN?

Syntax	:SENSe{[1]2 3 4}:SEGMent:SWEep:POINts?
Description	For the segment sweep table of channel 1 (:SENS1) to channel 4 (:SENS4), reads out the total number of the measurement points of all segments. (Query only)
Query response	{numeric}<newline><^END>
Example of use	10 OUTPUT 717;":SENS1:SEGM:SWE:POIN?" 20 ENTER 717;A
Related commands	:SENS{1-4}:SEGM:DATA on page 419
Equivalent key	No equivalent key is available on the front panel.

:SENS{1-4}:SEGM:SWE:TIME?

Syntax	:SENSe{[1]2 3 4}:SEGMent:SWEep:TIME?
Description	For the segment sweep table of channel 1 (:SENS1) to channel 4 (:SENS4), reads out the total sweep time of all segments. (Query only)
Query response	{numeric}<newline><^END>
Example of use	10 OUTPUT 717;":SENS1:SEGM:SWE:TIME?" 20 ENTER 717;A
Related commands	:SENS{1-4}:SEGM:DATA on page 419
Equivalent key	No equivalent key is available on the front panel.

:SENS{1-4}:SWE:DEL

Syntax :SENSe{[1]|2|3|4}:SWEp:DELay <numeric>
:SENSe{[1]|2|3|4}:SWEp:DELay?

Description Sets the sweep delay time of channel 1 (:SENS1) to channel 4 (:SENS4).

Parameters

	<numeric>
Description	Sweep delay time
Range	0 to 1
Preset value	0
Unit	s (second)
Resolution	0.001

If the specified parameter is out of the allowable setup range, the minimum value (if the lower limit of the range is not reached) or the maximum value (if the upper limit of the range is exceeded) is set.

Query response {numeric}<newline><^END>

Example of use
10 OUTPUT 717;":SENS1:SWE:DEL 0.05"
20 OUTPUT 717;":SENS1:SWE:DEL?"
30 ENTER 717;A

Equivalent key **[Sweep Setup] - Sweep Delay**

:SENS{1-4}:SWE:POIN

Syntax :SENSe{[1]2|3|4}:SWEp:POINts <numeric>
:SENSe{[1]2|3|4}:SWEp:POINts?

Description Sets the number of measurement points of channel 1 (:SENS1) to channel 4 (:SENS4).

Parameters

	<numeric>
Description	Number of measurement points
Range	2 to 1601
Preset value	201
Resolution	1

If the specified parameter is out of the allowable setup range, the minimum value (if the lower limit of the range is not reached) or the maximum value (if the upper limit of the range is exceeded) is set.

Query response {numeric}<newline><^END>

Example of use
10 OUTPUT 717;":SENS1:SWE:POIN 801"
20 OUTPUT 717;":SENS1:SWE:POIN?"
30 ENTER 717;A

Equivalent key **[Sweep Setup] - Points**

:SENS{1-4}:SWE:TIME

Syntax :SENSe{[1]|2|3|4}:SWEp:TIME[:DATA] <numeric>
:SENSe{[1]|2|3|4}:SWEp:TIME[:DATA]?

Description Sets the sweep time of channel 1 (:SENS1) to channel 4 (:SENS4).

When the auto setting of the sweep time is ON, even if you try to set the sweep time to any value with this command, it automatically returns to the value defined by the E5061A/E5062A. Before using this command, turns OFF the auto setting of the sweep time (specify OFF with the :SENS{1-4}:SWE:TIME:AUTO command).

Parameters

	<numeric>
Description	Sweep time
Range	Varies depending on the measurement conditions.
Preset value	Varies depending on the measurement conditions.
Unit	s (second)

If the specified parameter is out of the allowable setup range, the minimum value (if the lower limit of the range is not reached) or the maximum value (if the upper limit of the range is exceeded) is set.

Query response {numeric}<newline><^END>

Example of use

```
10  OUTPUT 717;":SENS1:SWE:TIME 1.5"
20  OUTPUT 717;":SENS1:SWE:TIME?"
30  ENTER 717;A
```

Related commands :SENS{1-4}:SWE:TIME:AUTO on page 425

Equivalent key **[Sweep Setup] - Sweep Time**

:SENS{1-4}:SWE:TIME:AUTO

Syntax :SENSe{[1]2|3|4}:SWEp:TIME:AUTO {ON|OFF|1|0}
:SENSe{[1]2|3|4}:SWEp:TIME:AUTO?

Description Sets whether to automatically set the sweep time of channel 1 (:SENS1) to channel 4 (:SENS4).

Parameters

	Description
ON or 1 (preset value)	Turns ON the auto setting.
OFF or 0	Turns OFF the auto setting.

Query response {1|0}<newline><^END>

Example of use
10 OUTPUT 717;":SENS1:SWE:TIME:AUTO ON"
20 OUTPUT 717;":SENS1:SWE:TIME:AUTO?"
30 ENTER 717;A

Related commands :SENS{1-4}:SWE:TIME on page 424

Equivalent key **[Sweep Setup] - Sweep Time**

:SENS{1-4}:SWE:TYPE

Syntax :SENSe{[1]|2|3|4}:SWEep:TYPE {LINear|LOGarithmic|SEGMENT|POWer}
:SENSe{[1]|2|3|4}:SWEep:TYPE?

Description Sets the sweep type of channel 1 (:SENS1) to channel 4 (:SENS4).

Parameters

	Description
LINear (preset value)	Specifies the linear sweep.
LOGarithmic	Specifies the logarithmic sweep. *1
SEGMENT	Specifies the segment sweep.
POWer	Specifies the power sweep.

*1. If you execute this command to try to specify the log sweep when the frequency span condition necessary for the log sweep is not satisfied (the stop frequency is about 4 times or more the start frequency), an error occurs and the command is ignored.

Query response {LIN|LOG|SEG|POW}<newline><^END>

Example of use
10 OUTPUT 717; ":SENS1:SWE:TYPE SEGM"
20 OUTPUT 717; ":SENS1:SWE:TYPE?"
30 ENTER 717;A\$

Equivalent key **[Sweep Setup] - Sweep Type - Lin Freq|Log Freq|Segment**

:SERV:CHAN:ACT?

Syntax :SERVice:CHANnel:ACTive?

Description Reads out the active channel number. (Query only)

Query response {numeric}<newline><^END>

Example of use
10 OUTPUT 717; ":SERV:CHAN:ACT?"
20 ENTER 717;A

Related commands :DISP:WIND{1-4}:ACT on page 316

Equivalent key No equivalent key is available on the front panel.

:SERV:CHAN:COUN?

Syntax	:SERVice:CHANnel:COUNT?
Description	Reads out the upper limit of the number of channels of the E5061A/E5062A. (Query only)
Query response	{numeric}<newline><^END>
Example of use	10 OUTPUT 717;":SERV:CHAN:COUN?" 20 ENTER 717;A
Equivalent key	No equivalent key is available on the front panel.

:SERV:CHAN{1-4}:TRAC:ACT?

Syntax	:SERVice:CHANnel{[1] 2 3 4}:TRACe:ACTive?
Description	Reads out the active trace number of channel 1 (:CHAN1) to channel 4 (:CHAN4). (Query only)
Query response	{numeric}<newline><^END>
Example of use	10 OUTPUT 717;":SERV:CHAN1:TRAC:ACT?" 20 ENTER 717;A
Related commands	:CALC{1-4}:PAR{1-4}:SEL on page 284
Equivalent key	No equivalent key is available on the front panel.

:SERV:CHAN:TRAC:COUN?

Syntax	:SERVice:CHANnel:TRACe:COUNt?
Description	Reads out the upper limit of the number of traces per channel. (Query only)
Query response	{numeric}<newline><^END>
Example of use	10 OUTPUT 717;":SERV:CHAN:TRAC:COUN?" 20 ENTER 717;A
Equivalent key	No equivalent key is available on the front panel.

:SERV:PORT:COUN?

Syntax	:SERVice:PORT:COUNT?
Description	Reads out the number of ports of the E5061A/E5062A. (Query only)
Query response	{numeric}<newline><^END>
Example of use	10 OUTPUT 717; ":SERV:PORT:COUN?" 20 ENTER 717;A
Equivalent key	No equivalent key is available on the front panel.

:SOUR{1-4}:POW

Syntax :SOURce{[1]|2|3|4}:POWer[:LEVel][:IMMediate]
[:AMPLitude] <numeric>
:SOURce{[1]|2|3|4}:POWer[:LEVel][:IMMediate]
[:AMPLitude]?

Description Sets the power level of channel 1 (:SOUR1) to channel 4 (:SOUR4).

Parameters

	<numeric>
Description	Power level
Range	Varies depending on the power range.
Preset value	0
Unit	dBm
Resolution	0.05

If the specified parameter is out of the allowable setup range, the minimum value (if the lower limit of the range is not reached) or the maximum value (if the upper limit of the range is exceeded) is set.

Query response {numeric}<newline><^END>

Example of use
10 OUTPUT 717;":SOUR1:POW -12.5"
20 OUTPUT 717;":SOUR1:POW?"
30 ENTER 717;A

Related commands :SOUR{1-4}:POW:ATT on page 430

Equivalent key **[Sweep Setup] - Power**

:SOUR{1-4}:POW:ATT

Syntax :SOURce{[1]|2|3|4}:POWer:ATTenuation[:DATA] <numeric>
:SOURce{[1]|2|3|4}:POWer:ATTenuation[:DATA]?

Description Sets the power range of channel 1 (:SOUR1) to channel 4 (:SOUR4).
The power range is selected depending on the setting of the attenuator. The following table shows the relationship between the attenuator value and the power range.

Attenuator	Power range	Attenuator	Power range
0 dB	-5 to +10 dBm	30 dB	-35 to -20 dBm
10 dB	-15 to 0 dBm	40 dB	-45 to -30 dBm
20 dB	-25 to -10 dBm		

If you execute this command when the power range extension function is not installed, an error occurs and the command is ignored.

Parameters

	<numeric>
Description	Attenuator value
Range	0 to 40
Preset value	0
Unit	dB
Resolution	10

If the specified parameter is out of the allowable setup range, the minimum value (if the lower limit of the range is not reached) or the maximum value (if the upper limit of the range is exceeded) is set.

Query response {numeric}<newline><^END>

Example of use
10 OUTPUT 717;":SOUR1:POW:ATT 10"
20 OUTPUT 717;":SOUR1:POW:ATT?"
30 ENTER 717;A

Related commands :SOUR{1-4}:POW on page 429

Equivalent key [Sweep Setup] - Power - Power Ranges

:SOUR{1-4}:POW:CENT

Syntax :SOURce{[1]|2|3|4}:POWer:CENTer <numeric>
:SOURce{[1]|2|3|4}:POWer:CENTer?

Description Sets the center value of the sweep range for the power sweep for channel 1 (:SOUR1) to channel 4 (:SOUR4).

Parameters

	<numeric>
Description	Center value
Range	Varies depending on the power range.
Preset value	-2.5
Unit	dBm
Resolution	0.05 or 0.025

If the specified parameter is out of the allowable setup range, the minimum value (if the lower limit of the range is not reached) or the maximum value (if the upper limit of the range is exceeded) is set.

Query response {numeric}<newline><^END>

Example of use
10 OUTPUT 717;":SOUR1:POW:CENT 0"
20 OUTPUT 717;":SOUR1:POW:CENT?"
30 ENTER 717;A

Related commands :SENS{1-4}:SWE:TYPE on page 426
:SOUR{1-4}:POW:ATT on page 430
:SOUR{1-4}:POW:SPAN on page 436

Equivalent key **[Center]**

:SOUR{1-4}:POW:PORT:COUP

Syntax :SOURce{[1]|2|3|4}:POWer:PORT:COUPle {ON|OFF|1|0}
:SOURce{[1]|2|3|4}:POWer:PORT:COUPle?

Description Sets whether to output the same power level for each port of channel 1 (:SOUR1) to channel 4 (:SOUR4). When the power slope feature is on (ON specified with the :SOUR{1-4}:POW:SLOP:STAT command), the same power level is always outputted to all ports regardless of this setting because different power levels cannot be outputted for each port.

Parameters

	Description
ON or 1 (preset value)	Outputs the same power level to individual ports.
OFF or 0	Outputs different power levels to individual ports.

Query response {1|0}<newline><^END>

Example of use
10 OUTPUT 717;":SOUR1:POW:PORT:COUP OFF"
20 OUTPUT 717;":SOUR1:POW:PORT:COUP?"
30 ENTER 717;A

Related commands :SOUR{1-4}:POW:PORT{1-2} on page 433

Equivalent key **[Sweep Setup] - Power - Port Couple**

:SOUR{1-4}:POW:PORT{1-2}

Syntax :SOURce{[1]|2|3|4}:POWer:PORT{[1]|2}[:LEVel][:IMMediate][:AMPLitude] <numeric>
:SOURce{[1]|2|3|4}:POWer:PORT{[1]|2}[:LEVel][:IMMediate][:AMPLitude]?

Description Sets the power level of port 1 (:PORT1) to port 2 (:PORT2) of channel 1 (:SOUR1) to channel 4 (:SOUR4).

Parameters

	<numeric>
Description	The power level at the specified port.
Range	Varies depending on the power range.
Preset value	0
Unit	dBm
Resolution	0.05

If the specified parameter is out of the allowable setup range, the minimum value (if the lower limit of the range is not reached) or the maximum value (if the upper limit of the range is exceeded) is set.

Query response {numeric}<newline><^END>

Example of use
10 OUTPUT 717;":SOUR1:POW:PORT1 -12.5"
20 OUTPUT 717;":SOUR1:POW:PORT1?"
30 ENTER 717;A

Related commands :SOUR{1-4}:POW:PORT:COUP on page 432
:SOUR{1-4}:POW:ATT on page 430

Equivalent key **[Sweep Setup] - Power - Port Power - Port 1 Power|Port 2 Power**

:SOUR{1-4}:POW:SLOP

Syntax :SOURce{[1]2|3|4}:POWer[:LEVel]:SLOPe[:DATA] <numeric>
:SOURce{[1]2|3|4}:POWer[:LEVel]:SLOPe[:DATA]?

Description Sets the correction value of the power slope feature of channel 1 (:SOUR1) to channel 4 (:SOUR4).

Parameters

	<numeric>
Description	The correction value of the power slope feature
Range	-2 to 2
Preset value	0
Unit	dB/GHz
Resolution	0.01

If the specified parameter is out of the allowable setup range, the minimum value (if the lower limit of the range is not reached) or the maximum value (if the upper limit of the range is exceeded) is set.

Query response {numeric}<newline><^END>

Example of use
10 OUTPUT 717;":SOUR1:POW:SLOP 0.1"
20 OUTPUT 717;":SOUR1:POW:SLOP?"
30 ENTER 717;A

Related commands :SOUR{1-4}:POW:SLOP:STAT on page 435

Equivalent key **[Sweep Setup] - Power - Slope [xxx dB/GHz]**

:SOUR{1-4}:POW:SLOP:STAT

Syntax :SOURce{[1]|2|3|4}:POWer[:LEVel]:SLOPe:STATe {ON|OFF|1|0}
:SOURce{[1]|2|3|4}:POWer[:LEVel]:SLOPe:STATe?

Description Turns on/off the power slope feature of channel 1 (:SOUR1) to channel 4 (:SOUR4). This function is a function to correct the attenuation of simple power level proportional to the frequency (attenuation due to cables and so on).

Parameters

	Description
ON or 1	Turns on the power slope feature.
OFF or 0 (preset value)	Turns off the power slope feature.

Query response {1|0}<newline><^END>

Example of use
10 OUTPUT 717;":SOUR1:POW:SLOP:STAT ON"
20 OUTPUT 717;":SOUR1:POW:SLOP:STAT?"
30 ENTER 717;A

Related commands :SOUR{1-4}:POW:SLOP on page 434

Equivalent key **[Sweep Setup] - Power - Slop [ON/OFF]**

:SOUR{1-4}:POW:SPAN

Syntax :SOURce{[1]|2|3|4}:POWer:SPAN <numeric>
 :SOURce{[1]|2|3|4}:POWer:SPAN?

Description Sets the span value of the sweep range for the power sweep for channel 1 (:SOUR1) to channel 4 (:SOUR4).

Parameters

	<numeric>
Description	Span value
Range	Varies depending on the power range.
Preset value	5
Unit	dBm
Resolution	0.05

If the specified parameter is out of the allowable setup range, the minimum value (if the lower limit of the range is not reached) or the maximum value (if the upper limit of the range is exceeded) is set.

Query response {numeric}<newline><^END>

Example of use

```
10  OUTPUT 717;":SOUR1:POW:SPAN 10"
20  OUTPUT 717;":SOUR1:POW:SPAN?"
30  ENTER 717;A
```

Related commands :SENS{1-4}:SWE:TYPE on page 426
 :SOUR{1-4}:POW:ATT on page 430
 :SOUR{1-4}:POW:CENT on page 431

Equivalent key **[Span]**

:SOUR{1-4}:POW:STAR

Syntax :SOURce{[1]|2|3|4}:POWer:STARt <numeric>
:SOURce{[1]|2|3|4}:POWer:STARt?

Description Sets the start value of the sweep range for the power sweep for channel 1 (:SOUR1) to channel 4 (:SOUR4).

Parameters

	<numeric>
Description	Start value
Range	Varies depending on the power range.
Preset value	-5
Unit	dBm
Resolution	0.05

If the specified parameter is out of the allowable setup range, the minimum value (if the lower limit of the range is not reached) or the maximum value (if the upper limit of the range is exceeded) is set.

Query response {numeric}<newline><^END>

Example of use
10 OUTPUT 717;":SOUR1:POW:STAR -10"
20 OUTPUT 717;":SOUR1:POW:STAR?"
30 ENTER 717;A

Related commands :SENS{1-4}:SWE:TYPE on page 426
:SOUR{1-4}:POW:ATT on page 430
:SOUR{1-4}:POW:STOP on page 438

Equivalent key **[Start]**

:SOUR{1-4}:POW:STOP

Syntax :SOURce{[1]|2|3|4}:POWer:STOP <numeric>
 :SOURce{[1]|2|3|4}:POWer:STOP?

Description Sets the stop value of the sweep range for the power sweep for channel 1 (:SOUR1) to channel 4 (:SOUR4).

Parameters

	<numeric>
Description	Stop value
Range	Varies depending on the power range.
Preset value	0
Unit	dBm
Resolution	0.05

If the specified parameter is out of the allowable setup range, the minimum value (if the lower limit of the range is not reached) or the maximum value (if the upper limit of the range is exceeded) is set.

Query response {numeric}<newline><^END>

Example of use
 10 OUTPUT 717;":SOUR1:POW:STOP 10"
 20 OUTPUT 717;":SOUR1:POW:STOP?"
 30 ENTER 717;A

Related commands :SENS{1-4}:SWE:TYPE on page 426
 :SOUR{1-4}:POW:ATT on page 430
 :SOUR{1-4}:POW:STAR on page 437

Equivalent key **[Stop]**

:STAT:OPER?

Syntax	:STATus:OPERation[:EVENT]?
Description	Reads out the value of the Operation Status Event Register. (Query only)
Query response	{numeric}<newline><^END>
Example of use	10 OUTPUT 717;":STAT:OPER?" 20 ENTER 717;A
Related commands	*CLS on page 194
Equivalent key	No equivalent key is available on the front panel.

:STAT:OPER:COND?

Syntax	:STATus:OPERation:CONDition?
Description	Reads out the value of the Operation Status Condition Register. (Query only)
Query response	{numeric}<newline><^END>
Example of use	10 OUTPUT 717;":STAT:OPER:COND?" 20 ENTER 717;A
Related commands	:STAT:OPER:NTR on page 441 :STAT:OPER:PTR on page 442
Equivalent key	No equivalent key is available on the front panel.

:STAT:OPER:ENAB

Syntax :STATus:OPERation:ENABLE <numeric>
 :STATus:OPERation:ENABLE?

Description Sets the value of the Operation Status Enable Register.

Parameters

	<numeric>
Description	Value of the enable register
Range	0 to 65535
Preset value	0
Resolution	1

Note that bit 0 to bit 3, bit 6 to bit 13 and bit 15 cannot be set to 1.

Query response {numeric}<newline><^END>

Example of use 10 OUTPUT 717; ":STAT:OPER:ENAB 16"
 20 OUTPUT 717; ":STAT:OPER:ENAB?"
 30 ENTER 717;A

Related commands *SRE on page 198

Equivalent key No equivalent key is available on the front panel.

:STAT:OPER:NTR

Syntax :STATus:OPERation:NTRansition <numeric>
:STATus:OPERation:NTRansition?

Description Sets the value of negative transition filter of the Operation Status Register.

Parameters

	<numeric>
Description	Value of the negative transition filter
Range	0 to 65535
Preset value	0
Resolution	1

Note that bit 0 to bit 3, bit 6 to bit 13 and bit 15 cannot be set to 1.

Query response {numeric}<newline><^END>

Example of use
10 OUTPUT 717;":STAT:OPER:NTR 16"
20 OUTPUT 717;":STAT:OPER:NTR?"
30 ENTER 717;A

Related commands :STAT:OPER? on page 439
:STAT:OPER:PTR on page 442

Equivalent key No equivalent key is available on the front panel.

:STAT:OPER:PTR

Syntax :STATus:OPERation:PTRansition <numeric>
:STATus:OPERation:PTRansition?

Description Sets the value of positive transition filter of the Operation Status Register.

Parameters

	<numeric>
Description	Value of the positive transition filter
Range	0 to 65535
Preset value	16432
Resolution	1

Note that bit 0 to bit 3, bit 6 to bit 13 and bit 15 cannot be set to 1.

Query response {numeric}<newline><^END>

Example of use
10 OUTPUT 717; ":STAT:OPER:PTR 16"
20 OUTPUT 717; ":STAT:OPER:PTR?"
30 ENTER 717;A

Related commands :STAT:OPER? on page 439
:STAT:OPER:NTR on page 441

Equivalent key No equivalent key is available on the front panel.

:STAT:PRES

Syntax	:STATus:PRESet
Description	Initialize the Operation Status Register, Questionable Status Register, Questionable Limit Status Register, Questionable Limit Extra Status Register, Questionable Limit Channel Status Register, and Questionable Limit Channel Extra Status Register. (No query)
Equivalent key	No equivalent key is available on the front panel.

:STAT:QUES?

Syntax	:STATus:QUEStionable[:EVENT]?
Description	Reads out the value of the Questionable Status Event Register. (Query only)
Query response	{numeric}<newline><^END>
Example of use	10 OUTPUT 717;":STAT:QUES?" 20 ENTER 717;A
Related commands	*CLS on page 194
Equivalent key	No equivalent key is available on the front panel.

:STAT:QUES:BLIM?

Syntax	:STATus:QUEStionable:BLIMit[:EVENT]?
Description	Reads out the value of the Questionable Bandwidth Limit Status Event Register. (Query only)
Query response	{numeric}<newline><^END>
Example of use	10 OUTPUT 717;":STAT:QUES:BLIM?" 20 ENTER 717;A
Related commands	*CLS on page 194
Equivalent key	No equivalent key is available on the front panel.

:STAT:QUES:BLIM:CHAN{1-4}?

Syntax	:STATus:QUEStionable:BLIMit:CHANnel{[1] 2 3 4}[:EVENT]?
Description	Reads out the value of the Questionable Bandwidth Limit Channel Status Event Register of channel 1 (:CHAN1) to channel 4 (:CHAN4). (Query only)
Query response	{numeric}<newline><^END>
Example of use	10 OUTPUT 717;":STAT:QUES:BLIM:CHAN1?" 20 ENTER 717;A
Related commands	*CLS on page 194
Equivalent key	No equivalent key is available on the front panel.

:STAT:QUES:BLIM:CHAN{1-4}:COND?

Syntax	:STATus:QUEStionable:BLIMit:CHANnel{[1] 2 3 4}:CONDition?
Description	Reads out the value of the Questionable Bandwidth Limit Channel Status Condition Register of channel 1 (:CHAN1) to channel 4 (:CHAN4). (Query only)
Query response	{numeric}<newline><^END>
Example of use	10 OUTPUT 717;":STAT:QUES:BLIM:CHAN1:COND?" 20 ENTER 717;A
Related commands	:STAT:QUES:BLIM:CHAN{1-4}:NTR on page 446 :STAT:QUES:BLIM:CHAN{1-4}:PTR on page 447
Equivalent key	No equivalent key is available on the front panel.

:STAT:QUES:BLIM:CHAN{1-4}:ENAB

Syntax :STATus:QUEStionable:BLIMit:CHANnel{[1]2|3|4}:ENABle <numeric>
:STATus:QUEStionable:BLIMit:CHANnel{[1]2|3|4}:ENABle?

Description Sets the value of the Questionable Bandwidth Limit Channel Status Enable Register of channel 1 (:CHAN1) to channel 4 (:CHAN4).

Parameters

	<numeric>
Description	Value of the enable register
Range	0 to 65535
Preset value	Varies depending on the upper limit setting for channel/trace number.
Resolution	1

Note that bit 5 to 15 cannot be set to 1.

Query response {numeric}<newline><^END>

Example of use
10 OUTPUT 717;" :STAT:QUES:BLIM:CHAN1:ENAB 16"
20 OUTPUT 717;" :STAT:QUES:BLIM:CHAN1:ENAB?"
30 ENTER 717;A

Related commands :STAT:QUES:BLIM:ENAB on page 448

Equivalent key No equivalent key is available on the front panel.

:STAT:QUES:BLIM:CHAN{1-4}:NTR

Syntax :STATus:QUEStionable:BLIMit:CHANnel{[1]|2|3|4}:NTRansition <numeric>
:STATus:QUEStionable:BLIMit:CHANnel{[1]|2|3|4}:NTRansition?

Description Sets the value of the negative transition filter of the Questionable Bandwidth Limit Channel Status Register of channel 1 (:CHAN1) to channel 4 (:CHAN4).

Parameters

	<numeric>
Description	Value of the negative transition filter
Range	0 to 65535
Preset value	0
Resolution	1

Note that bit 5 to 15 cannot be set to 1.

Query response {numeric}<newline><^END>

Example of use
10 OUTPUT 717;":STAT:QUES:BLIM:CHAN1:NTR 16"
20 OUTPUT 717;":STAT:QUES:BLIM:CHAN1:NTR?"
30 ENTER 717;A

Related commands :STAT:QUES:BLIM:CHAN{1-4}? on page 444
:STAT:QUES:BLIM:CHAN{1-4}:PTR on page 447

Equivalent key No equivalent key is available on the front panel.

:STAT:QUES:BLIM:CHAN{1-4}:PTR

- Syntax** :STATus:QUEStionable:BLIMit:CHANnel{[1]|2|3|4}:PTRansition <numeric>
:STATus:QUEStionable:BLIMit:CHANnel{[1]|2|3|4}:PTRansition?
- Description** Sets the value of the positive transition filter of the Questionable Bandwidth Limit Channel Status Register of channel 1 (:CHAN1) to channel 4 (:CHAN4).
- Parameters**

	<numeric>
Description	Value of the positive transition filter
Range	0 to 65535
Preset value	Varies depending on the upper limit setting for channel/trace number.
Resolution	1

Note that bit 5 to 15 cannot be set to 1.

- Query response** {numeric}<newline><^END>
- Example of use**
- ```
10 OUTPUT 717;":STAT:QUES:BLIM:CHAN1:PTR 16"
20 OUTPUT 717;":STAT:QUES:BLIM:CHAN1:PTR?"
30 ENTER 717;A
```
- Related commands** :STAT:QUES:BLIM:CHAN{1-4}? on page 444  
:STAT:QUES:BLIM:CHAN{1-4}:NTR on page 446

**Equivalent key** No equivalent key is available on the front panel.

## **:STAT:QUES:BLIM:COND?**

- Syntax** :STATus:QUEStionable:BLIMit:CONDition?
- Description** Reads out the value of the Questionable Bandwidth Limit Status Condition Register. (Query only)
- Query response** {numeric}<newline><^END>
- Example of use**
- ```
10 OUTPUT 717;":STAT:QUES:BLIM:COND?"
20 ENTER 717;A
```
- Related commands** :STAT:QUES:BLIM:NTR on page 449
:STAT:QUES:BLIM:PTR on page 450
- Equivalent key** No equivalent key is available on the front panel.

:STAT:QUES:BLIM:ENAB

Syntax :STATus:QUEStionable:BLIMit:ENABle <numeric>
 :STATus:QUEStionable:BLIMit:ENAB?

Description Sets the value of the Questionable Bandwidth Limit Status Enable Register.

Parameters

	<numeric>
Description	Value of the enable register
Range	0 to 65535
Preset value	Varies depending on the upper limit setting for channel/trace number.
Resolution	1

Note that bit 5 to 15 cannot be set to 1.

Query response {numeric}<newline><^END>

Example of use

```
10  OUTPUT 717; ":STAT:QUES:BLIM:ENAB 16"  
20  OUTPUT 717; ":STAT:QUES:BLIM:ENAB?"  
30  ENTER 717;A
```

Related commands :STAT:QUES:ENAB on page 452

Equivalent key No equivalent key is available on the front panel.

:STAT:QUES:BLIM:NTR

Syntax :STATus:QUEStionable:BLIMit:NTRansition <numeric>
:STATus:QUEStionable:BLIMit:NTRansition?

Description Sets the value of the negative transition filter of the Questionable Bandwidth Limit Status Register.

Parameters

	<numeric>
Description	Value of the negative transition filter
Range	0 to 65535
Preset value	0
Resolution	1

Note that bit 5 to 15 cannot be set to 1.

Query response {numeric}<newline><^END>

Example of use
10 OUTPUT 717;":STAT:QUES:BLIM:NTR 16"
20 OUTPUT 717;":STAT:QUES:BLIM:NTR?"
30 ENTER 717;A

Related commands :STAT:QUES:BLIM? on page 443
:STAT:QUES:BLIM:PTR on page 450

Equivalent key No equivalent key is available on the front panel.

:STAT:QUES:BLIM:PTR

Syntax :STATus:QUEStionable:BLIMit:PTRansition <numeric>
:STATus:QUEStionable:BLIMit:PTRansition?

Description Sets the value of the positive transition filter of the Questionable Bandwidth Limit Status Register.

Parameters

	<numeric>
Description	Value of the positive transition filter
Range	0 to 65535
Preset value	Varies depending on the upper limit setting for channel/trace number.
Resolution	1

Note that bit 5 to 15 cannot be set to 1.

Query response {numeric}<newline><^END>

Example of use
10 OUTPUT 717; ":STAT:QUES:BLIM:PTR 16"
20 OUTPUT 717; ":STAT:QUES:BLIM:PTR?"
30 ENTER 717;A

Related commands :STAT:QUES:BLIM? on page 443
:STAT:QUES:BLIM:NTR on page 449

Equivalent key No equivalent key is available on the front panel.

:STAT:QUES:COND?

Syntax	:STATus:QUEStionable:CONDition?
Description	Reads out the value of the Questionable Status Condition Register. (Query only)
Query response	{numeric}<newline><^END>
Example of use	10 OUTPUT 717;":STAT:QUES:COND?" 20 ENTER 717;A
Related commands	:STAT:QUES:NTR on page 461 :STAT:QUES:PTR on page 462
Equivalent key	No equivalent key is available on the front panel.

:STAT:QUES:ENAB

Syntax :STATus:QUEStionable:ENABle <numeric>
 :STATus:QUEStionable:ENAB?

Description Sets the value of the Questionable Status Enable Register.

Parameters

	<numeric>
Description	Value of the enable register
Range	0 to 65535
Preset value	0
Resolution	1

Note that bit 0 to bit 9 and bit 12 to bit 15 cannot be set to 1.

Query response {numeric}<newline><^END>

Example of use

```
10  OUTPUT 717; ":STAT:QUES:ENAB 16"  
20  OUTPUT 717; ":STAT:QUES:ENAB?"  
30  ENTER 717;A
```

Related commands *SRE on page 198

Equivalent key No equivalent key is available on the front panel.

:STAT:QUES:LIM?

Syntax	:STATus:QUEStionable:LIMit[:EVENT]?
Description	Reads out the value of the Questionable Limit Status Event Register. (Query only)
Query response	{numeric}<newline><^END>
Example of use	10 OUTPUT 717;":STAT:QUES:LIM?" 20 ENTER 717;A
Related commands	*CLS on page 194
Equivalent key	No equivalent key is available on the front panel.

:STAT:QUES:LIM:CHAN{1-4}?

Syntax	:STATus:QUEStionable:LIMit:CHANnel {[1] 2 3 4}[:EVENT]?
Description	Reads out the value of the Questionable Limit Channel Status Event Register of channel 1 (:CHAN1) to channel 4 (:CHAN4). (Query only)
Query response	{numeric}<newline><^END>
Example of use	10 OUTPUT 717;":STAT:QUES:LIM:CHAN1?" 20 ENTER 717;A
Related commands	*CLS on page 194
Equivalent key	No equivalent key is available on the front panel.

:STAT:QUES:LIM:CHAN{1-4}:COND?

Syntax	:STATus:QUEStionable:LIMit:CHANnel {[1] 2 3 4}:CONDition?
Description	Reads out the value of the Questionable Limit Channel Status Condition Register of channel 1 (:CHAN1) to channel 4 (:CHAN4). (Query only)
Query response	{numeric}<newline><^END>
Example of use	10 OUTPUT 717;":STAT:QUES:LIM:CHAN1:COND?" 20 ENTER 717;A
Related commands	:STAT:QUES:LIM:CHAN{1-4}:NTR on page 455 :STAT:QUES:LIM:CHAN{1-4}:PTR on page 456
Equivalent key	No equivalent key is available on the front panel.

:STAT:QUES:LIM:CHAN{1-4}:ENAB

Syntax :STATus:QUEStionable:LIMit:CHANnel{[1]2|3|4}:ENABle <numeric>
:STATus:QUEStionable:LIMit:CHANnel{[1]2|3|4}:ENABle?

Description Sets the value of the Questionable Limit Channel Status Enable Register of channel 1 (:CHAN1) to channel 4 (:CHAN4).

Parameters

	<numeric>
Description	Value of the enable register
Range	0 to 65535
Preset value	30
Resolution	1

Note that bit 5 to 15 cannot be set to 1.

Query response {numeric}<newline><^END>

Example of use
10 OUTPUT 717; ":STAT:QUES:LIM:CHAN1:ENAB 16"
20 OUTPUT 717; ":STAT:QUES:LIM:CHAN1:ENAB?"
30 ENTER 717;A

Related commands :STAT:QUES:LIM:ENAB on page 458

Equivalent key No equivalent key is available on the front panel.

:STAT:QUES:LIM:CHAN{1-4}:NTR

Syntax :STATus:QUEStionable:LIMit:CHANnel {[1]|2|3|4}:NTRansition <numeric>
:STATus:QUEStionable:LIMit:CHANnel {[1]|2|3|4}:NTRansition?

Description Sets the value of the negative transition filter of the Questionable Limit Channel Status Register of channel 1 (:CHAN1) to channel 4 (:CHAN4).

Parameters

	<numeric>
Description	Value of the negative transition filter
Range	0 to 65535
Preset value	0
Resolution	1

Note that bit 5 to 15 cannot be set to 1.

Query response {numeric}<newline><^END>

Example of use
10 OUTPUT 717;":STAT:QUES:LIM:CHAN1:NTR 16"
20 OUTPUT 717;":STAT:QUES:LIM:CHAN1:NTR?"
30 ENTER 717;A

Related commands :STAT:QUES:LIM:CHAN{1-4}? on page 453
:STAT:QUES:LIM:CHAN{1-4}:PTR on page 456

Equivalent key No equivalent key is available on the front panel.

:STAT:QUES:LIM:CHAN{1-4}:PTR

Syntax :STATus:QUEStionable:LIMit:CHANnel{[1]|2|3|4}:PTRansition <numeric>
:STATus:QUEStionable:LIMit:CHANnel{[1]|2|3|4}:PTRansition?

Description Sets the value of the positive transition filter of the Questionable Limit Channel Status Register of channel 1 (:CHAN1) to channel 4 (:CHAN4).

Parameters

	<numeric>
Description	Value of the positive transition filter
Range	0 to 65535
Preset value	30
Resolution	1

Note that bit 5 to 15 cannot be set to 1.

Query response {numeric}<newline><^END>

Example of use
10 OUTPUT 717; ":STAT:QUES:LIM:CHAN1:PTR 16"
20 OUTPUT 717; ":STAT:QUES:LIM:CHAN1:PTR?"
30 ENTER 717;A

Related commands :STAT:QUES:LIM:CHAN{1-4}? on page 453
:STAT:QUES:LIM:CHAN{1-4}:NTR on page 455

Equivalent key No equivalent key is available on the front panel.

:STAT:QUES:LIM:COND?

Syntax	:STATus:QUEStionable:LIMit:CONDition?
Description	Reads out the value of the Questionable Limit Status Condition Register. (Query only)
Query response	{numeric}<newline><^END>
Example of use	10 OUTPUT 717;":STAT:QUES:LIM:COND?" 20 ENTER 717;A
Related commands	:STAT:QUES:LIM:NTR on page 459 :STAT:QUES:LIM:PTR on page 460
Equivalent key	No equivalent key is available on the front panel.

:STAT:QUES:LIM:ENAB

Syntax :STATus:QUEStionable:LIMit:ENABle <numeric>
 :STATus:QUEStionable:LIMit:ENABle?

Description Sets the value of the Questionable Limit Status Enable Register.

Parameters

	<numeric>
Description	Value of the enable register
Range	0 to 65535
Preset value	30
Resolution	1

Note that bit 5 to 15 cannot be set to 1.

Query response {numeric}<newline><^END>

Example of use

```
10  OUTPUT 717; ":STAT:QUES:LIM:ENAB 16"  
20  OUTPUT 717; ":STAT:QUES:LIM:ENAB?"  
30  ENTER 717;A
```

Related commands :STAT:QUES:ENAB on page 452

Equivalent key No equivalent key is available on the front panel.

:STAT:QUES:LIM:NTR

Syntax :STATus:QUEStionable:LIMit:NTRansition <numeric>
:STATus:QUEStionable:LIMit:NTRansition?

Description Sets the value of the negative transition filter of the Questionable Limit Status Register.

Parameters

	<numeric>
Description	Value of the negative transition filter
Range	0 to 65535
Preset value	0
Resolution	1

Note that bit 5 to 15 cannot be set to 1.

Query response {numeric}<newline><^END>

Example of use
10 OUTPUT 717;" :STAT:QUES:LIM:CHAN1:NTR 16"
20 OUTPUT 717;" :STAT:QUES:LIM:CHAN1:NTR?"
30 ENTER 717;A

Related commands :STAT:QUES:LIM? on page 453
:STAT:QUES:LIM:PTR on page 460

Equivalent key No equivalent key is available on the front panel.

:STAT:QUES:LIM:PTR

Syntax :STATus:QUEStionable:LIMit:PTRansition <numeric>
:STATus:QUEStionable:LIMit:PTRansition?

Description Sets the value of the positive transition filter of the Questionable Limit Status Register.

Parameters

	<numeric>
Description	Value of the positive transition filter
Range	0 to 65535
Preset value	30
Resolution	1

Note that bit 5 to 15 cannot be set to 1.

Query response {numeric}<newline><^END>

Example of use
10 OUTPUT 717;":STAT:QUES:LIM:CHAN1:PTR 16"
20 OUTPUT 717;":STAT:QUES:LIM:CHAN1:PTR?"
30 ENTER 717;A

Related commands :STAT:QUES:LIM? on page 453
:STAT:QUES:LIM:NTR on page 459

Equivalent key No equivalent key is available on the front panel.

:STAT:QUES:NTR

Syntax :STATus:QUEStionable:NTRansition <numeric>
:STATus:QUEStionable:NTRansition?

Description Sets the value of negative transition filter of the Questionable Status Register.

Parameters

	<numeric>
Description	Value of the negative transition filter
Range	0 to 65535
Preset value	0
Resolution	1

Note that bit 0 to bit 9 and bit 12 to bit 15 cannot be set to 1.

Query response {numeric}<newline><^END>

Example of use
10 OUTPUT 717;":STAT:QUES:NTR 16"
20 OUTPUT 717;":STAT:QUES:NTR?"
30 ENTER 717;A

Related commands :STAT:QUES? on page 443
:STAT:QUES:PTR on page 462

Equivalent key No equivalent key is available on the front panel.

:STAT:QUES:PTR

Syntax :STATus:QUEStionable:PTRansition <numeric>
:STATus:QUEStionable:PTRansition?

Description Sets the value of positive transition filter of the Questionable Status Register.

Parameters

	<numeric>
Description	Value of the positive transition filter
Range	0 to 65535
Preset value	3072
Resolution	1

Note that bit 0 to bit 9 and bit 12 to bit 15 cannot be set to 1.

Query response {numeric}<newline><^END>

Example of use
10 OUTPUT 717; ":STAT:QUES:PTR 16"
20 OUTPUT 717; ":STAT:QUES:PTR?"
30 ENTER 717;A

Related commands :STAT:QUES? on page 443
:STAT:QUES:NTR on page 461

Equivalent key No equivalent key is available on the front panel.

:STAT:QUES:RLIM?

Syntax	:STATus:QUEStionable:RLIMit[:EVENT]?
Description	Reads out the value of the Questionable Ripple Limit Status Event Register. (Query only)
Query response	{numeric}<newline><^END>
Example of use	10 OUTPUT 717;":STAT:QUES:RLIM?" 20 ENTER 717;A
Related commands	*CLS on page 194
Equivalent key	No equivalent key is available on the front panel.

:STAT:QUES:RLIM:CHAN{1-4}?

Syntax	:STATus:QUEStionable:RLIMit:CHANnel{[1]2 3 4}[:EVENT]?
Description	Reads out the value of the Questionable Ripple Limit Channel Status Event Register of channel 1 (:CHAN1) to channel 4 (:CHAN4). (Query only)
Query response	{numeric}<newline><^END>
Example of use	10 OUTPUT 717;":STAT:QUES:RLIM:CHAN1?" 20 ENTER 717;A
Related commands	*CLS on page 194
Equivalent key	No equivalent key is available on the front panel.

:STAT:QUES:RLIM:CHAN{1-4}:COND?

Syntax	:STATus:QUEStionable:RLIMit:CHANnel{[1]2 3 4}:CONDition?
Description	Reads out the value of the Questionable Ripple Limit Channel Status Condition Register of channel 1 (:CHAN1) to channel 4 (:CHAN4). (Query only)
Query response	{numeric}<newline><^END>
Example of use	10 OUTPUT 717;":STAT:QUES:RLIM:CHAN1:COND?" 20 ENTER 717;A
Related commands	:STAT:QUES:RLIM:CHAN{1-4}:NTR on page 465 :STAT:QUES:RLIM:CHAN{1-4}:PTR on page 466
Equivalent key	No equivalent key is available on the front panel.

:STAT:QUES:RLIM:CHAN{1-4}:ENAB

Syntax :STATus:QUEStionable:RLIMit:CHANnel{[1]2|3|4}:ENABle <numeric>
:STATus:QUEStionable:RLIMit:CHANnel{[1]2|3|4}:ENABle?

Description Sets the value of the Questionable Ripple Limit Channel Status Enable Register of channel 1 (:CHAN1) to channel 4 (:CHAN4).

Parameters

	<numeric>
Description	Value of the enable register
Range	0 to 65535
Preset value	Varies depending on the upper limit setting for channel/trace number.
Resolution	1

Note that bit 5 to 15 cannot be set to 1.

Query response {numeric}<newline><^END>

Example of use
10 OUTPUT 717; ":STAT:QUES:RLIM:CHAN1:ENAB 16"
20 OUTPUT 717; ":STAT:QUES:RLIM:CHAN1:ENAB?"
30 ENTER 717;A

Related commands :STAT:QUES:RLIM:ENAB on page 467

Equivalent key No equivalent key is available on the front panel.

:STAT:QUES:RLIM:CHAN{1-4}:NTR

Syntax :STATus:QUEStionable:RLIMit:CHANnel{[1]|2|3|4}:NTRansition <numeric>
:STATus:QUEStionable:RLIMit:CHANnel{[1]|2|3|4}:NTRansition?

Description Sets the value of the negative transition filter of the Questionable Ripple Limit Channel Status Register of channel 1 (:CHAN1) to channel 4 (:CHAN4).

Parameters

	<numeric>
Description	Value of the negative transition filter
Range	0 to 65535
Preset value	0
Resolution	1

Note that bit 5 to 15 cannot be set to 1.

Query response {numeric}<newline><^END>

Example of use
10 OUTPUT 717;":STAT:QUES:RLIM:CHAN1:NTR 16"
20 OUTPUT 717;":STAT:QUES:RLIM:CHAN1:NTR?"
30 ENTER 717;A

Related commands :STAT:QUES:RLIM:CHAN{1-4}? on page 463
:STAT:QUES:RLIM:CHAN{1-4}:PTR on page 466

Equivalent key No equivalent key is available on the front panel.

:STAT:QUES:RLIM:CHAN{1-4}:PTR

Syntax	:STATus:QUEStionable:RLIMit:CHANnel{[1]2 3 4}:PTRansition <numeric> :STATus:QUEStionable:RLIMit:CHANnel{[1]2 3 4}:PTRansition?
Description	Sets the value of the positive transition filter of the Questionable Ripple Limit Channel Status Register of channel 1 (:CHAN1) to channel 4 (:CHAN4).
Parameters	

	<numeric>
Description	Value of the positive transition filter
Range	0 to 65535
Preset value	Varies depending on the upper limit setting for channel/trace number.
Resolution	1

Note that bit 5 to 15 cannot be set to 1.

Query response	{numeric}<newline><^END>
Example of use	10 OUTPUT 717;":STAT:QUES:RLIM:CHAN1:PTR 16" 20 OUTPUT 717;":STAT:QUES:RLIM:CHAN1:PTR?" 30 ENTER 717;A

Related commands	:STAT:QUES:RLIM:CHAN{1-4}? on page 463 :STAT:QUES:RLIM:CHAN{1-4}:NTR on page 465
------------------	---

Equivalent key No equivalent key is available on the front panel.

:STAT:QUES:RLIM:COND?

Syntax	:STATus:QUEStionable:RLIMit:CONDition?
Description	Reads out the value of the Questionable Ripple Limit Status Condition Register. (Query only)
Query response	{numeric}<newline><^END>
Example of use	10 OUTPUT 717;":STAT:QUES:RLIM:COND?" 20 ENTER 717;A
Related commands	:STAT:QUES:RLIM:NTR on page 468 :STAT:QUES:RLIM:PTR on page 469
Equivalent key	No equivalent key is available on the front panel.

:STAT:QUES:RLIM:ENAB

Syntax :STATus:QUEStionable:RLIMit:ENABle <numeric>
:STATus:QUEStionable:RLIMit:ENABle?

Description Sets the value of the Questionable Ripple Limit Status Enable Register.

Parameters

	<numeric>
Description	Value of the enable register
Range	0 to 65535
Preset value	Varies depending on the upper limit setting for channel/trace number.
Resolution	1

Note that bit 5 to 15 cannot be set to 1.

Query response {numeric}<newline><^END>

Example of use

```
10 OUTPUT 717;":STAT:QUES:RLIM:ENAB 16"
20 OUTPUT 717;":STAT:QUES:RLIM:ENAB?"
30 ENTER 717;A
```

Related commands :STAT:QUES:ENAB on page 452

Equivalent key No equivalent key is available on the front panel.

:STAT:QUES:RLIM:NTR

Syntax :STATus:QUEStionable:RLIMit:NTRansition <numeric>
:STATus:QUEStionable:RLIMit:NTRansition?

Description Sets the value of the negative transition filter of the Questionable Ripple Limit Status Register.

Parameters

	<numeric>
Description	Value of the negative transition filter
Range	0 to 65535
Preset value	0
Resolution	1

Note that bit 5 to 15 cannot be set to 1.

Query response {numeric}<newline><^END>

Example of use
10 OUTPUT 717; ":STAT:QUES:RLIM:NTR 16"
20 OUTPUT 717; ":STAT:QUES:RLIM:NTR?"
30 ENTER 717;A

Related commands :STAT:QUES:RLIM? on page 463
:STAT:QUES:RLIM:PTR on page 469

Equivalent key No equivalent key is available on the front panel.

:STAT:QUES:RLIM:PTR

Syntax :STATus:QUEStionable:RLIMit:PTRansition <numeric>
:STATus:QUEStionable:RLIMit:PTRansition?

Description Sets the value of the positive transition filter of the Questionable Ripple Limit Status Register.

Parameters

	<numeric>
Description	Value of the positive transition filter
Range	0 to 65535
Preset value	Varies depending on the upper limit setting for channel/trace number.
Resolution	1

Note that bit 5 to 15 cannot be set to 1.

Query response {numeric}<newline><^END>

Example of use
10 OUTPUT 717;":STAT:QUES:RLIM:PTR 16"
20 OUTPUT 717;":STAT:QUES:RLIM:PTR?"
30 ENTER 717;A

Related commands :STAT:QUES:RLIM? on page 463
:STAT:QUES:RLIM:NTR on page 468

Equivalent key No equivalent key is available on the front panel.

:SYST:BACK

Syntax :SYSTem:BACKlight {ON|OFF|1|0}
:SYSTem:BACKlight?

Description Turns ON/OFF the backlight of the LCD display.
When the backlight is OFF, you cannot read the information on the display.

Parameters

	Description
ON or 1 (preset value)	Turns ON the backlight.
OFF or 0	Turns OFF the backlight.

Query response {1|0}<newline><^END>

Example of use
10 OUTPUT 717; ":SYST:BACK OFF"
20 OUTPUT 717; ":SYST:BACK?"
30 ENTER 717;A

Equivalent key **[System] - Backlight**
To turn it ON, press any key on the front panel.

:SYST:BEEP:COMP:IMM

Syntax	:SYSTem:BEEPer:COMPLete:IMMEDIATE
Description	Generates a beep for the notification of the completion of the operation. (No query)
Example of use	10 OUTPUT 717;":SYST:BEEP:COMP:IMM"
Related commands	:SYST:BEEP:COMP:STAT on page 471 :SYST:BEEP:WARN:IMM on page 472
Equivalent key	[System] - Misc Setup - Beeper - Test Beep Complete

:SYST:BEEP:COMP:STAT

Syntax	:SYSTem:BEEPer:COMPLete:STATe {ON OFF 1 0} :SYSTem:BEEPer:COMPLete:STATe?
Description	Turns ON/OFF the beeper for the notification of the completion of the operation.
Parameters	

	Description
ON or 1 (preset value)	Turns ON the beeper.
OFF or 0	Turns OFF the beeper.

Query response	{1 0}<newline><^END>
Example of use	10 OUTPUT 717;":SYST:BEEP:COMP:STAT OFF" 20 OUTPUT 717;":SYST:BEEP:COMP:STAT?" 30 ENTER 717;A
Related commands	:SYST:BEEP:COMP:IMM on page 471 :SYST:BEEP:WARN:STAT on page 472
Equivalent key	[System] - Misc Setup - Beeper - Beep Complete

:SYST:BEEP:WARN:IMM

Syntax	:SYSTem:BEEPer:WARNing:IMMediate
Description	Generates a beep for the notification of warning/limit test result. (No query)
Example of use	10 OUTPUT 717; ":SYST:BEEP:WARN:IMM"
Related commands	:SYST:BEEP:WARN:STAT on page 472 :SYST:BEEP:COMP:IMM on page 471
Equivalent key	[System] - Misc Setup - Beeper - Test Beep Warning

:SYST:BEEP:WARN:STAT

Syntax	:SYSTem:BEEPer:WARNing:STATe {ON OFF 1 0} :SYSTem:BEEPer:WARNing:STATe?
Description	Turns ON/OFF the beeper for the notification of warning/limit test result.
Parameters	

	Description
ON or 1 (preset value)	Turns ON the beeper.
OFF or 0	Turns OFF the beeper.

Query response	{1 0}<newline><^END>
Example of use	10 OUTPUT 717; ":SYST:BEEP:WARN:STAT OFF" 20 OUTPUT 717; ":SYST:BEEP:WARN:STAT?" 30 ENTER 717;A
Related commands	:SYST:BEEP:WARN:IMM on page 472 :SYST:BEEP:COMP:STAT on page 471
Equivalent key	[System] - Misc Setup - Beeper - Beep Warning

:SYST:DATE

Syntax :SYSTem:DATE <numeric 1>,<numeric 2>,<numeric 3>
:SYSTem:DATE?

Description Sets the date of the clock built in the E5061A/E5062A.

Parameters

	<numeric 1>	<numeric 2>	<numeric 3>
Description	Year	Month	Day
Range	1980 to 2099	1 to 12	1 to 31
Resolution	1	1	1

If the specified parameter is out of the allowable setup range, the minimum value (if the lower limit of the range is not reached) or the maximum value (if the upper limit of the range is exceeded) is set.

Query response {numeric 1},{numeric 2},{numeric 3}<newline><^END>

Example of use
 10 OUTPUT 717;":SYST:DATE 2002,1,1"
 20 OUTPUT 717;":SYST:DATE?"
 30 ENTER 717;A,B,C

Related commands :SYST:TIME on page 480
:DISP:CLOC on page 303

Equivalent key **[System] - Misc Setup - Clock Setup - Set Date and Time**

:SYST:ERR?

Syntax	:SYSTem:ERRor?
Description	Reads out the oldest error of the errors stored in the error queue of the E5061A/E5062A. The read-out error is deleted from the error queue. The size of the error queue is 100. Executing the *CLS command clears the errors stored in the error queue. (Query only)
NOTE	This command can not return an error that occurs by the manual operation or the COM object used in controlling the E5061A/E5062A from the VBA Macro.
Query response	{numeric},{string}<newline><^END> {numeric}: Error number {string}: Error message (a character string with double quotation marks ("")) If no error is stored in the error queue, 0 and "No error" are read out as the error number and the error message.
Example of use	10 OUTPUT 717;":SYST:ERR?" 20 ENTER 717;A,B\$
Related commands	*CLS on page 194
Equivalent key	No equivalent key is available on the front panel.

:SYST:KLOC:KBD

Syntax :SYSTem:KLOCK:KBD {ON|OFF|1|0}
:SYSTem:KLOCK:KBD?

Description Sets whether to lock the operation of the front panel (key and rotary knob) and keyboard.

Parameters

	Description
ON or 1	Specifies lock.
OFF or 0 (preset value)	Specifies unlock.

Query response {1|0}<newline><^END>

Example of use
10 OUTPUT 717;":SYST:KLOC:KBD ON"
20 OUTPUT 717;":SYST:KLOC:KBD?"
30 ENTER 717;A

Related commands :SYST:KLOC:MOUS on page 476

Equivalent key **[System] - Misc Setup - Key Lock - Front Panel & Keyboard Lock**

:SYST:KLOC:MOUS

Syntax :SYSTem:KLOCK:MOUSe {ON|OFF|1|0}
:SYSTem:KLOCK:MOUSe?

Description Sets whether to lock the operation of the mouse and touch screen.

Parameters

	Description
ON or 1	Specifies lock.
OFF or 0 (preset value)	Specifies unlock.

Query response {1|0}<newline><^END>

Example of use
10 OUTPUT 717;":SYST:KLOC:MOUS ON"
20 OUTPUT 717;":SYST:KLOC:MOUS?"
30 ENTER 717;A

Related commands :SYST:KLOC:KBD on page 475

Equivalent key **[System] - Misc Setup - Key Lock - Mouse Lock**

:SYST:POFF

Syntax	:SYSTem:POFF
Description	Turns OFF the E5061A/E5062A. (No query)
Example of use	10 OUTPUT 717;":SYST:POFF"
Equivalent key	Standby switch

:SYST:PRES

Syntax	:SYSTem:PRESet
Description	Performs preset. There is the following difference from the setting state preset with the *RST command. (No query) <ul style="list-style-type: none">• The continuous initiation mode of channel 1 is set to ON.
Example of use	10 OUTPUT 717;":SYST:PRES"
Related commands	*RST on page 197 :SYST:UPR on page 481
Equivalent key	[Preset] - OK

:SYST:SEC:LEV

Syntax :SYSTem:SECurity[:LEVel] {NON|LOW|HIGH}
:SYSTem:SECurity[:LEVel]?

Description Sets/Reads the security level.

Parameters

	Description
NON (preset value)	Turns OFF the security level.
LOW	Turns ON and specifies LOW level to the security level.
HIGH	Turns ON and specifies HIGH level to the security level.

When the setting of security level is LOW, it is able to change to NON or HIGH. But when this setting is HIGH, it is not able to change NON or LOW.

The setting of security level can be turned NON by executing the preset or recalling when the setting of security level is HIGH.

Even if the setting of security level is ON, the command that reads out the frequency is not influenced.

Query response {NON|LOW|HIGH}<newline><^END>

Example of use
10 OUTPUT 717;":SYST:SEC LOW"
20 OUTPUT 717;":SYST:SEC?"
30 ENTER 717;A\$

Equivalent key **[System] - Service Menu - Security Level - None|Low|High**

:SYST:SERV?

Syntax :SYSTem:SERVice?

Description Reads out whether to be in the service mode. (Query only)

Query response {1|0}<newline><^END>

	Description
1	In the service mode.
0	Not in the service mode.

Example of use
10 OUTPUT 717;":SYST:SERV?"
30 ENTER 717;A

Equivalent key Displayed on the instrument status bar (at the bottom of the LCD display).

:SYST:TIME

Syntax :SYSTem:TIME <numeric 1>,<numeric 2>,<numeric 3>
 :SYSTem:TIME?

Description Sets the time of the clock built in the E5061A/E5062A.

Parameters

	<numeric 1>	<numeric 2>	<numeric 3>
Description	Hour (24-hour basis)	Minute	Second
Range	0 to 23	0 to 59	0 to 59
Resolution	1	1	1

If the specified parameter is out of the allowable setup range, the minimum value (if the lower limit of the range is not reached) or the maximum value (if the upper limit of the range is exceeded) is set.

Query response {numeric 1},{numeric 2},{numeric 3}<newline><^END>

Example of use

```
10 OUTPUT 717;":SYST:TIME 17,30,0"
20 OUTPUT 717;":SYST:TIME?"
30 ENTER 717;A,B,C
```

Related commands :SYST:DATE on page 473
 :DISP:CLOC on page 303

Equivalent key **[System] - Misc Setup - Clock Setup - Set Date and Time**

:SYST:UPR

Syntax	:SYSTem:UPReset
Description	Executes the user-specified preset. The command is executed regardless of the preset operation mode. (No query) If the user-specified preset file (D:\UserPreset.sta) does not exist, a warning message is displayed, and “:SYST:PRES” is executed.
Example of use	10 OUTPUT 717;":SYST:UPR"
Related commands	*RST on page 197 :SYST:PRES on page 477
Equivalent key	[Preset] - OK

:TRIG

Syntax	:TRIGger[:SEQuence][:IMMediate]
Description	<p>Regardless of the setting of the trigger mode, generates a trigger immediately and executes a measurement.</p> <p>There is the following difference from the trigger with the :TRIG:SING command.</p> <ul style="list-style-type: none">• The execution of the command finishes at the time of a trigger. <p>If you execute this command when the trigger system is not in the trigger wait state (trigger event detection state), an error occurs and the command is ignored.</p> <p>For details about the trigger system, refer to “Trigger system” on page 78. (No query)</p>
Example of use	<pre>10 OUTPUT 717; ":TRIG"</pre>
Related commands	:TRIG:SING on page 482
Equivalent key	No equivalent key is available on the front panel.

:TRIG:SING

Syntax	:TRIGger[:SEQuence]:SINGle
Description	<p>Regardless of the setting of the trigger mode, generates a trigger immediately and executes a measurement.</p> <p>There is the following difference from the trigger with the :TRIG command.</p> <ul style="list-style-type: none">• The execution of the command finishes when the measurement (all sweeps) initiated with this command finishes. In other words, you can wait for the end of the measurement using the *OPC? command. <p>If you execute this command when the trigger system is not in the trigger wait state (trigger event detection state), an error occurs and the command is ignored.</p> <p>For details about the trigger system, refer to “Trigger system” on page 78. (No query)</p>
Example of use	<pre>10 OUTPUT 717; ":TRIG:SING" 20 OUTPUT 717; "*OPC?" 30 ENTER 717;A</pre>
Related commands	:TRIG on page 482 *OPC? on page 196
Equivalent key	No equivalent key is available on the front panel.

:TRIG:SOUR

Syntax :TRIGger[:SEQuence]:SOURce {INTernal|EXTernal|MANual|BUS}
:TRIGger[:SEQuence]:SOURce?

Description Selects the trigger source from the following 4 types.

Internal	Uses the internal trigger to generate continuous triggers automatically.
External	Generates a trigger when the trigger signal is inputted externally via the Ext Trig connector or the handler interface.
Manual	Generates a trigger when the key operation of [Trigger] - Trigger is executed from the front panel.
Bus	Generates a trigger when the *TRG command is executed.

When you change the trigger source during sweep, the sweep is canceled.

Parameters

	Description
INTernal (preset value)	Specifies internal.
EXTernal	Specifies external.
MANual	Specifies manual.
BUS	Specifies bus.

Query response {BUS|EXT|INT|MAN}<newline><^END>

Example of use

```
10 OUTPUT 717;":TRIG:SOUR BUS"
20 OUTPUT 717;":TRIG:SOUR?"
30 ENTER 717;A$
```

Related commands *TRG on page 199

Equivalent key **[Trigger] - Trigger Source - Internal|External|Manual|Bus**

Command list

Command tree

Table 13-1 shows the SCPI command tree of the E5061A/E5062A.

Table 13-1 E5061A/E5062A SCPI command tree

Command	Parameters	Note
ABORt		[No query]
CALCulate{[1]2 3 4}		
:PARAmeter		
:COUNt	<numeric>	
:PARAmeter {[1]2 3 4}		
:DEFine	{S11 S21 S12 S22}	
:SElect		[No query]
[:SElected]		
:BLIMit		
:DB	<numeric>	
:DISPlay		
:MARKer	{ON OFF 1 0}	
:VALue	{ON OFF 1 0}	
:FAIL?		[Query only]
:MAXimum	<numeric>	
:MINimum	<numeric>	
:REPort		
[:DATA]?		[Query only]
[:STATe]	{ON OFF 1 0}	
:CONVersion		
:FUNction	{ZREFlection ZTRansmit YREFlection YTRansmit INVersion}	
[:STATe]	{ON OFF 1 0}	
:CORRection		
:EDELay		
:TIME	<numeric>	
:OFFSet		
:PHASe	<numeric>	
:DATA		
:FDATa	<numeric>,...,<numeric> (number of measurement points × 2 parameters)	
:FMEMory	<numeric>,...,<numeric> (number of measurement points × 2 parameters)	
:SDATa	<numeric>,...,<numeric> (number of measurement points × 2 parameters)	
:SMEMory	<numeric>,...,<numeric> (number of measurement points × 2 parameters)	
:FORMat	{MLOGarithmic PHASe GDElay SLINear SLOGarithmic SCOMplex SMITH SADMittance PLINear PLOGarithmic POLar MLINear SWR REAL IMAGinary UPHase PPHase}	

Table 13-1 E5061A/E5062A SCPI command tree

Command	Parameters	Note
CALCulate{[1] 2 3 4}		
[:SELeCted]		
:FUNcTion		
:DOMain		
:COUPle	{ON OFF 1 0}	
:STARt	<numeric>	
[:STATe]	{ON OFF 1 0}	
:STOP	<numeric>	
:EXECute		[No query]
:PEXCursion	<numeric>	
:POINts?		[Query only]
:PPOLarity	{POSitive NEGative BOTH}	
:TARGet	<numeric>	
:TTRansition	{POSitive NEGative BOTH}	
:TYPE	{PTPeak STDEV MEAN MAXimum MINimum PEAK APEak ATARget}	
:LIMit		
:DATA	<numeric>,...,<numeric> (1 + number of lines × 5 parameters)	
:DISPlay		
[:STATe]	{ON OFF 1 0}	
:CLIP	{ON OFF 1 0}	
:FAIL?		[Query only]
:OFFSet		
:AMPLitude	<numeric>	
:MARKer?		[Query only]
:STIMulus	<numeric>	
:REPort		
:ALL?		[Query only]
[:DATA]?		[Query only]
:POINts?		[Query only]
[:STATe]	{ON OFF 1 0}	
:MARKer		
:BWIDth		
[:STATe]	{ON OFF 1 0}	
:COUPle	{ON OFF 1 0}	
:DISCrete	{ON OFF 1 0}	
:FUNcTion		
:DOMain		
:COUPle	{ON OFF 1 0}	
:STARt	<numeric>	
[:STATe]	{ON OFF 1 0}	
:STOP	<numeric>	
:MULTi		
:PEXCursion	<numeric>	
:PPOLarity	{POSitive NEGative BOTH}	
:TARGet	<numeric>	
:TRACking	{ON OFF 1 0}	

Table 13-1 E5061A/E5062A SCPI command tree

Command	Parameters	Note
CALCulate{[1]2 3 4}		
[:SElected]		
:MARKer		
:FUNction		
:MULTi		
:TTRansition	{POSitive NEGative BOTH}	
:TYPE	{OFF PEAK TARGet}	
:MATH		
:FLATness		
:DATA?		[Query only]
[:STATE]	{ON OFF 1 0}	
:FStatistics		
:DATA?		[Query only]
[:STATE]	{ON OFF 1 0}	
:STSTistics		
:DATA?		[Query only]
[:STATE]	{ON OFF 1 0}	
:NOTCh		
[:STATE]	{ON OFF 1 0}	
:REFerence		
[:STATE]	{ON OFF 1 0}	
:MARKer{[1]2 3 4 5 6 7 8 9 10}		
:ACTivate		[No query]
:BWIDth		
:DATA?		[Query only]
:THReshold	<numeric>	
:FUNction		
:EXECute		[No query]
:PEXCursion	<numeric>	
:PPOLarity	{POSitive NEGative BOTH}	
:TARGet	<numeric>	
:TRACking	{ON OFF 1 0}	
:TTRansition	{POSitive NEGative BOTH}	
:TYPE	{MAXimum MINimum PEAK LPEak RPEak TARGet LTARget RTARget}	
:NOTCh		
:DATA?		[Query only]
:THReshold	<numeric>	
:SET	{STARt STOP CENTer RLEVel DELay}	[No query]
[:STATE]	{ON OFF 1 0}	
:X	<numeric>	
:Y?		[Query only]
:MATH		
:FUNction	{NORMal SUBTract DIVide ADD MULTIply}	
:MEMorize		[No query]

Table 13-1 E5061A/E5062A SCPI command tree

Command	Parameters	Note
CALCulate{[1] 2 3 4}		
[:SELEcted]		
:MStatistics		
:DATA?		[Query only]
[:STATe]	{ON OFF 1 0}	
:RLIMit		
:DATA	<numeric>,...,<numeric> (1 + number of lines × 4 parameters)	
:DISPlay		
:LINE	{ON OFF 1 0}	
:SELEct	<numeric>	
:VALue	{OFF ABSolute MARGin}	
:FAIL?		[Query only]
:REPort		
[:DATA]?		[Query only]
[:STATe]	{ON OFF 1 0}	
:SMOothing		
:APERture	<numeric>	
[:STATe]	{ON OFF 1 0}	
:TRANSform		
:TIME		
:CENTer	<numeric>	
:IMPulse		
:WIDTh	<numeric>	
:KBESsel	<numeric>	
:LPFRequency		[No query]
:SPAN	<numeric>	
:STARt	<numeric>	
:STATe	{ON OFF 1 0}	
:STEP		
:RTIME	<numeric>	
:STIMulus	{IMPulse STEP}	
:STOP	<numeric>	
[:TYPE]	{BPASs LPASs}	
CONTRol		
:HANDler		
:A		
[:DATA]	<numeric>	[No query]
:B		
[:DATA]	<numeric>	[No query]
:C		
[:DATA]	<numeric>	
:MODE	{INPut OUTPut}	
:D		
[:DATA]	<numeric>	
:MODE	{INPut OUTPut}	

Table 13-1 E5061A/E5062A SCPI command tree

Command	Parameters	Note
CONTrol		
:HANDler		
:E	[[:DATA]]	<numeric>
[:EXTension]		
:INDex		
:STATe		{ON OFF 1 0}
:RTRigger		
:STATe		{ON OFF 1 0}
:F		
[:DATA]		<numeric>
:OUTPut{[1] 2}		[No query]
[:DATA]		<numeric>
DISPlay		
:ANNotation		
:FREQuency		
[:STATe]		{ON OFF 1 0}
:CLOCK		{ON OFF 1 0}
:COLOr{[1] 2}		
:BACK		<numeric>,<numeric>,<numeric>
:GRATicule{[1] 2}		<numeric>,<numeric>,<numeric>
:LIMit{[1] 2}		<numeric>,<numeric>,<numeric>
:RESet		[No query]
:TRACe{[1] 2 3 4}		
:DATA		<numeric>,<numeric>,<numeric>
:MEMory		<numeric>,<numeric>,<numeric>
:ECHO		
:CLEar		[No query]
[:DATA]		<string>
[:DATA]		[No query]
:ENABle		{ON OFF 1 0}
:FSIGn		{ON OFF 1 0}
:IMAGe		{NORMal INVert}
:MAXimize		{ON OFF 1 0}
:SKEY		
[:STATe]		{ON OFF 1 0}
:SPLit		{D1 D12 D1_2 D112 D1_1_2 D123 D1_2_3 D12_33 D11_23 D13_23 D12_13 D1234 D1_2_3_4 D12_34}
:TABLe		
[:STATe]		{ON OFF 1 0}
:TYPE		{MARKer LIMit SEGment}
:UPDate		
[:IMMediate]		[No query]

Table 13-1 E5061A/E5062A SCPI command tree

Command	Parameters	Note
DISPlay		
:WINDow{[1]2 3 4}		
:ACTivate		[No query]
:ANNotation		
:MARKer		
:ALIGn	[[:STATe]	{ON OFF 1 0}
:SINGle	[[:STATe]	{ON OFF 1 0}
:LABel		{ON OFF 1 0}
:MAXimize		{ON OFF 1 0}
:SPLit		{D1 D12 D1_2 D112 D1_1_2 D123 D1_2_3 D12_33 D11_23 D13_23 D12_13 D1234 D1_2_3_4 D12_34}
:TITLe		
:DATA		<string>
[:STATe]		{ON OFF 1 0}
:TRACe{[1]2 3 4}		
:ANNotation		
:MARKer		
:POSition:X		<numeric>
:POSition:Y		<numeric>
:YAXis		
:MODE		{AUTO RELAtive}
:MEMory		
[:STATe]		{ON OFF 1 0}
:STATe		{ON OFF 1 0}
:Y		
[:SCALe]		
:AUTO		[No query]
:PDIVision		<numeric>
:RLEVel		<numeric>
:RPOSition		<numeric>
:TRACk		
:MODE		{OFF PEAK FREQuency}
:FREQuency		<numeric>
:X		
:SPACing		{LINear OBASe}
:Y		
[:SCALe]		
:DIVisions		<numeric>
FORMat		
:BORDER		{NORMal SWAPPed}
:DATA		{ASCii REAL REAL32}

Table 13-1 E5061A/E5062A SCPI command tree

Command	Parameters	Note
HCOpy		
:ABORt		[No query]
:IMAGe	{NORMal INVert}	
[:IMMediate]		[No query]
INITiate{[1] 2 3 4}		
:CONTinuous	{ON OFF 1 0}	
[:IMMediate]		[No query]
MMEMory		
:CATalog?	<string>	[Query only]
:COPY	<string>,<string>	[No query]
:DELeTe	<string>	[No query]
:LOAD		
:CHANnel		
:COEFFicient	{A B C D}	[No query]
[:STATe]	{A B C D}	[No query]
:LIMit	<string>	[No query]
:PROGram	<string>	[No query]
:SEGment	<string>	[No query]
[:STATe]	<string>	[No query]
:MDIRectory	<string>	[No query]
:STORe		
:CHANnel		
:CLEar		[No query]
:COEFFicient	{A B C D}	[No query]
[:STATe]	{A B C D}	[No query]
:FDATa	<string>	[No query]
:IMAGe	<string>	[No query]
:LIMit	<string>	[No query]
:PROGram	<string>	[No query]
:SALL	{ON OFF 1 0}	
:SEGment	<string>	[No query]
[:STATe]	<string>	[No query]
:STYPe	{STATe CSTate DSTate CDSTate}	
:TRANsfer	<string>,<block>	[No query]
OUTPut		
[:STATe]	{ON OFF 1 0}	
PROGram		
:CATalog?		[Query only]
[:SELeCted]		
:NAME	<string>	
:STATe	{STOP RUN}	

Table 13-1 E5061A/E5062A SCPI command tree

Command	Parameters	Note
SENSe		
:CORRection		
:COLLect		
:ECAL		
:PATH?		[Query only]
SENSe{[1] 2 3 4}		
:AVERage		
:CLEar		[No query]
:COUNt	<numeric>	
[:STATe]	{ON OFF 1 0}	
:BANDwidth		
[:RESolution]	<numeric>	
:BWIDth		
[:RESolution]	<numeric>	
:CORRection		
:CLEar		[No query]
:COEFFicient		
[:DATA]?	{ES ER ED EL ET EX}, <numeric>, <numeric>	[Query only]
:COLLect		
[:ACQuire]		
:ISOLation	<numeric>, <numeric>	
:LOAD	<numeric>	
:OPEN	<numeric>	
:SHORT	<numeric>	
:THRU	<numeric>, <numeric>	
:CKIT		
:LABel	<string>	
:ORDer		
:LOAD	<numeric>, <numeric>	
:OPEN	<numeric>, <numeric>	
:SHORT	<numeric>, <numeric>	
:THRU	<numeric>, <numeric>, <numeric>	
[:SElect]	<numeric>	
:STAN{[1] 2 3 4 5 6 7 8 9 10 11 12 13 14 15 16 17 18 19 20 21}		
:ARBitrary	<numeric>	
:C0	<numeric>	
:C1	<numeric>	
:C2	<numeric>	
:C3	<numeric>	
:DELay	<numeric>	
:L0	<numeric>	
:L1	<numeric>	
:L2	<numeric>	
:L3	<numeric>	
:LABel	<string>	

SCPI Command Reference
Command list

Table 13-1 E5061A/E5062A SCPI command tree

Command	Parameters	Note
SENSe{[1] 2 3 4}		
:CORRection		
:COLLect		
:CKIT		
:STAN{[1] 2 3 4 5 6 7 8 9 10 11 12 13 14 15 16 17 18 19 20 21}		
:LOSS	<numeric>	
:TYPE	{OPEN SHORT LOAD THRU ARBI NONE}	
:Z0	<numeric>	
:ECAL		
:ERESponse	<numeric>,<numeric>	[No query]
:ISOLation		
[:STATe]	{ON OFF 1 0}	
:SOLT1	<numeric>	
:SOLT2	<numeric>,<numeric>	
:THRU	<numeric>,<numeric>	
:METhod		
:ERESponse	<numeric>,<numeric>	
[:RESPOse]		
:OPEN	<numeric>	
:SHORT	<numeric>	
:THRU	<numeric>,<numeric>	
:SOLT1	<numeric>	
:SOLT2	<numeric>,<numeric>	
:TYPE?		[Query only]
:SAVE		[No query]
:EXTension		
:PORT{[1] 2}		
[:TIME]	<numeric>	
[:STATe]	{ON OFF 1 0}	
:PROPerTy	{ON OFF 1 0}	
:RVELOCITY		
:COAX	<numeric>	
:STATe	{ON OFF 1 0}	
:TYPE{[1] 2 3 4}?		[Query only]
:FREQuency		
:CENTer	<numeric>	
:[CW FIXed]	<numeric>	
:DATA?		[Query only]
:SPAN	<numeric>	
:STARt	<numeric>	
:STOP	<numeric>	
:ROSCillator		
:SOURce?		[Query only]

Table 13-1 E5061A/E5062A SCPI command tree

Command	Parameters	Note
SENSe{[1]2 3 4}		
:SEGMent		
:DATA	<numeric>,...,<numeric>	
:SWEep		
:POINts?		[Query only]
:TIME		
[:DATA]?		[Query only]
:SWEep		
:DELay	<numeric>	
:POINts	<numeric>	
:TIME		
:AUTO	{ON OFF 1 0}	
[:DATA]	<numeric>	
:TYPE	{LINear LOGarithmic SEGMent POWer}	
SERVice		
:CHANnel		
:ACTive?		[Query only]
:COUNT?		[Query only]
:TRACe		
:COUNT?		[Query only]
:CHANnel{[1]2 3 4}		
:TRACe		
:ACTive?		[Query only]
:PORT		
:COUNT?		[Query only]
SOURce{[1]2 3 4}		
:POWer		
:ATTenuation		
[:DATA]	<numeric>	
:CENTer	<numeric>	
[:LEVel]		
[:IMMediate]		
[:AMPLitude]	<numeric>	
:SLOPe		
[:DATA]	<numeric>	
:STATe	{ON OFF 1 0}	
:PORT		
:COUPle	{ON OFF 1 0}	
:PORT{[1]2}		
[:LEVel]		
[:IMMediate]		
[:AMPLitude]	<numeric>	
:SPAN	<numeric>	
:STARt	<numeric>	

Table 13-1 E5061A/E5062A SCPI command tree

Command	Parameters	Note
SOURce{[1]2[3]4}		
:POWer		
:STOP	<numeric>	
STATus		
:OPERation		
:CONDition?		[Query only]
:ENABle	<numeric>	
[:EVENT]?		[Query only]
:NTRansition	<numeric>	
:PTRansition	<numeric>	
:PRESet		[No query]
:QUEStionable		
:CONDition?		[Query only]
:ENABle	<numeric>	
[:EVENT]?		[Query only]
:LIMit		
:CHANnel{[1]2[3]4}		
:CONDition?		[Query only]
:ENABle	<numeric>	
[:EVENT]?		[Query only]
:NTRansition	<numeric>	
:PTRansition	<numeric>	
:CONDition?		[Query only]
:ENABle	<numeric>	
[:EVENT]?		[Query only]
:NTRansition	<numeric>	
:PTRansition	<numeric>	
STATus		
:QUEStionable		
:NTRansition	<numeric>	
:PTRansition	<numeric>	
SYSTem		
:BACKlight	{ON OFF 1 0}	
:BEEPer		
:COMPlete		
:IMMEDIATE		
:STATe	{ON OFF 1 0}	
:WARNIing		
:IMMEDIATE		
:STATe	{ON OFF 1 0}	
:DATE	<numeric>,<numeric>,<numeric>	
:ERRor?		[Query only]
:KLOCK		

Table 13-1 E5061A/E5062A SCPI command tree

Command	Parameters	Note
SYSTem		
:KLOCK		
:KBD	{ON OFF 1 0}	
:MOUSE	{ON OFF 1 0}	
:POFF		[No query]
:PRESet		[No query]
:SECurity		
[:LELe]	{NONE LOW HIGH}	
:SERvice?		[Query only]
:TIME	<numeric>,<numeric>,<numeric>	
:UPReset		[No query]
TRIGger		
[:SEQuence]		
[:IMMediate]		[No query]
:SINGle		[No query]
:SOURce	{INTernal EXTernal MANual BUS}	

A **Manual Changes**

This appendix contains the information required to adapt this manual to earlier versions or configurations of the Agilent E5061A/E5062A than that indicated by the current printing date of this manual. The information in this manual applies directly to the E5061A/E5062A model that has the serial number prefix listed on the title page of this manual.

Manual Changes

To adapt this manual to your Agilent E5061A/E5062A, refer to Table A-1 and Table A-2.

Table A-1 Manual Changes by Serial Number

Serial Prefix or Number	Make Manual Changes

Table A-2 Manual Changes by Firmware Version

Version	Make Manual Changes
A.02.00 or later	Change 1
A.02.10 or later	Change 2

Agilent Technologies uses a two-part, ten-character serial number that is stamped on the serial number plate (Figure A-1).

Execute the *IDN? command on page 196 to check the firmware version.

Figure A-1 Serial Number Plate (Example)

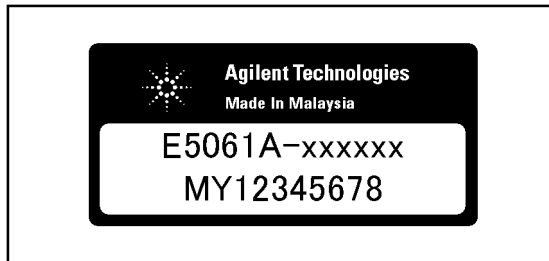

e5061auj2001

Change 2

The firmware revision A.02.00 or below does not support the following functions. Please disregard the descriptions of these functions in this manual.

- Offset limit line function
- Ripple test function
- Bandwidth test function

The firmware revision A.02.00 and below does not support the following SCPI commands. Please delete their descriptions in this manual.

- :CALC{1-4}:BLIM on page 201
- :CALC{1-4}:BLIM:DB on page 202
- :CALC{1-4}:BLIM:DISP:MARK on page 203
- :CALC{1-4}:BLIM:DISP:VAL on page 204
- :CALC{1-4}:BLIM:FAIL? on page 205
- :CALC{1-4}:BLIM:MAX on page 206
- :CALC{1-4}:BLIM:MIN on page 207
- :CALC{1-4}:BLIM:REP? on page 208
- :CALC{1-4}:LIM:OFFS:AMPL on page 236
- :CALC{1-4}:LIM:OFFS:MARK on page 237
- :CALC{1-4}:LIM:OFFS:STIM on page 238
- :CALC{1-4}:LIM:REP:ALL? on page 239
- :CALC{1-4}:RLIM on page 284
- :CALC{1-4}:RLIM:DATA on page 285
- :CALC{1-4}:RLIM:DISP:LINE on page 286
- :CALC{1-4}:RLIM:DISP:SEL on page 287
- :CALC{1-4}:RLIM:DISP:VAL on page 288
- :CALC{1-4}:RLIM:FAIL? on page 289
- :CALC{1-4}:RLIM:REP? on page 290
- :MMEM:LOAD:RLIM on page 348
- :MMEM:STOR:LIM on page 356
- :STAT:QUES:BLIM? on page 443
- :STAT:QUES:BLIM:CHAN{1-4}? on page 444
- :STAT:QUES:BLIM:CHAN{1-4}:COND? on page 444
- :STAT:QUES:BLIM:CHAN{1-4}:ENAB on page 445
- :STAT:QUES:BLIM:CHAN{1-4}:NTR on page 446
- :STAT:QUES:BLIM:CHAN{1-4}:PTR on page 447
- :STAT:QUES:BLIM:COND? on page 447

Manual Changes

Manual Changes

- :STAT:QUES:BLIM:ENAB on page 448
- :STAT:QUES:BLIM:NTR on page 449
- :STAT:QUES:BLIM:PTR on page 450
- :STAT:QUES:RLIM? on page 463
- :STAT:QUES:RLIM:CHAN{1-4}? on page 463
- :STAT:QUES:RLIM:CHAN{1-4}:COND? on page 463
- :STAT:QUES:RLIM:CHAN{1-4}:ENAB on page 464
- :STAT:QUES:RLIM:CHAN{1-4}:NTR on page 465
- :STAT:QUES:RLIM:CHAN{1-4}:PTR on page 466
- :STAT:QUES:RLIM:COND? on page 466
- :STAT:QUES:RLIM:ENAB on page 467
- :STAT:QUES:RLIM:NTR on page 468
- :STAT:QUES:RLIM:PTR on page 469

Change 1

The following functions are newly integrated into the firmware version A.02.00 onward. They are not supported by firmware version A.01.0x.

- User preset function.
- Notch search function
- Function to all the marker value are displayed.
- Function to change display position where marker value are displayed.
- Function to align the marker value.
- Display the overlap limit lines.
- Reference tracking function.
- Function to change display value where Y axis are displayed.
- Frequency information appearing as asterisks.
- User recovery function.*¹
- Remote control using HTTP.*¹

The firmware version A.01.0x does not support the following SCPI commands. Please delete their descriptions in this manual.

- :CALC{1-4}:LIM:DISP:CLIP on page 234
- :CALC{1-4}:MARK:NOTC on page 259
- :CALC{1-4}:MARK{1-10}:NOTC:DATA? on page 274

*1. This function is available when the volume label on the hard disk is AL200 or higher.

- :CALC{1-4}:MARK{1-10}:NOTC:THR on page 275
- :DISP:WIND{1-4}:ANN:MARK:ALIG on page 317
- :DISP:WIND{1-4}:ANN:MARK:SING on page 318
- :DISP:WIND{1-4}:TRAC{1-4}:ANN:MARK:POS:X on page 323
- :DISP:WIND{1-4}:TRAC{1-4}:ANN:MARK:POS:Y on page 324
- :DISP:WIND{1-4}:TRAC{1-4}:ANN:YAX:MODE on page 325
- :DISP:WIND{1-4}:TRAC{1-4}:Y:TRAC:FREQ on page 331
- :DISP:WIND{1-4}:TRAC{1-4}:Y:TRAC:MODE on page 332
- :SYST:SEC:LEV on page 478
- :SYST:UPR on page 481

Manual Changes
Manual Changes

B **Status Reporting System**

This appendix describes the status reporting system of the Agilent E5061A/E5062A.

General Status Register Model

The Agilent E5061A/E5062A has a status reporting system to report the condition of the instrument.

Figure B-1

General status register model

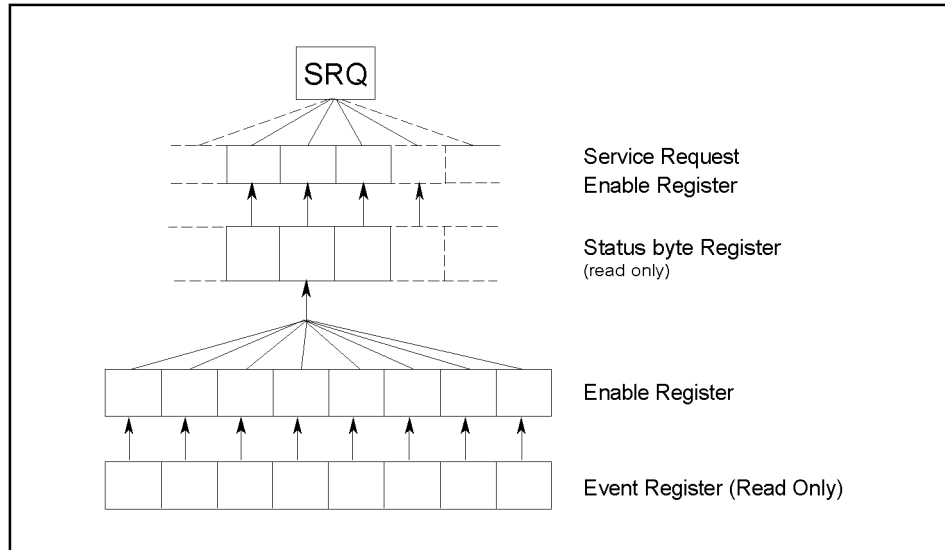

4294ape021

The status reporting system has a hierarchical structure as shown in Figure B-1. When the instrument satisfies a particular condition, the corresponding bit of the event register is set to 1. Therefore, you can check the instrument status by reading the event register.

When the event register bit is set to “1” and a corresponding enable register bit (a bit marked with an arrow in Figure B-1) is also “1,” the summary bit of the status byte register is set to “1.” You can read the status byte register by using the serial poll.

If the bit of the service request enable register is “1,” a service request (SRQ) is generated by the positive transition of the corresponding status byte register bit. By generating SRQ, you can notify the controller that the E5061A/E5062A is requesting service. In other words, interruption by SRQ can be programmed. For more information on using SRQ, see “Using the Status Register” on page 82 in Chapter 5, “Making a Measurement,” or “Using the status reporting system” on page 164 in Chapter 11, “Working with Automatic Test Systems.”

Event Register

Reflects the corresponding condition of the E5061A/E5062A (e.g., occurrence of an event) as a bit status. These bits continuously monitor changes in the E5061A/E5062A's state and change the bit status when the condition (e.g., change bit status to "1" if a specific event occurs) for each bit is met. You cannot change the bit status by issuing a SCPI command.

Enable Register

Setting the enable register allows you to specify event register bits that can set "1" to the summary bit of the status byte register when an event occurs. The register bits work as mask bits; setting "1" to an enable register will enable a corresponding bit in the event register.

For example, when you want to set "1" as the summary bit in the status byte register by a specific register condition, set the corresponding enable register to "1."

Status Byte Register

If the enabled event register is set to "1," a corresponding bit of the status byte register is also set to "1." This register also indicates the output queue and SRQ status.

The value of the status byte register can be read by using the ***STB?** command on page 199 command or serial poll (SPOLL statement in HTBasic) from the controller.

Reading the status byte register by using the ***STB?** command does not affect the contents of the status byte register. However, reading it with the SPOLL statement of HTBasic will clear the RQS bit in the status byte register.

Also, setting the service request enable register using the ***SRE** command on page 198 command can generate a service request synchronously with the status byte register.

Condition Register and Transition Filter

When the status register has a transition filter, there is a lower register called a condition register under the event register. The transition filter is between the event register and the condition register.

The transition filter enables you to select a positive and/or negative transition of the condition register bit in order to set a bit in the corresponding event register. For example, using the negative transition filter to set bit 3 to “1” causes bit 3 of the event register to be set to “1” when bit 3 of the condition register makes a negative transition, that is, changes from 1 to 0.

Figure B-2

Transition filter and condition register

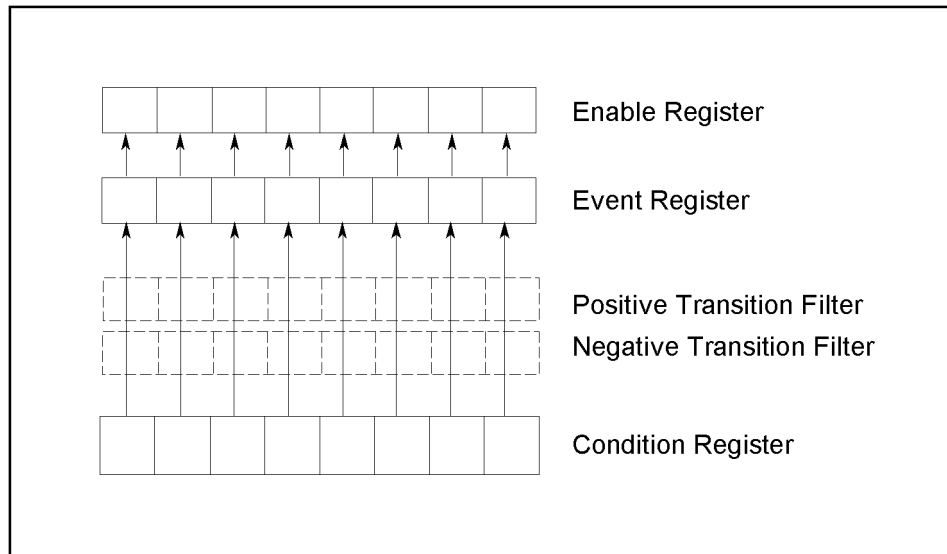

4294ape022

In the E5061A/E5062A, the following registers provide a condition register and transition filter:

- Operation status register
- Questionable status register
- Questionable limit status register
- Questionable limit extra status register
- Questionable limit channel {1-16} status register
- Questionable limit channel {1-16} extra status register

Status Register Structure

The status reporting system has a hierarchical structure as shown in Figure B-3 through Figure B-9. The status byte register is a summary of registers in the lower level. This section describes the E5061A/E5062A's status registers in each hierarchy. Each bit of the status register is described in Table B-1 through Table B-11.

Status Reporting System

Status Register Structure

Figure B-3 Status Register Structure (1 of 7)

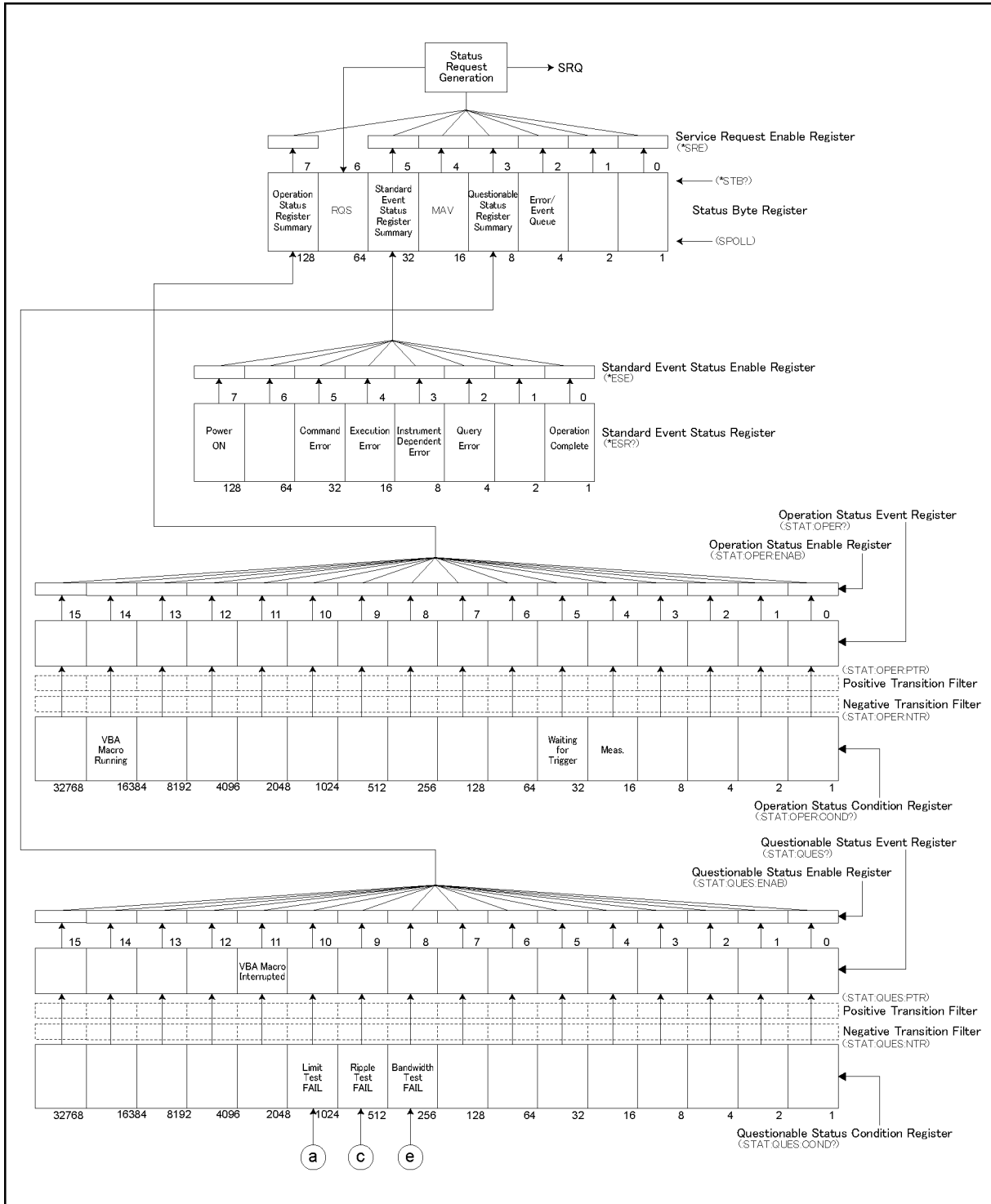

e5061ape3001

Figure B-4 Status Register Structure (2 of 7)

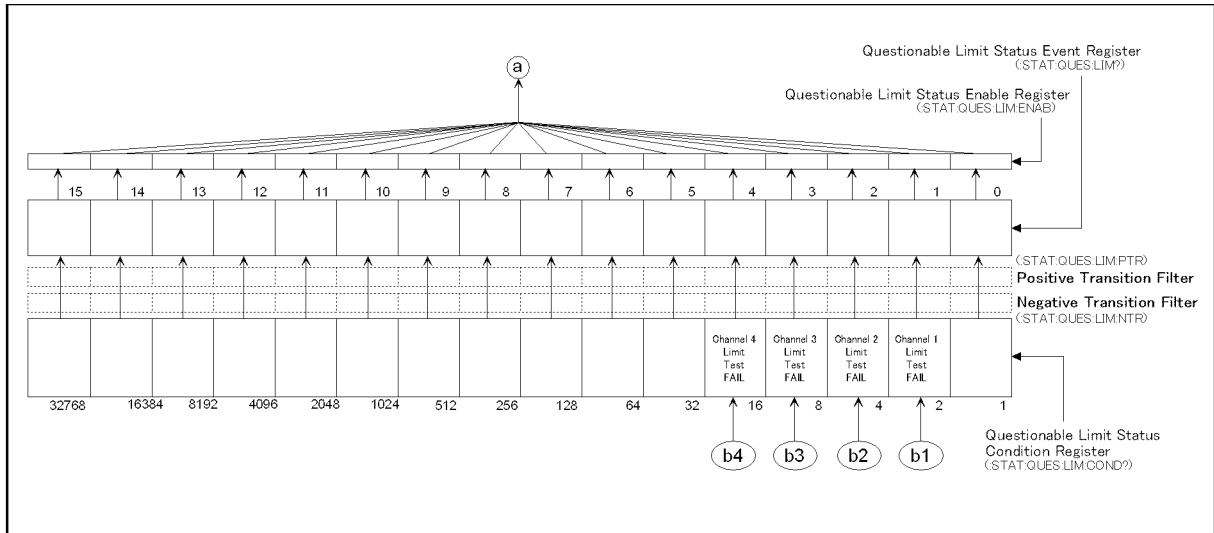

e5061ape0405

Figure B-5 Status Register Structure (3 of 7)

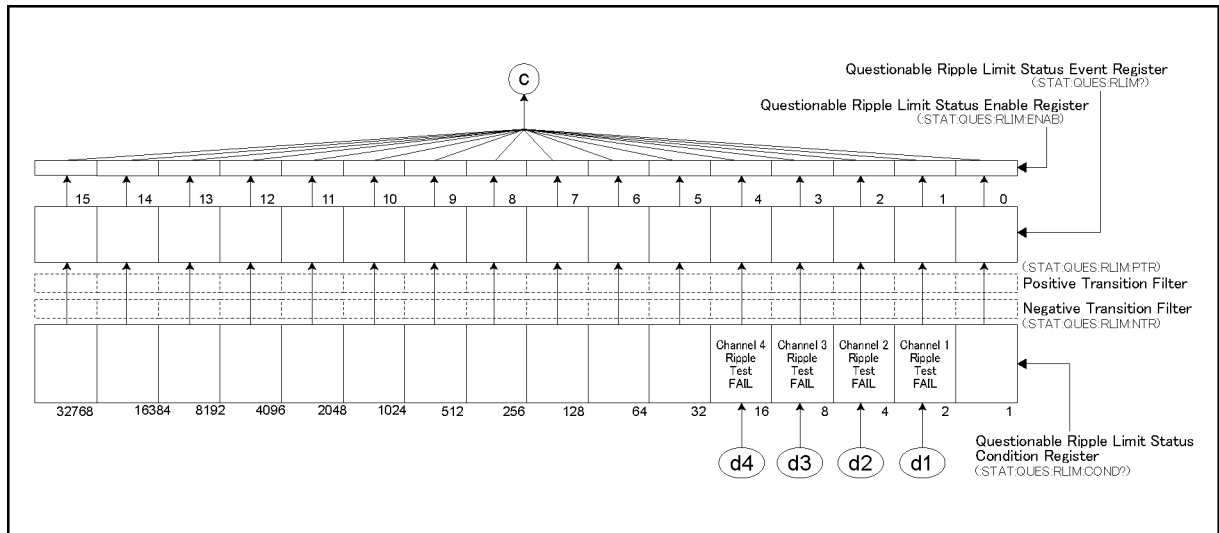

e5061ape3002

Status Reporting System
Status Register Structure

Figure B-6 Status Register Structure (4 of 7)

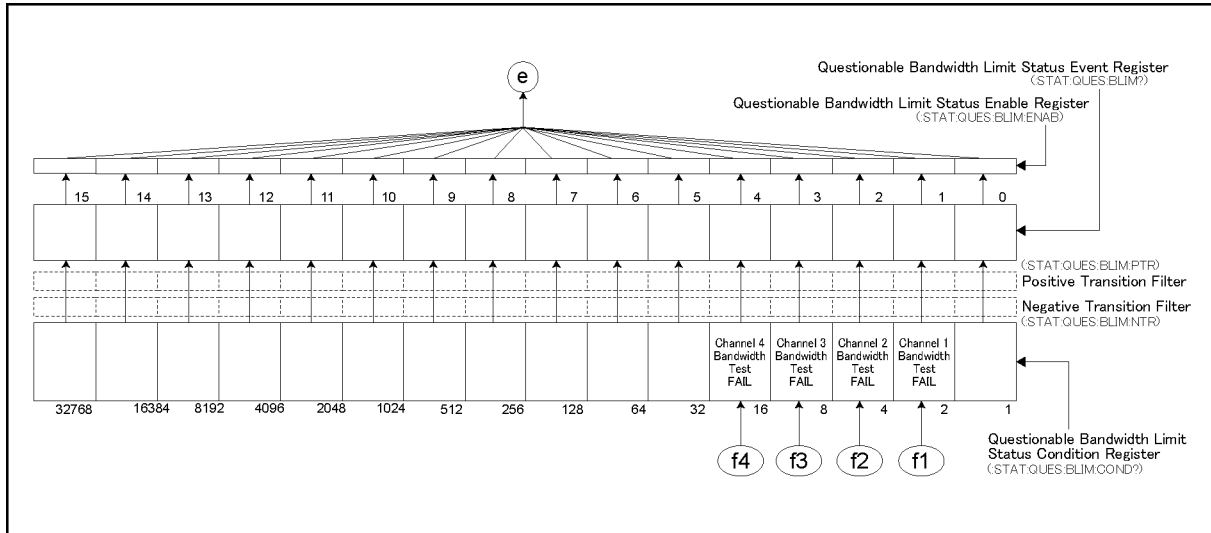

e5061ape3003

Figure B-7 Status Register Structure (5 of 7)

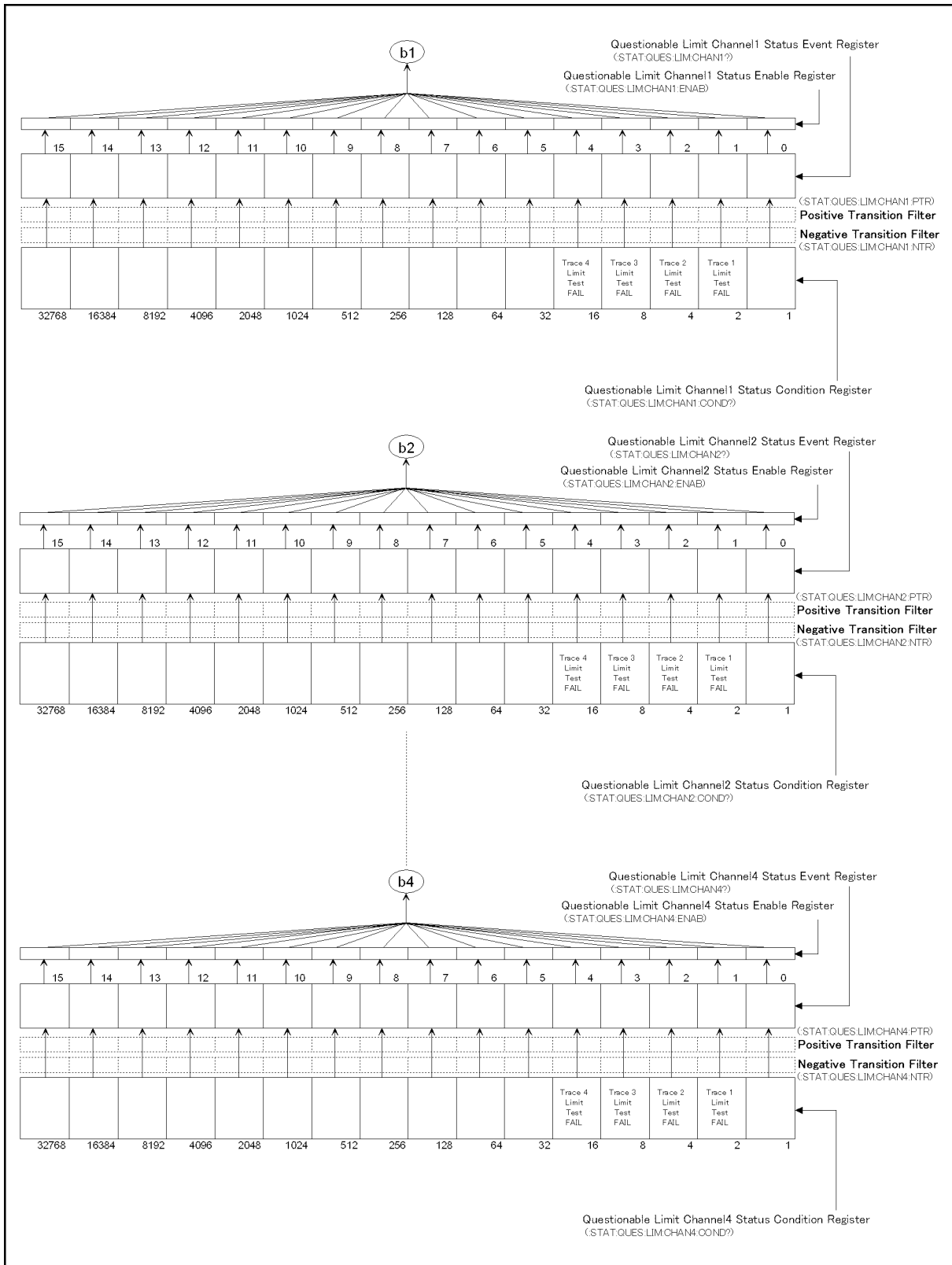

e5061ape0406

Status Reporting System
 Status Register Structure

Figure B-8 Status Register Structure (6 of 7)

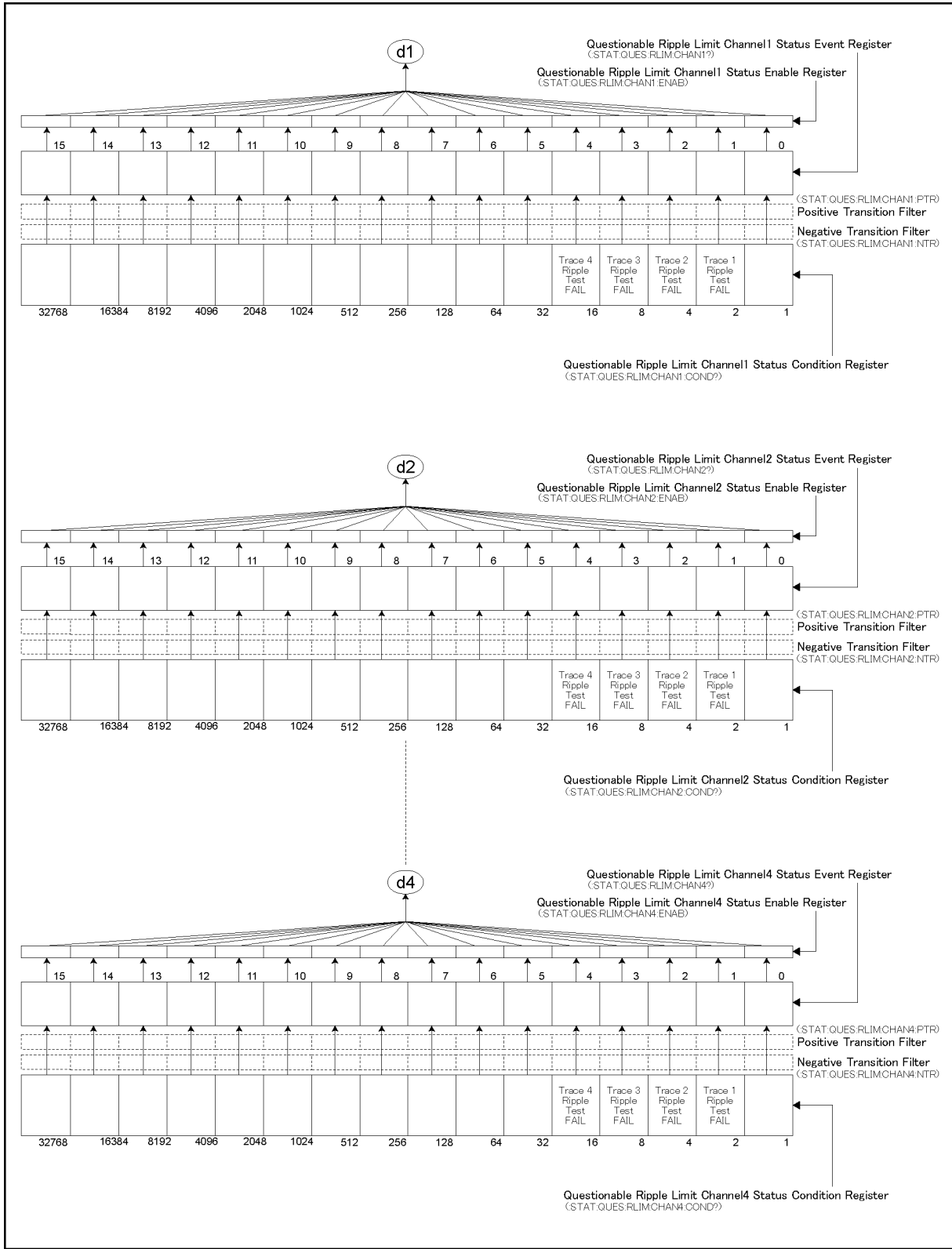

e5061ape3004

Figure B-9 Status Register Structure (7 of 7)

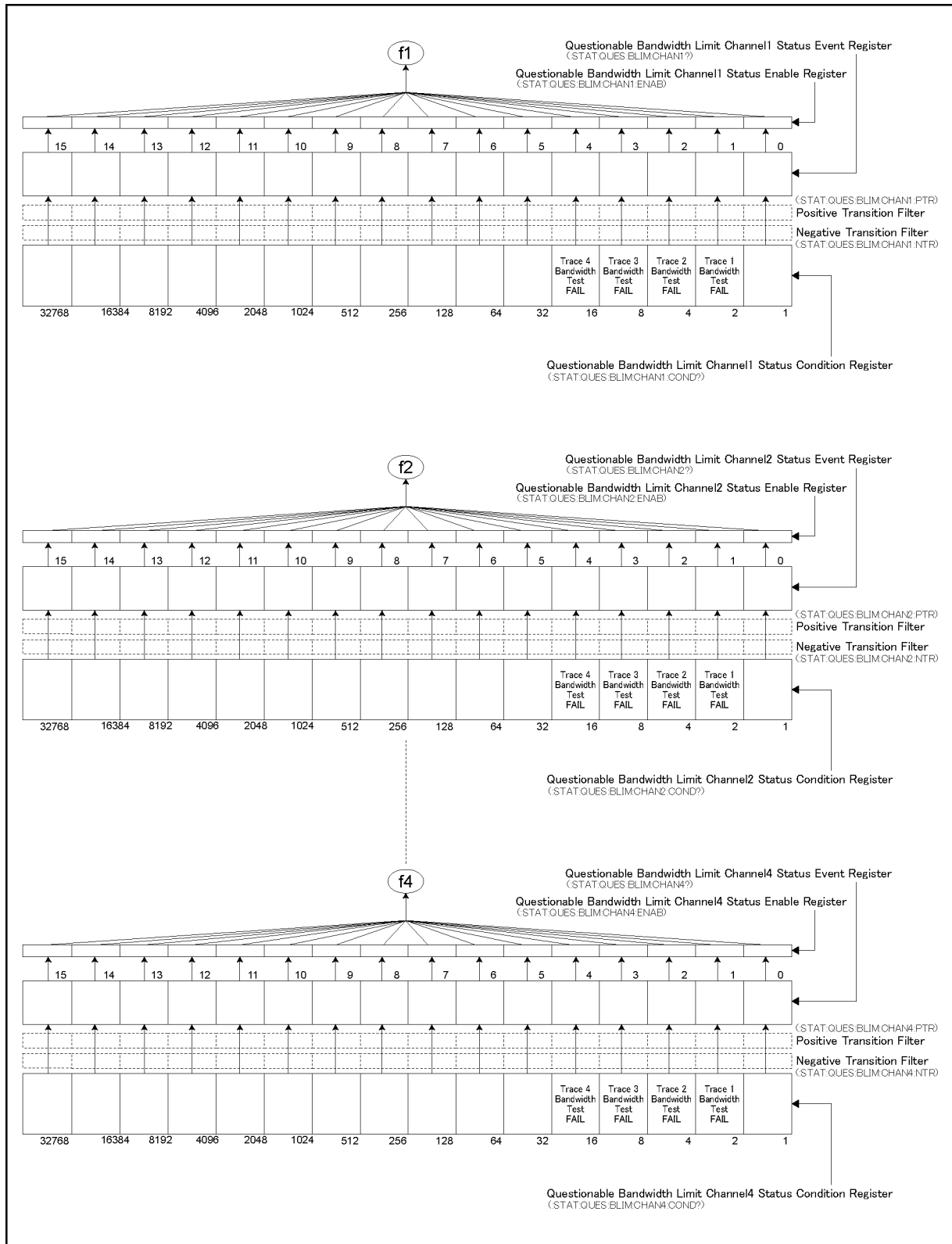

e5061ape3005

Table B-1

Status Bit Definitions of Status Byte Register

Bit Position	Name	Description
0, 1	Not used	Always 0
2	Error/Event Queue	Set to "1" if the error/event queue contains data; reset to "0" when all the data has been retrieved.
3	Questionable Status Register Summary	Set to "1" when one of the enabled bits in the status event status register is set to "1."
4	MAV (Message Available)	Set to "1" when the output queue contains data; reset to "0" when all the data has been retrieved.
5	Standard Event Status Register Summary	Set to "1" when one of the enabled bits in the status event status register is set to "1."
6	RQS	Set to "1" when any of the status byte register bits enabled by the service request enable register is set to "1"; reset to "0" when all the data has been retrieved through serial polling.
7	Operation Status Register Summary	Set to "1" when one of the enabled bits in the operational status register is set to "1."

Issuing the ***CLS** command will clear all bits from the status byte register.

Table B-2 Status Bit Definitions of Event Status Register (ESR)

Bit Position	Name	Description
0	Operation Complete	Set to "1" upon completion of all operations done by commands that precede the *OPC? command on page 196 command.
1	Not used	Always 0
2	Query Error	<ol style="list-style-type: none"> Set to "1" when the E5061A/E5062A receives a data output request but there is no data to output. Set to "1" when the data of the E5061A/E5062A's output queue has been cleared because of a new message received before the completion of data output.
3	Instrument Dependent Error	Set to "1" when an error has occurred and the error is not a command, query, or execution error.
4	Execution Error	<ol style="list-style-type: none"> Set to "1" when any parameter in an SCPI command exceeds its input range or is inconsistent with the E5061A/E5062A's capabilities. Set to "1" when an SCPI command cannot be properly executed due to some condition of the E5061A/E5062A.
5	Command Error	<ol style="list-style-type: none"> Set to "1" when an IEEE 488.2 syntax error occurs (a command sent to the E5061A/E5062A does not follow the IEEE 488.2 syntax). Possible violations include the command parameter violating the E5061A/E5062A listening formats or being unacceptable. Set to "1" when a semantic error occurs. Possible causes include a command containing misspellings being sent to the E5061A/E5062A or an IEEE 488.2 command not supported by the E5061A/E5062A being sent. Set to "1" when GET (Group Execution Trigger) is input while a program message is being received.
6	Not used	Always 0
7	Power ON	Set to "1" when the E5061A/E5062A is powered ON, or when the firmware is restarted.

Issuing the *CLS command will clear all bits from the standard event status register.

Table B-3

Status Bit Definitions of the Operation Status Condition Register

Bit Position	Name	Description
0 - 3	Not used	Always 0
4	Measurement	Set to “1” during measurement ^{*1} .
5	Waiting for Trigger	Set to “1” while the instrument is waiting for a trigger ^{*2} .
6 - 13	Not used	Always 0
14	VBA Macro Running	Set to “1” while a VBA macro is running.
15	Not used	Always 0

*1. This is the time from the beginning of the first sweep to the end of the last sweep when several sweeps are executed for one measurement.

*2. This is when the trigger system is in “Waiting for Trigger” state. For more information on the trigger system, refer to “Trigger system” on page 78.

Issuing the ***CLS** command will clear all bits from the operation status event register.

Table B-4

Status Bit Definitions of the Questionable Status Condition Register

Bit Position	Name	Description
0 - 7	Not used	Always 0
8	Bandwidth Test Fail (Questionable bandwidth limit status register summary)	Set to “1” while one of the enabled bits in the questionable bandwidth limit status event register is set to “1.”
9	Ripple Test Fail (Questionable ripple limit status register summary)	Set to “1” while one of the enabled bits in the questionable ripple limit status event register is set to “1.”
10	Limit Test Fail (Questionable limit status register summary)	Set to “1” while one of the enabled bits in the questionable limit status event register is set to “1.”
11 - 15	Not used	Always 0

Table B-5

Status Bit Definitions of the Questionable Status Event Register

Bit Position	Name	Description
0 - 7	Not used	Always 0
8	Bandwidth Test Fail (Questionable bandwidth limit status register summary)	Set to "1" when a transition of the condition register occurs if the transition filters are set as valid values.
9	Ripple Test Fail (Questionable ripple limit status register summary)	Set to "1" when a transition of the condition register occurs if the transition filters are set as valid values.
10	Limit Test Fail (Questionable limit status register summary)	Set to "1" when a transition of the condition register occurs if the transition filters are set as valid values.
11	VBA Macro Interrupted	Set to "1" when a VBA macro is interrupted by one of the following reasons.*1 <ul style="list-style-type: none"> • Occurrence of an execution error • Executing "End" statement in the VBA Macro • Executing :PROG:STAT STOP • Operating [Ctrl]+[Break] using the keyboard • Operating [Macro Break] or [Macro Setup] - Stop using the front panel
12 - 15	Not used	Always 0

*1. This setting is made after you click the **End** button in the dialog box displayed when the VBA macro is interrupted.

Issuing the ***CLS** command will clear all bits from the questionable status event register.

Table B-6

Status Bit Definitions of the Questionable Limit Status Condition Register

Bit Position	Name	Description
0	Not used	Always 0
1	Channel 1 Limit Test Fail (questionable limit channel 1 status register summary)	Set to "1" while one of the enabled bits in the questionable limit channel 1 status event register is set to "1."
2	Channel 2 Limit Test Fail (questionable limit channel 2 status register summary)	Set to "1" while one of the enabled bits in the questionable limit channel 2 status event register is set to "1."
3	Channel 3 Limit Test Fail (questionable limit channel 3 status register summary)	Set to "1" while one of the enabled bits in the questionable limit channel 3 status event register is set to "1."
4	Channel 4 Limit Test Fail (questionable limit channel 4 status register summary)	Set to "1" while one of the enabled bits in the questionable limit channel 4 status event register is set to "1."
5-15	Not used	Always 0

Issuing the ***CLS** command will clear all bits from the questionable bandwidth limit status event register.

Table B-7

Status Bit Definitions of the Questionable Limit Channel {1-4} Status Condition Register

Bit Position	Name	Description
0	Not used	Always 0
1	Trace 1 Limit Test Fail	Set to "0" when a measurement cycle begins; set to "1" when the measurement cycle finishes and returns "fail" as the limit test result for trace 1.
2	Trace 2 Limit Test Fail	Set to "0" when a measurement cycle begins; set to "1" when the measurement cycle finishes and returns "fail" as the limit test result for trace 2.
3	Trace 3 Limit Test Fail	Set to "0" when a measurement cycle begins; set to "1" when the measurement cycle finishes and returns "fail" as the limit test result for trace 3.
4	Trace 4 Limit Test Fail	Set to "0" when a measurement cycle begins; set to "1" when the measurement cycle finishes and returns "fail" as the limit test result for trace 4.
5-15	Not used	Always 0

Issuing the ***CLS** command will clear all the bits in the questionable limit channel {1-4} status event register.

Table B-8 **Status Bit Definitions of the Questionable Bandwidth Limit Status Condition Register**

Bit Position	Name	Description
0	Not used	Always 0
1	Channel 1 Bandwidth Test Fail (questionable bandwidth limit channel 1 status register summary)	Set to “1” while one of the enabled bits in the questionable bandwidth limit channel 1 status event register is set to “1.”
2	Channel 2 Bandwidth Test Fail (questionable bandwidth limit channel 2 status register summary)	Set to “1” while one of the enabled bits in the questionable bandwidth limit channel 2 status event register is set to “1.”
3	Channel 3 Bandwidth Test Fail (questionable bandwidth limit channel 3 status register summary)	Set to “1” while one of the enabled bits in the questionable bandwidth limit channel 3 status event register is set to “1.”
4	Channel 4 Bandwidth Test Fail (questionable bandwidth limit channel 4 status register summary)	Set to “1” while one of the enabled bits in the questionable bandwidth limit channel 4 status event register is set to “1.”
5-15	Not used	Always 0

Issuing the ***CLS** command will clear all bits from the questionable bandwidth limit status event register.

Table B-9 **Status Bit Definitions of the Questionable Bandwidth Limit Channel {1-4} Status Condition Register**

Bit Position	Name	Description
0	Not used	Always 0
1	Trace 1 Bandwidth Test Fail	Set to “0” when a measurement cycle begins; set to “1” when the measurement cycle finishes and returns “fail” as the bandwidth test result for trace 1.
2	Trace 2 Bandwidth Test Fail	Set to “0” when a measurement cycle begins; set to “1” when the measurement cycle finishes and returns “fail” as the bandwidth test result for trace 2.
3	Trace 3 Bandwidth Test Fail	Set to “0” when a measurement cycle begins; set to “1” when the measurement cycle finishes and returns “fail” as the bandwidth test result for trace 3.
4	Trace 4 Bandwidth Test Fail	Set to “0” when a measurement cycle begins; set to “1” when the measurement cycle finishes and returns “fail” as the bandwidth test result for trace 4.
5-15	Not used	Always 0

Issuing the ***CLS** command will clear all the bits in the questionable bandwidth limit channel {1-4} status event register.

Table B-10 **Status Bit Definitions of the Questionable Ripple Limit Status Condition Register**

Bit Position	Name	Description
0	Not used	Always 0
1	Channel 1 Ripple Test Fail (questionable ripple limit channel 1 status register summary)	Set to “1” while one of the enabled bits in the questionable ripple limit channel 1 status event register is set to “1.”
2	Channel 2 Ripple Test Fail (questionable ripple limit channel 2 status register summary)	Set to “1” while one of the enabled bits in the questionable ripple limit channel 2 status event register is set to “1.”
3	Channel 3 Ripple Test Fail (questionable ripple limit channel 3 status register summary)	Set to “1” while one of the enabled bits in the questionable ripple limit channel 3 status event register is set to “1.”
4	Channel 4 Ripple Test Fail (questionable ripple limit channel 4 status register summary)	Set to “1” while one of the enabled bits in the questionable ripple limit channel 4 status event register is set to “1.”
5-15	Not used	Always 0

Issuing the ***CLS** command will clear all bits from the questionable ripple limit status event register.

Table B-11 **Status Bit Definitions of the Questionable Ripple Limit Channel {1-4} Status Condition Register**

Bit Position	Name	Description
0	Not used	Always 0
1	Trace 1 Ripple Test Fail	Set to “0” when a measurement cycle begins; set to “1” when the measurement cycle finishes and returns “fail” as the ripple test result for trace 1.
2	Trace 2 Ripple Test Fail	Set to “0” when a measurement cycle begins; set to “1” when the measurement cycle finishes and returns “fail” as the ripple test result for trace 2.
3	Trace 3 Ripple Test Fail	Set to “0” when a measurement cycle begins; set to “1” when the measurement cycle finishes and returns “fail” as the ripple test result for trace 3.
4	Trace 4 Ripple Test Fail	Set to “0” when a measurement cycle begins; set to “1” when the measurement cycle finishes and returns “fail” as the ripple test result for trace 4.
5-15	Not used	Always 0

Issuing the ***CLS** command will clear all the bits in the questionable ripple limit channel {1-4} status event register.

Using the Status Reporting System

You can manage the status report system using the following commands in any combination:

- *CLS on page 194
- *SRE on page 198
- *STB? on page 199
- *ESE on page 195
- *ESR? on page 195
- :STAT:PRES on page 443
- :STAT:OPER:ENAB on page 440
- :STAT:OPER:COND? on page 439
- :STAT:OPER? on page 439
- :STAT:OPER:PTR on page 442
- :STAT:OPER:NTR on page 441
- :STAT:QUES:ENAB on page 452
- :STAT:QUES:COND? on page 451
- :STAT:QUES? on page 443
- :STAT:QUES:PTR on page 462
- :STAT:QUES:NTR on page 461
- :STAT:QUES:LIM:ENAB on page 458
- :STAT:QUES:LIM:COND? on page 457
- :STAT:QUES:LIM? on page 453
- :STAT:QUES:LIM:PTR on page 460
- :STAT:QUES:LIM:NTR on page 459
- :STAT:QUES:LIM:CHAN{1-4}:ENAB on page 454
- :STAT:QUES:LIM:CHAN{1-4}:COND? on page 453
- :STAT:QUES:LIM:CHAN{1-4}? on page 453
- :STAT:QUES:LIM:CHAN{1-4}:PTR on page 456
- :STAT:QUES:LIM:CHAN{1-4}:NTR on page 455
- :STAT:QUES:BLIM? on page 443
- :STAT:QUES:BLIM:CHAN{1-4}? on page 444
- :STAT:QUES:BLIM:CHAN{1-4}:COND? on page 444
- :STAT:QUES:BLIM:CHAN{1-4}:ENAB on page 445
- :STAT:QUES:BLIM:CHAN{1-4}:NTR on page 446
- :STAT:QUES:BLIM:CHAN{1-4}:PTR on page 447
- :STAT:QUES:BLIM:COND? on page 447
- :STAT:QUES:BLIM:ENAB on page 448
- :STAT:QUES:BLIM:NTR on page 449
- :STAT:QUES:BLIM:PTR on page 450
- :STAT:QUES:RLIM? on page 463
- :STAT:QUES:RLIM:CHAN{1-4}? on page 463
- :STAT:QUES:RLIM:CHAN{1-4}:COND? on page 463
- :STAT:QUES:RLIM:CHAN{1-4}:ENAB on page 464
- :STAT:QUES:RLIM:CHAN{1-4}:NTR on page 465
- :STAT:QUES:RLIM:CHAN{1-4}:PTR on page 466
- :STAT:QUES:RLIM:COND? on page 466
- :STAT:QUES:RLIM:ENAB on page 467
- :STAT:QUES:RLIM:NTR on page 468
- :STAT:QUES:RLIM:PTR on page 469

Status Reporting System

Using the Status Reporting System

For sample programs that demonstrate the use of the commands listed above, refer to “Using the Status Register” on page 82 in Chapter 5 or “Obtaining Test Results” on page 119 in Chapter 8.

C **Error Messages**

The Agilent E5061A/E5062A provides error messages to indicate its operating status. This appendix describes the error messages of the E5061A/E5062A in order of error number.

Error Messages

An error message is displayed against a red background in the instrument message/warning area in the lower left part of the screen. Pushing a front panel key or executing **:DISP:CCL** command clears the error message. Errors caused by the operation of a front panel key simply appear on the display. They are not stored in the error queue with some exceptions.

An error with a positive error number is one uniquely defined for this instrument. On the other hand, an error with a negative error number is basically one defined for common GPIB devices in IEEE488.2

A

20

Additional standard needed

The GPIB command that turns ON the calibration function has been sent before all of the data measurements needed to calculate the calibration factor have been completed. For instance, the “SENS:CORR:COLL:SAVE” command is sent to calculate calibration coefficients and turn on error correction for 1-Port Calibration when open and short calibration are completed but load calibration is not completed. Be sure to measure all necessary calibration data before sending commands. This error is not generated by front key operations.

77

Additional test set calibration needed

Multiport test set calibration needs to be completed. This error occurs when Slef Cal (SENS:CORR:MULT:SELF:ONCE) is performed without having test set calibration completed.

B

-168

Block data not allowed

An block-data element has been received at a position where this instrument does not accept one.

C

240

Calibration data lost

This error occurs when a file containing the system calibration data is not found or in a damaged state at time of the startup of this instrument, indicating a failure of this instrument. Contact an Agilent Technology sales office or the company from which you bought the instrument.

22

Calibration method not selected

This error occurs when the command for validating the calibration, SENS:CORR:COLL:SAVE, is executed before the command for selecting a calibration type, SENS:CORR:COLL:METH:xxxx, is executed. This error is not generated by front key operations.

-148

Character data not allowed

A character data element (not violating the standard) has been received at a position where

this instrument does not accept one. Double quotes (“”) are omitted where it is necessary to place a parameter in double quotes (“”), for example.

-100

Command error

A comprehensive syntax error has occurred showing that this instrument cannot detect a more detailed error. This code simply shows that a command error defined in 11.5.1.1.4, IEEE488.2 has occurred.

D

-222

Data out of range

A data element (not violating the standard) outside the range defined by this instrument has been received. This error occurs when an integer-based command for which the parameter can be rounded exceeds the range of -65536 to +65536 or when a real-number-based command for which the parameter can be rounded exceeds the range of -9.9e37 to +9.9e37, for example.

This error occurs also when a numeric value other than a specified one is entered into a command in which the “port number” and “CalKit number” are specified as parameters and hence the parameters are not rounded. Such commands are, for example, SENS:CORR:COLL:ACQ:OPEN, SENS:CORR:COLL:ECAL:SOLT1, SENS:CORR:COLL:CKIT:ORD:LOAD, etc.

-104

Data type error

The parser has recognized a data element that must not exist. Block data has been sent instead of numeric value data or character string data that had been expected, for example.

E

32

Ecal module not in appropriate RF path

This error occurs when an ECal command, SENS:CORR:COLL:ECAL:SOLTn, is executed with the port on the ECal module not connected correctly to the instrument.

-200

Execution error

An error associated with execution has been generated for which this instrument cannot specify the error message. This code shows that an error associated with execution defined in 11.5.1.1.5, IEEE488.2 has occurred. This error occurs also when a calibration measurement is aborted.

-123

Exponent too large

The absolute value of the exponent exceeds 32,000 (see 7.7.2.4.1, IEEE488.2).

-178

Expression data not allowed

An expression-data element has been received at a position where this instrument does not accept one.

-170

Expression error

When the expression data is put to syntactic analysis, an error not corresponding to one of Error Numbers -171 through -179 occurs.

Error Messages

Error number: 31

F

- 31 **Failed to configure ECal module**
This error occurs when the control of the ECal module fails at time of executing an ECal command, SENS:CORR:COLL:ECAL:SOLTn. The failure results from the failure to connect the ECal module to the USB port, failure of the ECal module, etc.
- 76 **Failed to configure multiport test set**
This error occurs when multiport test set control is enabled (SENS:MULT ON) and the analyzer fails to control the test set. Make sure the analyzer and the test set are connected with the parallel cable, and the test set is powered on.
- 102 **Failed to copy file**
This error occurs when copying a file (MMEM:COPY command) fails.
- 104 **Failed to create directory**
This error occurs when creating a directory (MMEM:MDIR command) fails.
- 103 **Failed to delete file**
This error occurs when deleting a file (MMEM:DEL command) fails.
- 100 **Failed to read file**
This error occurs when a 2-port touchstone file (CALC:FSIM:SEND:PMC:PORT:USER:FIL command), the formatted data array (MMEM:LOAD:FDAT command) and limit table (MMEM:STOR:LIM command) for the active trace on the active channel, segment sweep table (MMEM:LOAD:SEGM command) for the active channel, a VBA project file (MMEM:LOAD:PROG command), etc. cannot be read normally.
- 101 **Failed to write file**
This error occurs when the formatted data array (MMEM:STOR:FDAT command) and limit table (MMEM:STOR:LIM command) for the active trace on the active channel, segment sweep table (MMEM:STOR:SEGM command) for the active channel, display image (MMEM:STOR:IMAG command) for the LCD screen, a VBA project file (MMEM:STOR:PROG command), etc. cannot be written normally.
- 54 **Fault location not allowed**
This error occurs when the fault location function is enabled when the sweep type is not set to linear or the number of measurement points is two. The fault location function is available only when linear sweep with more than two measurement points.
- 257 **File name error**
A file name error. This message appears when an error exists in the file name and hence a command is not executed correctly. This error occurs when you try to copy to an unsuitable file name, for example.
- 256 **File name not found**
The file name specified is not found and hence the command is not executed correctly. This error occurs when you try to read a file that does not exist in a disk or a disk is not correctly inserted into the drive to read or write a file, for example.
- 107 **File transfer failed**
This error occurs when writing data into or reading data from a file (MMEM:TRAN

command) fails.

G

-105 **GET not allowed**

A group execution trigger (GET) has been received in the program message (see 7.7, IEEE488.2).

H

-114 **Header suffix out of range**

The unit of the header is outside the range. The header is invalid in the unit for numeric parameters following a SCPI command.

I

-224 **Illegal parameter value**

The parameter value is not suitable. This error occurs when the CALC:PAR:DEF command is used to specify an S-parameter that does not exist in the model.

-282 **Illegal program name**

This error occurs when a nonexistent VBA program name is specified by the PROG:SEL:NAME command.

-213 **Init ignored**

Because another measurement is in progress, the request for initiating a measurement (“INIT” command) is ignored.

-161 **Invalid block data**

Block data has been expected, but the block data that appears is invalid for some reason (see 7.7.6.2, IEEE488.2). The END message is received before the length of block data has been filled, for example.

-101 **Invalid character**

An invalid character exists in the program message character string.

-141 **Invalid character data**

An invalid character is found in the character data element, or the parameter received is not valid.

-121 **Invalid character in number**

A character that is invalid for the data type subject to syntactic analysis has been received. For example, a letter is found in a decimal numeric value or a numeric character “9” in octal data.

-171 **Invalid expression**

The expression-data element is invalid (see 7.7.7.2, IEEE488.2). Parentheses are not paired, or illegal characters are used, for example.

-103 **Invalid separator**

The parser (a syntactic analysis program) had been expecting a delimiter, but a character

Error Messages

Error number: -151

that is not a delimiter has been sent.

-151

Invalid string data

Character string data has been expected, but the character string data that appears is invalid for some reason (see 7.7.5.2, IEEE488.2). The END message is received before the ending quotation mark character appears, for example.

-131

Invalid suffix

The suffix does not comply with the syntax defined in 7.7.3.2, IEEE488.2. Or it does not suit 4294A.

L

53

Log sweep requires 2 octave minimum span

The span of sweep range is not satisfied the requirement for logarithmic sweep. The sweep type is automatically changed to linear sweep when this error occurs.

For example, this error occurs when, with the start and stop frequency are set 1 MHz and 2 MHz respectively, the sweep type is changed to logarithmic sweep.

Set the stop frequency to more than four times as many as the start frequency. And then select logarithmic sweep.

M

-109

Missing parameter

The number of parameters is less than that required for the command, or the parameter has not been entered. For example, the command SENS{1-4}:SWE:POIN requires one more parameter.

Therefore, when a message “SENS1:SWE:POIN” is sent to a correct program message “SENS1:SWE:POIN 201” this instrument receives the former message as an invalid one because all parameters have not been entered. Enter command parameters correctly.

75

Multiport test set not enabled

This error occurs when multiport test set calibration is performed while test set control is not enabled.

N

56

Not enough points for connector model

This error occurs when the connector measurement function of the SRL measurement is performed with the number of measurement points less than 101. Use at least 101 points.

52

No valid memory trace

This error occurs when there is no valide memory trace data and :DISP: WIND:TRAC:MEM ON or DISP:WIND:TRAC:STAT ON is received or parameters other than “NORM” is set with CALC:MATH:FUNC.

-120

Numeric data error

An error resulting from the numeric value data (including numeric value data having no

decimal point representation) has occurred. A numeric value error other than Errors -121 through -129 has occurred.

-128

Numeric data not allowed

An numeric-value-data element (not violating the standard) has been received at a position where this instrument does not accept one.

O

200

Option not installed

The command received has been ignored because of the mismatch between the contents of an option for this instrument and the command.

For example, this error occurs when the source attenuator (power range) is set at a value other than zero (SOUR:POW:ATT command) in a model not having the extended power output option.

This error is not generated by front key operations.

-225

Out of memory

Insufficient memory is available in this instrument to perform the required operation.

P

-220

Parameter error

When a parameter-related error other than Errors -221 through -229 occurs, that error is displayed.

-108

Parameter not allowed

The number of parameters exceeds that required for the command.

For instance, when a program message “:SENS1:SWE:TYPE LIN, SEGM” is sent instead of a correct program message with a command “:SENS1:SWE:TYPE LIN” which requires a parameter, the instrument receives the message as the number of parameters is invalid. See the command reference to confirm the required number of parameters.

41

Peak not found

This error occurs when, after specifying a peak and executing the CALC:MARK:FUNC:EXEC and CALC:FUNC:EXEC commands, the specified peak is not found in the marker search analysis.

220

Phase lock loop unlocked

This error occurs when the PLL circuit of this instrument becomes unlocked while the measurement is in progress. The measurement value is not correct. This error may occur when an external reference out of specification is connected to this instrument. Should an error occur with an external reference not connected, this instrument is faulty. Contact an Agilent Technology sales office or the company from which you bought the instrument.

221

Port 1 receiver overload

The input to Test Port 1 exceeds the maximum input level. The measurement value is not correct. When a DUT is an amplifier or the like, this error may occur, damaging the receiver in the worst case. Should this error occur with a passive part used as the DUT or with nothing connected to the test port, this instrument is faulty. Contact an Agilent

Error Messages

Error number: 222

Technology sales office or the company from which you bought the instrument.

If this error occurs, the stimulus signal output is automatically turned to off.

222

Port 2 receiver overload

The input to Test Port 2 exceeds the maximum input level. The measurement value is not correct. When a DUT is an amplifier or the like, this error may occur, damaging the receiver in the worst case. Should this error occur with a passive part used as the DUT or with nothing connected to the test port, this instrument is faulty. Contact an Agilent Technology sales office or the company from which you bought the instrument.

If this error occurs, the stimulus signal output is automatically turned to off.

241

Power on test failed

This error occurs when the power-on test fails, indicating a failure of this instrument. Contact an Agilent Technology sales office or the company from which you bought the instrument.

61

Power unlevelled

The out power level exceeds available range.

For example, if the level after correction exceeds the power level that can be outputted when correcting the power level with the power slope feature, this error occurs.

Check that the power level is set correctly, and the correction value of the power slope is set correctly.

120

Printer error

This error occurs when the previous printing is still in progress or the printer fails (offline, short of paper, etc.) at time of outputting the display image on the LCD screen to the printer (HCOP:IMM command).

121

Print failed

This error occurs when printing fails for reasons other than Error 120, Printer error.

-284

Program currently running

This error occurs when the PROG:SEL:STAT RUN command is executed with the VBA program in the Run state.

-112

Program mnemonic too long

The length of the header exceeds 12 characters (see 7.6.1.4.1, IEEE488.2).

-286

Program runtime error

An error occurring when VBA is executed.

Q

-430

Query DEADLOCKED

The state that generates a “DEADLOCKED” Query error (see 6.3.1.7, IEEE488.2). This error occurs when both input and output buffers have become full, preventing the instrument from continuing processing, for example.

-400

Query error

A comprehensive query error has occurred showing that this instrument cannot detect a

more detailed error. This code simply shows that a query error defined in 11.5.1.1.7 and 6.3, IEEE488.2 has occurred.

-410

Query INTERRUPTED

The state that generates a “INTERRUPTED” Query error (see 6.3.2.3, IEEE488.1). This error occurs when data bytes (DAB) or GET are received before the transmission of the response after a query has not been completed, for example.

-420

Query UNTERMINATED

The state that generates an “UNTERMINATED” Query error (see 6.3.2, IEEE488.2). This error occurs when this instrument is designated as the talker and an incomplete program message is received, for example.

-440

Query UNTERMINATED after indefinite response

After a query asking for an indefinite response has been run, another query is received in the same program message (See 6.5.7.5.7, IEEE488.2).

R

105

Recall failed

This error occurs when reading an instrument status file (State01.sta, etc.) (MMEM:LOAD:STAT command) fails.

S

106

Save failed

This error occurs when writing an instrument status file (State01.sta, etc.) (MMEM:STOR:STAT command) fails.

50

Specified channel hidden

This error occurs when an attempt is made to activate a channel not on display using the DISP:WIND:ACT command. This error is not generated by front key operations.

23

Specified error term dose not exist

21

Specified ports overlapped

This error occurs when a port number is duplicated in a command requiring two or more port numbers as parameters. Specify port setup correctly to avoid duplication of ports. This error is not generated by front key operations.

51

Specified trace dose not exist

-150

String data error

When a character-string-data element is put to syntactic analysis, an error not corresponding to one of Error Numbers -151 through -159 occurs.

-158

String data not allowed

A character-string-data element has been received at a position where this instrument does not accept one.

Error Messages

Error number: -138

-138 **Suffix not allowed**
A suffix is attached to a numeric value element to which a suffix is not allowed to be attached.

-134 **Suffix too long**
The unit is too long.
The unit is expressed in 12 or more characters (see 7.7.3.4, IEEE488.2).

-102 **Syntax error**
A command or data type that is not recognized exists.

-310 **System error**
One of the errors designated as “system errors” in this instrument has occurred.

T

40 **Target value not found**
This error occurs when the target is not found during the marker search analysis after specifying the target and executing the CALC:MARK:FUNC:EXEC and CALC:FUNC:EXEC commands. This error occurs also when the bandwidth is not found after executing the bandwidth marker command, CALC:MARK:BWID:DATA?

-124 **Too many digits**
The number of digits of the argument of the decimal numeric-value-data element exceeds 255 with the preceding 0 removed (see 7.7.2.4.1, IEEE488.2).

-223 **Too much data**
The block-, expression-, or character-string-type program data that has been received conforms with the standard. But it exceeds the amount that can be processed under the condition of the memory or conditions specific to memory-related devices. In this instrument, this error occurs when the number of characters exceeds 254 in a character-string parameter.

-211 **Trigger ignored**
This instrument receives and detects a trigger command (“TRIG”) or an external trigger signal. But it is ignored due to the timing condition (This instrument is not in the wait-for-trigger state, for example). Change the setup so that a trigger command or an external trigger signal can be sent after the instrument has entered the wait-for-trigger state.

U

-113 **Undefined header**
A command not defined in this instrument, though not illegal in the syntactic structure, has been received. For example, when a message “:DISP:WIND1:TABL:MEM ON” is sent to a correct program message “:DISP:WIND1:TRAC1:MEM ON,” the message sent is received as an undefined command by this instrument. See the command reference and use correct commands.

This error occurs also when a port not existing on this model is specified in a command specifying a port number as an index. Such commands are
CALC:FSIM:SEND:DEEM:PORTn:xxxx, CALC:FSIM:SEND:PMC:PORTn:xxxx,

CALC:FSIM:SEND:ZCON:PORTn:Z0:R, and SENS:CORR:EXT:PORTn:TIME; they include PORTn as a part.

Error Messages

Error number:

Warning Message

A warning message is displayed in the instrument message/Warning area in the lower left part of the display against a gray background. Pushing a front panel key or executing **:DISP:CCL** command clears the message.

This message simply appears on the display, being not known to a remote environment such as a GPIB. This message is not displayed when another error (against a red background) has already been displayed in the instrument message/Warning area.

The warning messages for this instrument are as follows:

Cable Z out of range

This error occurs in SRL measurement function when measured average impedance is out of the tolerance (system impedance +/- 30%), and the SRL calculation is not valid.

Fault location not allowed

This warning message is displayed when the gating/transform function of time domain function is turned on, number of points is set 2 or sweep type is set logarithmic/segment sweep.

The gating function and transform function are automatically turned off when this warning message is displayed.

Log sweep requires 2 octave minimum span

If you change the sweep range that does not satisfy the necessary condition of the frequency span (the stop frequency is about 4 times or more of the start frequency) when the sweep type is set to the log sweep, this message is displayed.

If this message is displayed, the sweep type is automatically set to the linear sweep.

For example, if you attempt to change the log type to the log sweep when the start frequency is set to 1 MHz and the stop frequency to 2 MHz, this error occurs.

Set the stop frequency to a value of about 4 times or more the start frequency and then set the low sweep.

Peak not found

This warning message is displayed when, with the tracking turned on, the peak specified by the marker search has not been found by the time the sweep is finished (with the tracking executed).

Segment table changed

This warning message is displayed when the setting specified segment by segment in the segment table is automatically changed by a change in the other setting.

For example, this warning message is displayed when, with the power specified segment by segment in the segment table, the power setting for a segment is adjusted by a change in the power range setting.

Target value not found

This warning message is displayed when, with the tracking turned on, the target specified by the marker search has not been found by the time the sweep is finished (with the tracking executed).

This warning message is displayed also when, with the bandwidth marker displayed, the setting for the bandwidth marker is changed at the end of the sweep, or when, with the

active marker changed or moved, the bandwidth is not found.

User Preset File not found

This warning message is displayed if no user preset file (D:\UserPreset.sta) exists when executing the **:SYST:UPR** command.

If this message is displayed, a normal preset (**:SYST:PRES**) will be performed.

Error Messages
Error number:

Numerics

24-bit I/O port, 146

A

A:, 130

Active channel, 38

Active low, 147

Active trace, 38

Address

 GPIB address, 26

 IP address, 27

 SICL-LAN address, 28

Agilent I/O Libraries, 28

Allocation, 42

Analog measurement, 148

Analysis command, 91

Analysis results, 92

Analysis(search) range, 91

Analysis(search) type

 Analysis command, 91

Aperture

 Smoothing aperture, 45

Application Programs, 167

Arbitrary impedance, 62

ASCII transfer format, 103

Auto recall, 130

Auto scale, 46

autorec.sta, 130

Average

 Analysis command, 91

 Statistical analysis, 98

Averaging, 41

B

bandwid.htb, 96

Bandwidth, 40

Bandwidth definition value, 95

Bandwidth search, 95

Basic measurement

 Sample program, 168

Beeper

 Generates a beep

 Completion of the operation, 471

 Notification of warning/limit test result, 472

 Turns on/off

 Completion of the operation, 471

 Notification of warning/limit test result, 472

Binary transfer format

 byte order, 105

 format, 104

Bit definitions

 Operation status register, 516

 Questionable limit channel{1-4} status register, 518, 519, 520

 Questionable limit status register, 518

 Questionable status register, 516

 Standard event status register, 515

 Status byte register, 514

Bitmap, 131

Bus trigger, 79

Byte order, 105

C

C0, 62

C1, 62

C2, 62

C3, 62

cal.htb, 69

Calibration

 Sample program, 65

Calibration coefficient arrays, 108

 Saving/recalling, 130

Calibration coefficients

 Calculating, 60

Calibration data, 58

Calibration Kit, 58, 62

Calibration kit name, 62

Calibration property, 409

Calibration type

 Checking the applied calibration type, 61

 Selecting, 58

Center frequency

 Bandwidth search, 95

 Notch search, 97

Center value

 Frequency sweep range, 39

 Power sweep range, 41

Channel display, 42

Characteristic impedance, 41

Class assignment, 63

Class Module

 Importing, 132

Clear

 Averaging, 41

 Echo window, 47

 Error message display, 302

 Error queue, 194

 Status registers, 194

Clock

 turning on or off screen display, 47

Command tree, 484

 Concepts, 34

Communication with external instruments, 145

Condition register, 506

cont_upd.htb, 163

Continuous initiation mode, 80

Control over SICL-LAN server, 28

Controlling over LAN

 Using SICL-LAN server, 174

 Using telnet server, 182

Copy

 File, 137

 The data trace to the memory trace, 45

Corrected data arrays, 106
 Saving/recalling, 130
Corrected memory arrays, 106
Creating directory, 137
ctrl_lan.xls, 182
ctrl_lansicl.xls, 174
CW frequency, 41

D

Data arrays
 Corrected, 106
 Formatted, 107
Data flow, 106
Data format, 45
Data math operations, 45
Data trace, 45
Data transfer format, 102
Date display
 On/off, 47
Defining a peak
 Analysis command, 91
 Marker search, 90
Defining a target
 Analysis command, 92
 Marker search, 90
Delay time
 Port extension, 408
 Sweep delay time, 40
Delete, 137
Delta marker(Reference marker), 88
Detecting Occurrence of an Error, 164
Device selector, 26
Difference between the maximum and minimum values
 Analysis command, 91
 Statistical analysis, 98
Directory
 Creating, 137
 Deleting, 137
 Retrieving file property, 137
Disabling the network function, 27
Discrete mode, 265
Display of the calibration property, 409
Display scale, 46
Display update on/off
 screen display, 47
Divisions, 46
documentation map, 4

E

ECal, 61
 Sample program, 73
ecal.htb, 75
Echo window
 printing a message, 47
 Showing/hiding, 44
Electrical Characteristics
 Input signal, 156

 Output signal, 157
 Power supply, 157
Electrical delay time, 211
Electronic calibration, 61
Enable register, 505
Enabling the network function, 27
Equivalent key to SCPI command, 193
Error correction, 60
Error detection, 164
Error message
 Clear, 302
 Reading method, 164
Error Messages, 524
Error queue, 164
 Clear, 194
Event register, 505
Ex_3_1.sta, 50
Ex_4_1.sta, 65
Ex_4_2.sta, 73
Expanded phase format, 45
Extension, 130
External reference signal, 418
External trigger, 79

F

F/W version, 196
Fail display
 Showing/hiding, 118
File
 Copying, 137
 Deleting, 137
 Retrieving file property, 137
 Saving/recalling, 130
 Transferring
 Command, 137
 Sample program, 138
file_sav.htb, 135
file_xfr.htb, 141
Firmware version, 196, 498
Fixed frequency, 41
Flexible disk, 130
Flow
 Data flow, 106
Folder
 Creating, 137
 Deleting, 137
Formatted data arrays, 107
 Saving, 131
Formatted memory arrays, 108
Frequency base, 333
Front panel key
 Equivalent key to SCPI command, 193
Full n-port calibration, 58
Full scale value, 46

G

GPIO, 25

-
- GPIB address, 26
 - GPIB remote control system, 25
 - Graph
 - Layout, 42
 - Maximizing, 42
 - Graph horizontal axis, 333
 - Graticule label, 46
 - Group delay format, 45
- H**
- Handler I/O port
 - Inputting/outputting data, 150
 - Overview, 146
 - Pin layout, 147
 - Timing chart, 153
 - handler.htb, 158
 - Hiding frequency labels, 47
 - Hold state, 79
 - How to use this manual, 20
- I**
- Idle state, 80
 - IEEE 32-bit floating point format, 105
 - IEEE 64-bit floating point format, 104
 - IF bandwidth, 40
 - Images on the LCD screen
 - Saving, 131
 - Imaginary format, 45
 - Importing, 132
 - INDEX, 148
 - Information
 - Product information, 196
 - Property of file, 137
 - Initialization
 - Error queue, 194
 - Instrument setting, 197, 477, 481
 - Status registers, 194
 - Initiate state, 80
 - Inputting data
 - Handler I/O port, 150
 - Trace(formatted data array), 113
 - Installation and Quick Start Guide, 4
 - Instrument status
 - Saving/recalling, 130
 - Internal clock
 - Turning on or off screen display, 47
 - Internal data arrays, 106
 - Internal data processing, 106
 - Internal trigger, 79
 - IP address, 27
 - Isolation, 58
- K**
- Key lock feature, 160
- L**
- L0, 62
 - L1, 62
 - L2, 62
 - L3, 62
 - LAN remote control system, 27
 - lim_test.htb, 126
 - Limit Lines
 - Configuring, 118
 - Showing/hiding, 118
 - Limit table
 - Saving/recalling, 132
 - Setting, 118
 - Showing/hiding, 44
 - Limit test, 117
 - Turning on or off, 118
 - Limit test result write strobe signal, 149
 - Linear magnitude format, 45
 - Linear sweep, 39
 - List(segment) sweep, 40
 - LOAD, 63
 - Loading, 132
 - Local key, 36
 - Logarithmic magnitude format, 45
 - Looking up commands, 20
 - Loss
 - Bandwidth search, 95
 - Notch search, 97
- M**
- Macro(VBA)
 - Control, 365
 - Saving/loading, 132
 - Managing Files, 137
 - Manual change, 498
 - Manual printing history, 2
 - Manual trigger, 79
 - Manufacture, 196
 - Marker
 - How to use, 88
 - List, 44
 - Marker list table, 44
 - Marker search, 89
 - range, 89
 - Math operations, 45
 - Maximizing a window and a graph, 42
 - Maximum value search
 - Analysis command, 91
 - Marker search, 89
 - meas_bpf.htb, 171
 - Measurement data
 - Saving, 131
 - Measurement parameters, 39
 - Measurement state, 80
 - Measuring a band pass filter, 168
 - Measuring the calibration data, 58
 - Memory arrays

- Corrected, 106
- Formatted, 108
- Memory trace, 45
- Message terminator, 35
- Minimum value search
 - Analysis command, 91
 - Marker search, 89
- Model number, 196

- N**
- Name
 - Calibration kit, 62
 - Standard, 62
- Negative logic, 147
- Negative transition filter, 506
- Network function
 - Enabling/disabling, 27
- Notch search, 97
- Notch Value, 97
- Number of measurement points, 40
 - Reading out
 - Linear sweep, 423
 - Segment sweep, 421
- Number of traces, 39

- O**
- Obtaining test results, 119
 - Each channel, 120
 - Each measurement point, 119
 - Each trace, 119
 - Overall test result, 122
- Offset delay, 62
- Offset loss, 62
- Offset Z0, 62
- OPEN, 63
- Operation status register, 507
 - Bit definitions, 516
 - Reading out the condition register, 439
 - Reading out the event register, 439
 - Setting the enable register, 440
 - Setting the negative transition filter, 441
 - Setting the positive transition filter, 442
- Operational Manual, 4
- Order base, 333
- Output port write strobe signal, 149
- Outputting data
 - Handler I/O port, 150
 - Internal data arrays, 109
- Overall test result, 122

- P**
- parameter
 - SCPI command, 193
- PASS FAIL STROBE, 149
- Pass/Fail test, 117
- Peak excursion value, 90, 91

- Peak search
 - Analysis command, 91
 - Marker search, 89
- Performing a calibration, 58
- Phase format, 45
- Pin layout, 147
- Polar format, 45
- Polarity
 - Analysis command, 91
 - Marker search, 90
- Port
 - Handler I/O port, 150
- Port 23, 32
- Port 5025, 33
- Port extension, 407, 408
- Positive transition filter, 506
- Power, 40
- Power range, 40
- Power slope, 40
- Power sweep, 41
- Prefix, 498
- Preset, 197, 477, 481
- Primary value, 107
- Printer
 - Aborts the print output, 337
 - Outputs the display image, 337
 - Selects the print color, 337
- Product information, 196
- Program (sample)
 - file name
 - bandwid.htb, 96
 - cal.htb, 69
 - cont_upd.htb, 163
 - ctrl_lan.xls, 182
 - ctrl_lansicl.xls, 174
 - ecal.htb, 75
 - file_sav.htb, 135
 - file_xfr.htb, 141
 - handler.htb, 158
 - lim_test.htb, 126
 - meas_bpf.htb, 171
 - read_asc.htb, 110
 - read_bin.htb, 112
 - search.htb, 94
 - setup.htb, 54
 - srq_err.htb, 166
 - srq_meas.htb, 84
 - trg_sing.htb, 86
 - write_a.htb, 114
 - write_b.htb, 116
 - title
 - Bandwidth Search, 96
 - Calibration, 69
 - Communicating with external instruments, 158
 - Configuring measurement conditions, 54
 - Controlling the update timing of LCD display, 163
 - Controlling using SICL-LAN server, 174

- Controlling using telnet server, 182
 - ECal, 75
 - Error detection using an SRQ, 166
 - File transfer, 141
 - Limit test, 126
 - Measurement of band pass filter, 171
 - Peak search, 94
 - Saving file, 135
 - Using an SRQ to detect the end of measurement, 84
 - Using the :TRIG:SING command to wait until end of measurement, 86
 - Using the ASCII transfer format to retrieve internal data arrays, 110
 - Using the ASCII transfer format to write formatted data arrays, 114
 - Using the binary transfer format to retrieve internal data arrays, 112
 - Using the binary transfer format to write formatted data arrays, 116
 - Program message terminator, 35
 - Program(VBA)
 - Control, 365
 - Saving/loading, 132
 - Programming Manual, 4
 - Property display
 - Calibration, 409
 - Property of file, 137
 - Pulse width, 153
- Q**
- Q value, 95, 97
 - Questionable bandwidth limit channel{1-16} status register
 - Reading out the condition register, 444
 - Reading out the event register, 444
 - Setting the enable register, 445
 - Setting the negative transition filter, 446
 - Setting the positive transition filter, 447
 - Questionable bandwidth limit status register
 - Reading out the condition register, 447
 - Reading out the event register, 443
 - Setting the enable register, 448
 - Setting the negative transition filter, 449
 - Setting the positive transition filter, 450
 - Questionable limit channel{1-4} status register
 - Bit definitions, 518, 519, 520
 - Reading out the condition register, 453
 - Reading out the event register, 453
 - Setting the enable register, 454
 - Setting the negative transition filter, 455
 - Setting the positive transition filter, 456
 - Questionable limit channel{1-9} status register, 507
 - Questionable limit status register, 507
 - Bit definitions, 518
 - Reading out the condition register, 457
 - Reading out the event register, 453
 - Setting the enable register, 458
 - Setting the negative transition filter, 459
 - Setting the positive transition filter, 460
 - Questionable ripple limit channel{1-16} status register
 - Reading out the condition register, 463
 - Reading out the event register, 463
 - Setting the enable register, 464
 - Setting the negative transition filter, 465
 - Setting the positive transition filter, 466
 - Questionable ripple limit status register
 - Reading out the condition register, 466
 - Reading out the event register, 463
 - Setting the enable register, 467
 - Setting the negative transition filter, 468
 - Setting the positive transition filter, 469
 - Questionable status register, 507
 - Bit definitions, 516
 - Reading out the condition register, 451
 - Reading out the event register, 443
 - Setting the enable register, 452
 - Setting the negative transition filter, 461
 - Setting the positive transition filter, 462
 - Quick Start Guide, 4
- R**
- read_asc.htb, 110
 - read_bin.htb, 112
 - READY FOR TRIGGER, 148
 - Real format, 45
 - Recall, 130
 - Auto recall, 130
 - Ref In connector, 418
 - Reference graticule line, 46
 - Reference marker, 88
 - Releasing key lock, 160
 - Remote control system
 - GPIB remote control system, 25
 - LAN remote control system, 27
 - Overview, 24
 - Remote mode, 36
 - Reset
 - Instrument setting, 197, 477, 481
 - Status registers, 194
 - Response calibration, 58
 - Restart, 41
 - Retrieving file property, 137
 - Retrieving measurement results
 - All measurement points, 109
 - Specified point, 88
 - Retrieving search(analysis) results, 92
 - RF Out
 - On/Off, 39
- S**
- S parameter, 39
 - Sample Application Programs, 167
 - Sample Program, 3
 - file name
 - bandwid.htb, 96

- cal.htb, 69
- cont_upd.htb, 163
- ctrl_lan.xls, 182
- ctrl_lansicl.xls, 174
- ecal.htb, 75
- file_sav.htb, 135
- file_xfr.htb, 141
- handler.htb, 158
- lim_test.htb, 126
- meas_bpf.htb, 171
- read_asc.htb, 110
- read_bin.htb, 112
- search.htb, 94
- setup.htb, 54
- srq_err.htb, 166
- srq_meas.htb, 84
- trg_sing.htb, 86
- write_a.htb, 114
- write_b.htb, 116
- How to load, 21
- title
 - Bandwidth Search, 96
 - Calibration, 69
 - Communicating with external instruments, 158
 - Configuring measurement conditions, 54
 - Controlling the update timing of LCD display, 163
 - Controlling using SICL-LAN server, 174
 - Controlling using telnet server, 182
 - ECal, 75
 - Error detection using an SRQ, 166
 - File transfer, 141
 - Limit test, 126
 - Measurement of band pass filter, 171
 - Peak search, 94
 - Saving file, 135
 - Using an SRQ to detect the end of measurement, 84
 - Using the :TRIG:SING command to wait until end of measurement, 86
 - Using the ASCII transfer format to retrieve internal data arrays, 110
 - Using the ASCII transfer format to write formatted data arrays, 114
 - Using the binary transfer format to retrieve internal data arrays, 112
 - Using the binary transfer format to write formatted data arrays, 116
- Save, 130
- Scale per division, 46
- SCPI Command
 - :CALCulate{1-4}[:SElected]:MARKer:MATH:FLATness[:STATE], 253
 - :CALCulate{1-4}[:SElected]:MARKer:MATH:FSTatistics[:STATE], 255
 - :CALCulate{1-4}[:SElected]:MARKer:MATH:STATistics[:STATE], 257
- SCPI command
 - *CLS, 194
 - *ESE, 195
 - *ESR?, 195
 - *IDN?, 196
 - *OPC, 196
 - *OPC?, 196
 - *OPT?, 197
 - *RST, 197
 - *SRE, 198
 - *STB?, 199
 - *TRG, 199
 - *WAI, 199
 - :ABORt, 200
 - :CALCulate{1-4}:PARAmeter:COUNT, 282
 - :CALCulate{1-4}:PARAmeter{1-4}:DEFine, 283
 - :CALCulate{1-4}:PARAmeter{1-4}:SELect, 284
 - :CALCulate{1-4}[:SElected]:BLIMit:DB, 202
 - :CALCulate{1-4}[:SElected]:BLIMit:DISPlay:MARKer, 203
 - :CALCulate{1-4}[:SElected]:BLIMit:DISPlay:VALue, 204
 - :CALCulate{1-4}[:SElected]:BLIMit:FAIL, 205
 - :CALCulate{1-4}[:SElected]:BLIMit:MAXimum, 206
 - :CALCulate{1-4}[:SElected]:BLIMit:MINimum, 207
 - :CALCulate{1-4}[:SElected]:BLIMit:REPort[:DATA]?, 208
 - :CALCulate{1-4}[:SElected]:BLIMit[:STATE], 201
 - :CALCulate{1-4}[:SElected]:CONVersion:FUNCTion, 210
 - :CALCulate{1-4}[:SElected]:CONVersion[:STATE], 209
 - :CALCulate{1-4}[:SElected]:CORRection:EDELay:TIME, 211
 - :CALCulate{1-4}[:SElected]:CORRection:OFFSet:PHASe, 212
 - :CALCulate{1-4}[:SElected]:DATA:FDATA, 213
 - :CALCulate{1-4}[:SElected]:DATA:FMEMemory, 214
 - :CALCulate{1-4}[:SElected]:DATA:SDATA, 215
 - :CALCulate{1-4}[:SElected]:DATA:SMEMory, 216
 - :CALCulate{1-4}[:SElected]:FORMat, 217
 - :CALCulate{1-4}[:SElected]:FUNCTion:DATA?, 219
 - :CALCulate{1-4}[:SElected]:FUNCTion:DOMain:COUPlE, 221
 - :CALCulate{1-4}[:SElected]:FUNCTion:DOMain:STARt, 222, 245
 - :CALCulate{1-4}[:SElected]:FUNCTion:DOMain[:STATE], 220, 243
 - :CALCulate{1-4}[:SElected]:FUNCTion:DOMain:STOP, 223
 - :CALCulate{1-4}[:SElected]:FUNCTion:EXECute, 223
 - :CALCulate{1-4}[:SElected]:FUNCTion:PEXECursion, 224
 - :CALCulate{1-4}[:SElected]:FUNCTion:POINTs?, 225
 - :CALCulate{1-4}[:SElected]:FUNCTion:PPOLarity, 226
 - :CALCulate{1-4}[:SElected]:FUNCTion:TARGet, 227
 - :CALCulate{1-4}[:SElected]:FUNCTion:TTRansition, 228
 - :CALCulate{1-4}[:SElected]:FUNCTion:TYPE, 229
 - :CALCulate{1-4}[:SElected]:LIMit:DATA, 231

- :CALCulate{1-4}[:SElected]:LIMit:DISPlay:CLIP, 234
- :CALCulate{1-4}[:SElected]:LIMit:DISPlay[:STATe], 233
- :CALCulate{1-4}[:SElected]:LIMit:FAIL, 235
- :CALCulate{1-4}[:SElected]:LIMit:OFFSet:AMPLitude, 236
- :CALCulate{1-4}[:SElected]:LIMit:OFFSet:MARKer, 237
- :CALCulate{1-4}[:SElected]:LIMit:OFFSet:STIMulus, 238
- :CALCulate{1-4}[:SElected]:LIMit:REPort POINTs?, 240
- :CALCulate{1-4}[:SElected]:LIMit:REPort:ALL?, 239
- :CALCulate{1-4}[:SElected]:LIMit:REPort[:DATA]?, 240
- :CALCulate{1-4}[:SElected]:LIMit[:STATe], 230
- :CALCulate{1-4}[:SElected]:MARKer:BWIDth[:STATe], 241
- :CALCulate{1-4}[:SElected]:MARKer:COUPle, 242
- :CALCulate{1-4}[:SElected]:MARKer:FUNCTion:MULT i:TYPE, 252
- :CALCulate{1-4}[:SElected]:MARKer:FUNCTion:DOMa in:COUPle, 244
- :CALCulate{1-4}[:SElected]:MARKer:FUNCTion:DOMa in:STOP, 246
- :CALCulate{1-4}[:SElected]:MARKer:NOTCh[:STATe], 259
- :CALCulate{1-4}[:SElected]:MARKer:REFerence[:STAT e], 260
- :CALCulate{1-4}[:SElected]:MARKer{1-10}:ACTivate, 262
- :CALCulate{1-4}[:SElected]:MARKer{1-10}:BWIDth:DATA?, 263
- :CALCulate{1-4}[:SElected]:MARKer{1-10}:BWIDth:THReshold, 264
- :CALCulate{1-4}[:SElected]:MARKer{1-10}:DISCrete, 265
- :CALCulate{1-4}[:SElected]:MARKer{1-10}:FUNCTion: EXECute, 266
- :CALCulate{1-4}[:SElected]:MARKer{1-10}:FUNCTion: PEXCursion, 267
- :CALCulate{1-4}[:SElected]:MARKer{1-10}:FUNCTion: PPOLarity, 268
- :CALCulate{1-4}[:SElected]:MARKer{1-10}:FUNCTion: TARGet, 269
- :CALCulate{1-4}[:SElected]:MARKer{1-10}:FUNCTion: TRACKing, 270
- :CALCulate{1-4}[:SElected]:MARKer{1-10}:FUNCTion: TTRansiion, 271
- :CALCulate{1-4}[:SElected]:MARKer{1-10}:FUNCTion: TYPE, 272
- :CALCulate{1-4}[:SElected]:MARKer{1-10}:NOTCh:DATA?, 274
- :CALCulate{1-4}[:SElected]:MARKer{1-10}:NOTCh:THReshold, 275
- :CALCulate{1-4}[:SElected]:MARKer{1-10}:SET, 276
- :CALCulate{1-4}[:SElected]:MARKer{1-10}[:STATe], 261
- :CALCulate{1-4}[:SElected]:MARKer{1-10}:X, 277
- :CALCulate{1-4}[:SElected]:MARKer{1-10}:Y?, 278
- :CALCulate{1-4}[:SElected]:MATH:FUNCTion, 279
- :CALCulate{1-4}[:SElected]:MATH:MEMorize, 279
- :CALCulate{1-4}[:SElected]:MSTATistics:DATA?, 281
- :CALCulate{1-4}[:SElected]:MSTATistics[:STATe], 280
- :CALCulate{1-4}[:SElected]:RLIMit:DATA, 285
- :CALCulate{1-4}[:SElected]:RLIMit:DISPlay:LINE, 286
- :CALCulate{1-4}[:SElected]:RLIMit:DISPlay:SElect, 287
- :CALCulate{1-4}[:SElected]:RLIMit:DISPlay:VALue, 288
- :CALCulate{1-4}[:SElected]:RLIMit:FAIL, 289
- :CALCulate{1-4}[:SElected]:RLIMit:REPort[:DATA], 290
- :CALCulate{1-4}[:SElected]:RLIMit[:STATe], 284
- :CALCulate{1-4}[:SElected]:SMOothing:APERture, 292
- :CALCulate{1-4}[:SElected]:SMOothing[:STATe], 291
- :CALCulate{1-4}[:SElected]:MARKer:FUNCTion:MULT i:PEXCursion, 247
- :CALCulate{1-4}[:SElected]:MARKer:FUNCTion:MULT i:PPOLarity, 248
- :CALCulate{1-4}[:SElected]:MARKer:FUNCTion:MULT i:TARGet, 249
- :CALCulate{1-4}[:SElected]:MARKer:FUNCTion:MULT i:TRACKing, 250
- :CALCulate{1-4}[:SElected]:MARKer:FUNCTion:MULT i:TTRansiion, 251
- :CALCulate{1-4}[:SElected]:MARKer:MATH:FLATness :DATA?, 254
- :CALCulate{1-4}[:SElected]:MARKer:MATH:FSTATistic s:DATA?, 256
- :CALCulate{1-4}[:SElected]:MARKer:MATH:STATistic s:DATA?, 258
- :CONTRol:HANDler:A[:DATA], 293
- :CONTRol:HANDler:B[:DATA], 293
- :CONTRol:HANDler:C[:DATA], 294
- :CONTRol:HANDler:C:MODE, 295
- :CONTRol:HANDler:D[:DATA], 296
- :CONTRol:HANDler:D:MODE, 297
- :CONTRol:HANDler:E[:DATA], 298
- :CONTRol:HANDler[:EXTension]:INDEX:STATe, 300
- :CONTRol:HANDler[:EXTension]:RTRigger:STATe, 301
- :CONTRol:HANDler:F[:DATA], 299
- :CONTRol:HANDler:OUTPut{1-2}[:DATA], 300
- :DISPlay:ANNotation:FREQUency[:STATe], 302
- :DISPlay:CClear, 302
- :DISPlay:CLOCK, 303
- :DISPlay:COLor{1-2}:BACK, 304
- :DISPlay:COLor{1-2}:GRATICule{1-2}, 305
- :DISPlay:COLor{1-2}:LIMit{1-2}, 306
- :DISPlay:COLor{1-2}:RESet, 306
- :DISPlay:COLor{1-2}:TRAC{1-4}:DATA, 307
- :DISPlay:COLor{1-2}:TRAC{1-4}:MEMory, 308
- :DISPlay:ECHO:CLEar, 309

- :DISPlay:ECHO[:DATA], 309
- :DISPlay:ENABle, 310
- :DISPlay:FSIGn, 311
- :DISPlay:IMAGe, 311
- :DISPlay:MAXimize, 312
- :DISPlay:SKEY[:STATe], 312
- :DISPlay:SPLit, 313
- :DISPlay:TABLE[:STATe], 314
- :DISPlay:TABLE:TYPE, 315
- :DISPlay:UPDate[:IMMEDIATE], 316
- :DISPlay:WINDow{1-4}:ACTivate, 316
- :DISPlay:WINDow{1-4}:ANNotation:MARKer:ALIGn[:STATe], 317
- :DISPlay:WINDow{1-4}:ANNotation:MARKer:SINGLE[:STATe], 318
- :DISPlay:WINDow{1-4}:LABel, 319
- :DISPlay:WINDow{1-4}:MAXimize, 320
- :DISPlay:WINDow{1-4}:SPLit, 321
- :DISPlay:WINDow{1-4}:TITLe:DATA, 322
- :DISPlay:WINDow{1-4}:TITLe[:STATe], 322
- :DISPlay:WINDow{1-4}:TRACe{1-4}:ANNotation:MARKer:POSition:X, 323
- :DISPlay:WINDow{1-4}:TRACe{1-4}:ANNotation:MARKer:POSition:Y, 324
- :DISPlay:WINDow{1-4}:TRACe{1-4}:ANNotation:YAXis:MODE, 325
- :DISPlay:WINDow{1-4}:TRACe{1-4}:MEMory[:STATe], 326
- :DISPlay:WINDow{1-4}:TRACe{1-4}:STATe, 327
- :DISPlay:WINDow{1-4}:TRACe{1-4}:Y[:SCALE]:AUTO, 327
- :DISPlay:WINDow{1-4}:TRACe{1-4}:Y[:SCALE]:PDIVisions, 328
- :DISPlay:WINDow{1-4}:TRACe{1-4}:Y[:SCALE]:RLEVel, 329
- :DISPlay:WINDow{1-4}:TRACe{1-4}:Y[:SCALE]:RPOSITION, 330
- :DISPlay:WINDow{1-4}:TRACe{1-4}:Y:TRACk:FREQuency, 331
- :DISPlay:WINDow{1-4}:TRACe{1-4}:Y:TRACk:MODE, 332
- :DISPlay:WINDow{1-4}:X:SPACing, 333
- :DISPlay:WINDow{1-4}:Y[:SCALE]:DIVisions, 334
- :FORMat:BORDER, 335
- :FORMat:DATA, 336
- :HCOpy:ABORT, 337
- :HCOpy:IMAGe, 337
- :HCOpy[:IMMEDIATE], 337
- :INITiate{1-4}:CONTinuous, 339
- :INITiate{1-4}[:IMMEDIATE], 338
- :MMEMory:CATalog?, 340
- :MMEMory:COpy, 341
- :MMEMory:DELeTe, 342
- :MMEMory:LOAD:CHANnel:COEFficient {A|B|C|D}, 345
- :MMEMory:LOAD:CHANnel[:STATe], 344
- :MMEMory:LOAD:LIMit, 346
- :MMEMory:LOAD:PROGram, 347
- :MMEMory:LOAD:RLIMit, 348
- :MMEMory:LOAD:SEGment, 349
- :MMEMory:LOAD[:STATe], 343
- :MMEMory:MDIRectory, 350
- :MMEMory:STORE:CHANnel:COEFficient {A|B|C|D}, 353
- :MMEMory:STORE:CHANnel[:STATe], 352
- :MMEMory:STORE:FDATa, 354
- :MMEMory:STORE:IMAGe, 355
- :MMEMory:STORE:LIMit, 356
- :MMEMory:STORE:PROGram, 357
- :MMEMory:STORE:RLIMit, 358
- :MMEMory:STORE:SALL, 359
- :MMEMory:STORE:SEGment, 360
- :MMEMory:STORE[:STATe], 351
- :MMEMory:STORE:STYPe, 361
- :MMEMory:TRANsfer, 362
- :OUTPut[:STATe], 363
- :PROGram:CATalog?, 363
- :PROgram[:SElected]:NAME, 364
- :PROgram[:SElected]:STATe, 365
- :SENSe:CORRection:COLLect:ECAL:PATH?, 366
- :SENSe:CORRection:IMPedance[:INPut][:MAGNitude], 367
- :SENSe{1-4}:AVERAge:CLEar, 368
- :SENSe{1-4}:AVERAge:COUNT, 369
- :SENSe{1-4}:AVERAge[:STATe], 368
- :SENSe{1-4}:BANDwidth[:RESolution], 370
- :SENSe{1-4}:BWIDth[:RESolution], 371
- :SENSe{1-4}:CORRection:CLEar, 371
- :SENSe{1-4}:CORRection:COEFficient[:DATA?], 372
- :SENSe{1-4}:CORRection:COLLect[:ACQuire]:ISOLation, 377
- :SENSe{1-4}:CORRection:COLLect[:ACQuire]:LOAD, 399
- :SENSe{1-4}:CORRection:COLLect[:ACQuire]:OPEN, 404
- :SENSe{1-4}:CORRection:COLLect[:ACQuire]:SHORT, 405
- :SENSe{1-4}:CORRection:COLLect[:ACQuire]:THRU, 406
- :SENSe{1-4}:CORRection:COLLect:CKIT:LABel, 374
- :SENSe{1-4}:CORRection:COLLect:CKIT:ORDER:LOAD, 375
- :SENSe{1-4}:CORRection:COLLect:CKIT:ORDER:OPEN, 376
- :SENSe{1-4}:CORRection:COLLect:CKIT:ORDER:SHORT, 377
- :SENSe{1-4}:CORRection:COLLect:CKIT:ORDER:THRU, 378
- :SENSe{1-4}:CORRection:COLLect:CKIT:RESet, 378
- :SENSe{1-4}:CORRection:COLLect:CKIT[:SElect], 373
- :SENSe{1-4}:CORRection:COLLect:CKIT:STAN{1-21}:ARBITrary, 379
- :SENSe{1-4}:CORRection:COLLect:CKIT:STAN{1-21}:C0, 380

- :SENSe{1-4}:CORRection:COLLect:CKIT:STAN{1-21}:C1, 381
- :SENSe{1-4}:CORRection:COLLect:CKIT:STAN{1-21}:C2, 382
- :SENSe{1-4}:CORRection:COLLect:CKIT:STAN{1-21}:C3, 383
- :SENSe{1-4}:CORRection:COLLect:CKIT:STAN{1-21}:DELay, 384
- :SENSe{1-4}:CORRection:COLLect:CKIT:STAN{1-21}:L0, 385
- :SENSe{1-4}:CORRection:COLLect:CKIT:STAN{1-21}:L1, 386
- :SENSe{1-4}:CORRection:COLLect:CKIT:STAN{1-21}:L2, 387
- :SENSe{1-4}:CORRection:COLLect:CKIT:STAN{1-21}:L3, 388
- :SENSe{1-4}:CORRection:COLLect:CKIT:STAN{1-21}:LABel, 389
- :SENSe{1-4}:CORRection:COLLect:CKIT:STAN{1-21}:LOSS, 390
- :SENSe{1-4}:CORRection:COLLect:CKIT:STAN{1-21}:TYPE, 391
- :SENSe{1-4}:CORRection:COLLect:CKIT:STAN{1-21}:Z0, 392
- :SENSe{1-4}:CORRection:COLLect:ECAL:ERES, 393
- :SENSe{1-4}:CORRection:COLLect:ECAL:ISOLation[:S TATe], 393
- :SENSe{1-4}:CORRection:COLLect:ECAL:SOLT1, 395
- :SENSe{1-4}:CORRection:COLLect:ECAL:SOLT2, 395
- :SENSe{1-4}:CORRection:COLLect:ECAL:THRU, 396
- :SENSe{1-4}:CORRection:COLLect:METHod:ERES, 397
- :SENSe{1-4}:CORRection:COLLect:METHod[:RESPonse]:OPEN, 400
- :SENSe{1-4}:CORRection:COLLect:METHod[:RESPonse]:THRU, 402
- :SENSe{1-4}:CORRection:COLLect:METHod:SOLT1, 401
- :SENSe{1-4}:CORRection:COLLect:METHod:SOLT2, 401
- :SENSe{1-4}:CORRection:COLLect:METHod:TYPE?, 403
- :SENSe{1-4}:CORRection:COLLect:METHod[:RESPonse]:SHORT, 400
- :SENSe{1-4}:CORRection:COLLect:SAVE, 405
- :SENSe{1-4}:CORRection:EXTension:PORT{1-4}, 408
- :SENSe{1-4}:CORRection:EXTension[:STATe], 407
- :SENSe{1-4}:CORRection:PROPerTy, 409
- :SENSe{1-4}:CORRection:RVELocity:COAX, 409
- :SENSe{1-4}:CORRection:STATe, 410
- :SENSe{1-4}:CORRection:TYPE{1-4}?, 411
- :SENSe{1-4}:FREQuency:CENTer, 413
- :SENSe{1-4}:FREQuency:DATA, 414
- :SENSe{1-4}:FREQuency:SPAN, 415
- :SENSe{1-4}:FREQuency:START, 416
- :SENSe{1-4}:FREQuency:STOP, 417
- :SENSe{1-4}:FREQuency[:CW], 412
- :SENSe{1-4}:ROSCillator:SOURce, 418
- :SENSe{1-4}:SEGMENT:DATA, 419
- :SENSe{1-4}:SEGMENT:SWEEp:POINts?, 421
- :SENSe{1-4}:SEGMENT:SWEEp:TIME?, 421
- :SENSe{1-4}:SWEEp:DELay, 422
- :SENSe{1-4}:SWEEp:POINts, 423
- :SENSe{1-4}:SWEEp:TIME:AUTO, 425
- :SENSe{1-4}:SWEEp:TIME[:DATA], 424
- :SENSe{1-4}:SWEEp:TYPE, 426
- :SERVice:CHANnel:ACTIve?, 426
- :SERVice:CHANnel:COUNT?, 427
- :SERVice:CHANnel:TRACe:COUNT?, 427
- :SERVice:CHANnel{1-4}:TRACe:ACTIve?, 427
- :SERVice:PORT:COUNT?, 428
- :SOURce{1-4}:POWer:ATTenuation[:DATA], 430
- :SOURce{1-4}:POWer:CENTer, 431
- :SOURce{1-4}:POWer[:LEVel][:IMMediate][:AMPLitude], 429
- :SOURce{1-4}:POWer[:LEVel]:SLOPe:STATe, 434, 435
- :SOURce{1-4}:POWer:PORT:COUPlE, 432
- :SOURce{1-4}:POWer:PORT{1-4}[:LEVel][:IMMediate][:AMPLitude], 433
- :SOURce{1-4}:POWer:SPAN, 436
- :SOURce{1-4}:POWer:START, 437
- :SOURce{1-4}:POWer:STOP, 438
- :STATus:OPERation:CONDition?, 439
- :STATus:OPERation:ENABle, 440
- :STATus:OPERation[:EVENT]?, 439
- :STATus:OPERation:NTRansition, 441
- :STATus:OPERation:PTRansition, 442
- :STATus:PRESet, 443
- :STATus:QUESTionable:BLIMit:CHANnel{1-4}:CONDition?, 444
- :STATus:QUESTionable:BLIMit:CHANnel{1-4}:ENABle, 445
- :STATus:QUESTionable:BLIMit:CHANnel{1-4}[:EVENT]?, 444
- :STATus:QUESTionable:BLIMit:CHANnel{1-4}:NTRansition, 446
- :STATus:QUESTionable:BLIMit:CHANnel{1-4}:PTRansition, 447
- :STATus:QUESTionable:BLIMit:CONDition?, 447
- :STATus:QUESTionable:BLIMit:ENABle, 448
- :STATus:QUESTionable:BLIMit[:EVENT]?, 443
- :STATus:QUESTionable:BLIMit:NTRansition, 449
- :STATus:QUESTionable:BLIMit:PTRansition, 450
- :STATus:QUESTionable:CONDition?, 451
- :STATus:QUESTionable:ENABle, 452
- :STATus:QUESTionable[:EVENT]?, 443
- :STATus:QUESTionable:LIMit:CHANnel{1-4}:CONDition?, 453
- :STATus:QUESTionable:LIMit:CHANnel{1-4}:ENABle, 454
- :STATus:QUESTionable:LIMit:CHANnel{1-4}[:EVENT]?, 453
- :STATus:QUESTionable:LIMit:CHANnel{1-4}:NTRansition, 455

- :STATus:QUEStionable:LIMit:CHANnel{1-4}:PTRansition, 456
- :STATus:QUEStionable:LIMit:CONDition?, 457
- :STATus:QUEStionable:LIMit:ENABle, 458
- :STATus:QUEStionable:LIMit[:EVENT]?, 453
- :STATus:QUEStionable:LIMit:NTRansition, 459
- :STATus:QUEStionable:LIMit:PTRansition, 460
- :STATus:QUEStionable:NTRansition, 461
- :STATus:QUEStionable:PTRansition, 462
- :STATus:QUEStionable:RLIMit:CHANnel{1-4}:CONDition?, 463
- :STATus:QUEStionable:RLIMit:CHANnel{1-4}:ENABle, 464
- :STATus:QUEStionable:RLIMit:CHANnel{1-4}[:EVENT]?, 463
- :STATus:QUEStionable:RLIMit:CHANnel{1-4}:NTRansition, 465
- :STATus:QUEStionable:RLIMit:CHANnel{1-4}:PTRansition, 466
- :STATus:QUEStionable:RLIMit:CONDition?, 466
- :STATus:QUEStionable:RLIMit:ENABle, 467
- :STATus:QUEStionable:RLIMit[:EVENT]?, 463
- :STATus:QUEStionable:RLIMit:NTRansition, 468
- :STATus:QUEStionable:RLIMit:PTRansition, 469
- :SYSTem:BACKlight, 470
- :SYSTem:BEEPer:COMPLete:IMMEDIATE, 471
- :SYSTem:BEEPer:COMPLete:STATe, 471
- :SYSTem:BEEPer:WARNIng:IMMEDIATE, 472
- :SYSTem:BEEPer:WARNIng:STATe, 472
- :SYSTem:DATE, 473
- :SYSTem:ERRor, 474
- :SYSTem:KLOCK:KBD, 475
- :SYSTem:KLOCK:MOUSE, 476
- :SYSTem:POFF, 477
- :SYSTem:PRESet, 477
- :SYSTem:SECurity:LEVel, 478
- :SYSTem:SERvice, 479
- :SYSTem:TIME, 480
- :SYSTem:UPReset, 481
- :TRIGger[:SEquence][:IMMEDIATE], 482
- :TRIGger[:SEquence]:SINGLE, 482
- :TRIGger[:SEquence]:SOURce, 483
- Command reference
 - E5061A/E5062A commands, 200
 - IEEE common commands, 194
 - Notational conventions, 192
- Command tree, 484
- Lookup, 20
- Screen display
 - update on/off, 47
- Search
 - Analysis command, 91
 - Marker search, 89
- Search range
 - Analysis command, 91
 - Marker search, 89
- Search tracking, 90
- Search type
 - Analysis command, 91
 - Marker search, 89
- search.htb, 94
- Secondary value, 107
- Segment sweep, 40
 - Total number of measurement points, 421
 - Total sweep time, 421
- Segment sweep table
 - Saving/recalling, 132
 - Setting, 40
 - Showing/hiding, 44
- Sending several commands, 35
- Serial number, 498
 - Plate, 498
 - Reading out, 196
- Service mode, 479
- Service request, 504
 - Example of use
 - Error detection, 164
 - Waiting for the end of measurement, 82
- Service request enable register, 507
 - Setting, 198
- Setting the delay time, 408
- Setting the title display area, 47
- setup.htb, 54
- SHORT, 63
- Shutdown, 477
- SICL-LAN, 28
 - Example of use, 174
- SICL-LAN address, 28
- SICL-LAN server
 - Turning on/off, 28
- Smith chart format, 45
- Smoothing, 45
- Softkey Labels
 - Showing/hiding, 44
- Source power, 40
- Span value
 - Frequency sweep range, 39
 - Power sweep range, 41
- Specifying file, 130
- SRQ, 504
 - Example of use
 - Error detection, 164
 - Waiting for the end of measurement, 82
- srq_err.htb, 166
- srq_meas.htb, 84
- Standard class assignment, 63
- Standard deviation
 - Analysis command, 91
 - Statistical analysis, 98
- Standard event status register, 507
 - Bit definitions, 515
 - Reading out the event register, 195
 - Setting the enable register, 195
- Standard module

-
- Importing, 132
 - Standard name, 62
 - Standard type, 62
 - Standard value, 62
 - Start value
 - Frequency sweep range, 39
 - Marker search range, 89
 - Power sweep range, 41
 - Search(analysis) range, 91
 - Starting a measurement, 81
 - Statistical analysis results
 - Analysis command, 92
 - Statistical analysis, 98
 - Status byte register, 505
 - Bit definitions, 514
 - Reading out, 199
 - Status register
 - Example of use
 - Error detection, 164
 - Obtaining test results, 119
 - Waiting for the end of measurement, 82
 - Register structure, 507
 - Status reporting system, 504
 - Stimulus, 39
 - Stimulus data arrays, 108
 - Stimulus signal output
 - On/Off, 39
 - Stop value
 - Frequency sweep range, 39
 - Marker search range, 89
 - Power sweep range, 41
 - Search(analysis) range, 91
 - Sweep condition, 39
 - Sweep delay time, 40
 - Sweep range, 39
 - Power sweep, 41
 - Sweep time, 40
 - Reading out
 - Linear sweep, 424
 - Segment sweep, 421
 - Sweep type, 39
 - SWR format, 45
 - System Z0, 41
- T**
- Table
 - Limit table
 - Showing/hiding, 44
 - Marker list table, 44
 - Segment sweep table
 - Setting, 40
 - Showing/hiding, 44
 - Target search
 - Analysis command, 91
 - Marker search, 89
 - telnet, 32
 - Telnet server
 - Example of use, 182
 - Turning on/off, 27
 - telnet server
 - Turning on/off, 31
 - Test results, 119
 - Each channel, 120
 - Each measurement point, 119
 - Each trace, 119
 - Overall test result, 122
 - THRU, 63
 - Time
 - Show or hide, 47
 - Timing chart, 153
 - Total number of measurement points of all segments, 421
 - Total sweep time of all segments, 421
 - Trace display, 42
 - Tracking, 90
 - Transferring files
 - Command, 137
 - Sample program, 138
 - Transition filter, 506
 - Transitional direction
 - Analysis command, 92
 - Marker search, 90
 - trg_sing.htb, 86
 - Trigger source, 79
 - Trigger system, 78
 - Triggering a measurement, 81
 - Turning on or off error correction, 60
 - Turning on or off the backlight, 47
 - Turning on or off the port extension, 407
 - Turns off the analyzer, 477
 - Typeface conventions, 3
 - Types of remote control system, 24
- U**
- Update of the LCD display, 161
 - Turning on or off, 161
 - Update once, 161
 - Update on/off
 - Screen display, 47
 - User form
 - Importing, 132
- V**
- VBA, 24
 - VBA macro
 - Control, 365
 - VBA project
 - Saving/loading, 132
 - VEE, 33
 - Velocity factor, 409
- W**
- Waiting for the end of measurement
 - Inserting wait time, 86

Using the :TRIG:SING command, 85
Using the status register, 82
Waiting for trigger state, 79
Warning Message, 534
Window
 Layout, 42
 Maximizing, 42
WinSock API
 Example of use, 182
 Overview, 33
WRITE STROBE, 149
Write strobe signal
 Limit test result, 149
 Output port, 149
write_a.htb, 114
write_b.htb, 116

Z

Z0, 41

REGIONAL SALES AND SUPPORT OFFICES

For more information about Agilent Technologies test and measurement products, applications, services, and for a current sales office listing, visit our web site: <http://www.agilent.com/find/tmdir>. You can also contact one of the following centers and ask for a test and measurement sales representative.

11/29/99

United States:

Agilent Technologies
Test and Measurement Call Center
P.O.Box 4026
Englewood, CO 80155-4026
(tel) 1 800 452 4844

(fax) (61 3) 9272 0749
(tel) 0 800 738 378 (New Zealand)
(fax) (64 4) 802 6881

Canada:

Agilent Technologies Canada Inc.
5150 Spectrum Way
Mississauga, Ontario
L4W 5G1
(tel) 1 877 894 4414

Asia Pacific:

Agilent Technologies
24/F, Cityplaza One, 1111 King's Road,
Taikoo Shing, Hong Kong
(tel) (852)-3197-7777
(fax) (852)-2506-9284

Europe:

Agilent Technologies
Test & Measurement
European Marketing Organization
P.O.Box 999
1180 AZ Amstelveen
The Netherlands
(tel) (31 20) 547 9999

Japan:

Agilent Technologies Japan Ltd.
Call Center
9-1, Takakura-Cho, Hachioji-Shi,
Tokyo 192-8510, Japan
(tel) (81) 426 56 7832
(fax) (81) 426 56 7840

Latin America:

Agilent Technologies
Latin American Region Headquarters
5200 Blue Lagoon Drive, Suite #950
Miami, Florida 33126
U.S.A.
(tel) (305) 267 4245
(fax) (305) 267 4286

Australia/New Zealand:

Agilent Technologies Australia Pty Ltd
347 Burwood Highway
Forest Hill, Victoria 3131
(tel) 1-800 629 485 (Australia)